

ТИПОВЫЕ КОНСТРУКЦИИ, ИЗДЕЛИЯ И УЗЛЫ ЗДАНИЙ И СООРУЖЕНИЙ

СЕРИЯ 1.220.1-3_м

КОНСТРУКЦИИ КАРКАСА С КОЛОННАМИ СЕЧЕНИЕМ 300Х300 мм
ДЛЯ СТРОИТЕЛЬСТВА ОБЩЕСТВЕННЫХ ЗДАНИЙ
С ИСПОЛЬЗОВАНИЕМ ВЕЧНОМЕРЗЛЫХ ГРУНТОВ ОСНОВАНИЯ
ПО ПРИНЦИПУ I

ВЫПУСК 0-1

УКАЗАНИЯ ПО ПРИМЕНЕНИЮ ИЗДЕЛИЙ СЕРИИ

ЧАСТЬ 4

ЗДАНИЯ С ТЕХНИЧЕСКИМ ПОДПОЛЬЕМ НАД ХОЛОДНЫМ ПОДПОЛЬЕМ
С ЗАЛЬНЫМИ ПРОЛЕТАМИ
СХЕМЫ ЭЛЕМЕНТОВ КАРКАСА И ТАБЛИЦЫ МАКСИМАЛЬНЫХ УСИЛИЙ

23171-04

ЦЕНА 11-40

ТИПОВЫЕ КОНСТРУКЦИИ, ИЗДЕЛИЯ И УЗЛЫ ЗДАНИЙ И СООРУЖЕНИЙ

СЕРИЯ 1.220.1-3_м

КОНСТРУКЦИИ КАРКАСА С КОЛОННАМИ СЕЧЕНИЕМ 300Х300 мм
ДЛЯ СТРОИТЕЛЬСТВА ОБЩЕСТВЕННЫХ ЗДАНИЙ
С ИСПОЛЬЗОВАНИЕМ ВЕЧНОМЕРЗЛЫХ ГРУНТОВ ОСНОВАНИЯ
ПО ПРИНЦИПУ I

ВЫПУСК 0-1

УКАЗАНИЯ ПО ПРИМЕНЕНИЮ ИЗДЕЛИЙ СЕРИИ

ЧАСТЬ 4

ЗДАНИЯ С ТЕХНИЧЕСКИМ ПОДПОЛЬЕМ НАД ХОЛОДНЫМ ПОДПОЛЬЕМ
С ЗАЛЬНЫМИ ПРОЛЕТАМИ
СХЕМЫ ЭЛЕМЕНТОВ КАРКАСА И ТАБЛИЦЫ МАКСИМАЛЬНЫХ УСИЛИЙ

РАЗРАБОТАНЫ:
ЛЕНЗНИИЭП

КИЕВЗНИИЭП

ГЛ. ИНЖ. ИН-ТА

Вад

А.В.РЯЗАНОВ

ГЛ. КОНСТР. ИН-ТА

Кле

Р.А.ПОПОВ

ГЛ. ИНЖ. ПРОЕКТА

Вик

П.Р.ВАКМАН

ЗАВ. ЛАБОРАТОРИЕЙ

Иль

Л.И.НЕЙМАК

СТ. Н. СОТРУДНИК

Сн

С.С.ШМЕЛЕВА

ЗАМ. ДИРЕКТ. ИН-ТА

Дмит

Л.Г.ДМИТРИЕВ

НАЧ. ОТДЕЛА

В.Ш

В.Н.ШЕВЧЕНКО

ГЛ. ИНЖ. ПРОЕКТА

Д.В

Д.В.ЕГУЧОВ

УТВЕРЖДЕНЫ

ГОСКОМАРХИТЕКТУРЫ

ПРИКАЗ №146 ОТ 23 МАЯ 1988 Г.

ВВЕДЕНЫ В ДЕЙСТВИЕ С 1 ИЮЛЯ 1988 Г.

ОБОЗНАЧЕНИЕ	НАИМЕНОВАНИЕ	СТР.
I.220.I-3M.0-I.4 00TO	ТЕХНИЧЕСКОЕ ОПИСАНИЕ	3
I.220.I-3M.0-I.4 19	ЗДАНИЕ ЗТ 4.4-зал(12) 4Т 4.4-зал(12)	4
I.220.I-3M.0-I.4 20	ЗДАНИЕ ЗТ 4.4-зал(24) 4Т 4.4-зал(24)	6
I.220.I-3M.0-I.4 19СБ	ЗДАНИЕ ЗТ 4.4-зал(12) 4Т 4.4-зал(12)	8
I.220.I-3M.0-I.4 20СБ	ЗДАНИЕ ЗТ 4.4-зал(24) 4Т 4.4-зал(24)	11
I.220.I-3M.0-I.4 19МУ1	ЗДАНИЕ ЗТ 4.4.30-зал(12)40-2.5	14
I.220.I-3M.0-I.4 19МУ2	ЗДАНИЕ ЗТ 4.4.30-зал(12)40-4.0	15
I.220.I-3M.0-I.4 19МУ3	ЗДАНИЕ 4Т 4.4.30-зал(12)40-2.5	17
I.220.I-3M.0-I.4 19МУ4	ЗДАНИЕ 4Т 4.4.30-зал(12)40-4.0	19
I.220.I-3M.0-I.4 20МУ1	ЗДАНИЕ ЗТ 4.4.30-зал(24)40-2.5	21
I.220.I-3M.0-I.4 20МУ2	ЗДАНИЕ ЗТ 4.4.30-зал(24)40-4.0	22
I.220.I-3M.0-I.4 20МУ3	ЗДАНИЕ 4Т 4.4.30-зал(24)40-2.5	24
I.220.I-3M.0-I.4 20МУ4	ЗДАНИЕ 4Т 4.4.30-зал(24)40-4.0	26
I.220.I-3M.0-I.4 21	ЗДАНИЕ ЗТ 6.4-зал(2x12) 4Т 6.4-зал(2x12)	28
I.220.I-3M.0-I.4 22	ЗДАНИЕ ЗТ 4.5-зал(12) 4Т 4.5-зал(12)	30
I.220.I-3M.0-I.4 21СБ	ЗДАНИЕ ЗТ 6.4-зал(2x12) 4Т 6.4-зал(2x12)	34
I.220.I-3M.0-I.4 22СБ	ЗДАНИЕ ЗТ 4.5-зал(12) 4Т 4.5-зал(12)	37
I.220.I-3M.0-I.4 21МУ1	ЗДАНИЕ ЗТ 6.4.30-зал(2x12)40-2.5	40
I.220.I-3M.0-I.4 21МУ2	ЗДАНИЕ ЗТ 6.4.30-Зал(2x12)40-4.0	41
I.220.I-3M.0-I.4 21МУ3	ЗДАНИЕ 4Т 6.4.30-зал(2x12)40-2.5	43
I.220.I-3M.0-I.4 21МУ4	ЗДАНИЕ 4Т 6.4.30-зал(2x12)40-4.0	45
I.220.I-3M.0-I.4 22МУ1	ЗДАНИЕ ЗТ 4.5.30-зал(12)32-3.5	47
I.220.I-3M.0-I.4 22МУ2	ЗДАНИЕ ЗТ 4.5.30-зал(12)40-2.5	48
I.220.I-3M.0-I.4 22МУ3	ЗДАНИЕ ЗТ 4.5.30-зал(12)40-4.0	50
I.220.I-3M.0-I.4 22МУ4	ЗДАНИЕ 4Т 4.5.30-зал(12)32-3.5	51
I.220.I-3M.0-I.4 22МУ5	ЗДАНИЕ 4Т 4.5.30-зал(12)40-2.5	53
I.220.I-3M.0-I.4 22МУ6	ЗДАНИЕ 4Т 4.5.30-зал(12)40-4.0	55
I.220.I-3M.0-I.4 23	ЗДАНИЕ ЗТ 4.6-зал(12) 4Т 4.6-зал(12)	58
	I.220.I-3M.0-I.4 00	
НАЧ.ОТД		СТАДИЯ
Н.КОНТР.		ЛИСТ
ГЛ.СПЕЦ		ЛИСТОВ
ПРОВЕРИЛ	Рудавия	Р
РАЗРАБ	Бойко	1
		3
СОДЕРЖАНИЕ		ГОСГРАЖДАНСТРОЙ
		КиевЗНИИЭП

ФОРМАТ А 4

ОБОЗНАЧЕНИЕ	НАИМЕНОВАНИЕ	СТР.
I.220.I-3M.0-I.4 24	ЗДАНИЕ ЗТ 4.7-зал(12) 4Т 4.7-зал(12)	60
I.220.I-3M.0-I.4 23СБ	ЗДАНИЕ ЗТ 4.6-зал(12) 4Т 4.6-зал(12)	63
I.220.I-3M.0-I.4 24СБ	ЗДАНИЕ ЗТ 4.7-зал(12) 4Т 4.7-зал(12)	69
I.220.I-3M.0-I.4 23МУ1	ЗДАНИЕ ЗТ 4.6.30-зал(12)40-2.5	75
I.220.I-3M.0-I.4 23МУ2	ЗДАНИЕ ЗТ 4.6.30-зал(12)40-4.0	76
I.220.I-3M.0-I.4 23МУ3	ЗДАНИЕ 4Т 4.6.30-зал(12)40-2.5	78
I.220.I-3M.0-I.4 23МУ4	ЗДАНИЕ 4Т 4.6.30-зал(12)40-4.0	80
I.220.I-3M.0-I.4 24МУ1	ЗДАНИЕ ЗТ 4.7.30-зал(12)40-2.5	82
I.220.I-3M.0-I.4 24МУ2	ЗДАНИЕ ЗТ 4.7.30-зал(12)40-4.0	83
I.220.I-3M.0-I.4 24МУ3	ЗДАНИЕ 4Т 4.7.30-зал(12)40-2.5	85
I.220.I-3M.0-I.4 24МУ4	ЗДАНИЕ 4Т 4.7.30-зал(12)40-4.0	87
I.220.I-3M.0-I.4 25	ЗДАНИЕ ЗТ 4.5-зал(24) 4Т 4.5-зал(24)	89
I.220.I-3M.0-I.4 25СБ	ЗДАНИЕ ЗТ 4.5-зал(24) 4Т 4.5-зал(24)	91
I.220.I-3M.0-I.4 25МУ1	ЗДАНИЕ ЗТ 4.5.30-зал(24)40-2.5	94
I.220.I-3M.0-I.4 25МУ2	ЗДАНИЕ ЗТ 4.5.30-зал(24)40-4.0	95
I.220.I-3M.0-I.4 25МУ3	ЗДАНИЕ 4Т 4.5.30-зал(24)32-3.5	97
I.220.I-3M.0-I.4 25МУ4	ЗДАНИЕ 4Т 4.5.30-зал(24)40-4.0	99
I.220.I-3M.0-I.4 26	ЗДАНИЕ ЗТ 6.5-зал(2x12) 4Т 6.5-зал(2x12)	101
I.220.I-3M.0-I.4 26СБ	ЗДАНИЕ ЗТ 6.5-зал(2x12) 4Т 6.5-зал(2x12)	103
I.220.I-3M.0-I.4 26МУ1	ЗДАНИЕ ЗТ 6.5.30-зал(2x12)40-4.0	106
I.220.I-3M.0-I.4 26МУ2	ЗДАНИЕ 4Т 6.5.30-зал(2x12)40-4.0	107
I.220.I-3M.0-I.4 27	ЗДАНИЕ ЗТ 4.7-зал(24) 4Т 4.7-зал(24)	110
I.220.I-3M.0-I.4 27СБ	ЗДАНИЕ ЗТ 4.7-зал(24) 4Т 4.7-зал(24)	112
I.220.I-3M.0-I.4 27МУ1	ЗДАНИЕ ЗТ 4.7.30-зал(24)32-3.5	118
I.220.I-3M.0-I.4 27МУ2	ЗДАНИЕ ЗТ 4.7.30-зал(24)40-2.5	119
I.220.I-3M.0-I.4 27МУ3	ЗДАНИЕ 4Т 4.7.30-зал(24)32-3.5	121
I.220.I-3M.0-I.4 27МУ4	ЗДАНИЕ 4Т 4.7.30-зал(24)40-4.0	123
I.220.I-3M.0-I.4 28	ЗДАНИЕ ЗТ 6.7-зал(2x12) 4Т 6.7-зал(2x12)	125
I.220.I-3M.0-I.4 28СБ	ЗДАНИЕ ЗТ 6.7-зал(2x12) 4Т 6.7-зал(2x12)	128
I.220.I-3M.0-I.4 28МУ1	ЗДАНИЕ ЗТ 6.7.30-зал(2x12)40-2.5	134
	I.220.I-3M.0-I.4 00	
ПОДЛ. И ДАТА		ЛИСТ
ИВЕН ПОДЛ		2

23171-04 3
ФОРМАТ А 4

ОБОЗНАЧЕНИЕ	НАИМЕНОВАНИЕ	СТР.
I.220.I-3M.0-I.4 28MU2	ЗДАНИЕ 3Т 6.7.30-зал(2xI2)40-4.0	135
I.220.I-3M.0-I.4 28MU3	ЗДАНИЕ 4Т 6.7.30-зал(2xI2)40-2.5	137
I.220.I-3M.0-I.4 28MU4	ЗДАНИЕ 4Т 6.7.30-зал(2xI2)40-4.0	139
I.220.I-3M.0-I.4 28MU5	ЗДАНИЕ 4Т 6.7.30-зал(2xI2)32-3.5	141
I.220.I-3M.0-I.4 29	ЗДАНИЕ 3С 5.5-зал(2xI2)	143
I.220.I-3M.0-I.4 29СБ	ЗДАНИЕ 3С 5.5-зал(2xI2)	144
I.220.I-3M.0-I.4 29МУ	ЗДАНИЕ 3С 5.5.30-зал(2xI2)32-3.5	147

I.220.I-3M.0-I.4 00	3
---------------------	---

ФОРМАТ А4

ФУРГОРЫ 9/1982	ОПЕРАТОР СИСТЕМ	I. ОБЩАЯ ЧАСТЬ																			
		Выпуск 0-I часть 4 серии I.220.I-3M содержит для трех- и четырех-этажных зданий с техническим подпольем и с зальными помещениями на верхних этажах: рабочие чертежи монтажных планов ростверков, колонн, ригелей и связевых плит; спецификации к монтажным планам; таблицы максимальных усилий по группам элементов.																			
САПР КиевЗНИИЭП	ВЗАМ. ИВБ ИМ	2. МОНТАЖНЫЕ ПЛАНЫ ЭЛЕМЕНТОВ																			
		<p>На монтажных планах показаны условные марки элементов. На первом листе дана таблица исполнений. Расшифровку схем зданий и разрезы к ним см. выпуск 0-I часть I документ 03 листы 1...6.</p> <p>Монтажные планы ригелей и связевых плит даны на отметках -2.32, -1.10, +3.20, +6.50, +9.80. Конструктивное описание технического подполья над холодным подпольем см. выпуск 0-I часть I.</p> <p>На монтажных планах колонн, ригелей и связевых плит прямоугольником показаны незамаркированные диафрагмы жесткости. Рабочие чертежи диафрагм жесткости см. выпуск 4-I; расположение по высоте здания см. выпуск 0-IчI документ 09.</p> <p>Металлические конструкции покрытия (обозначенные условной маркой Б) разрабатываются при конкретном проектировании (см. выпуск 0-IчI документ 16); также монолитные ростверки (см. вып. 0-1ч. I докум. 09).</p> <p>Отметки в скобках на монтажных планах ригелей и связевых плит даны для четырехэтажных зданий.</p> <p>Условные обозначения марок: Ф - ростверк, Р - ригель, Б - металлическая конструкция. К - колонна, ПИ - связевая плита.</p>																			
ПОДПИСЬ И ДАТА	ИВБ ИМ	3. ТАБЛИЦА МАКСИМАЛЬНЫХ УСИЛИЙ																			
		<p>В таблицах максимальных усилий приведены усилия по группам элементов от отдельных нагрузок. Номера нагрузок, группы элементов и виды знаков для усилий M, Mx, My, Qx, Qy, и их размерность см. выпуск 0-I часть I документ 03 лист 6.</p> <p>Каждому сборочному чертежу соответствует несколько таблиц максимальных усилий. Таблицы даны для всех зданий, указанных в таблице исполнений. На первом листе таблицы максимальных усилий дано полное наименование шифра здания. В обозначении документа на первом и последующих листах к номеру документа добавлены символы МУ (максимальные усилия).</p>																			
ПОДПИСЬ И ДАТА	ИВБ ИМ	I.220.I-3M.0-I.4 00Т0																			
		<table border="1"> <tr> <td>НАЧЛОТД</td> <td></td> <td></td> <td></td> </tr> <tr> <td>И.КОНТР.</td> <td></td> <td></td> <td></td> </tr> <tr> <td>П.СПЕЦ.</td> <td></td> <td></td> <td></td> </tr> <tr> <td>ПРОВЕРИЛ</td> <td>Гуданов</td> <td></td> <td></td> </tr> <tr> <td>РАЗРАБ</td> <td>Бойко</td> <td></td> <td></td> </tr> </table>		НАЧЛОТД				И.КОНТР.				П.СПЕЦ.				ПРОВЕРИЛ	Гуданов			РАЗРАБ	Бойко
НАЧЛОТД																					
И.КОНТР.																					
П.СПЕЦ.																					
ПРОВЕРИЛ	Гуданов																				
РАЗРАБ	Бойко																				
ИВБ ИМ	ПОДПИСЬ И ДАТА	ТЕХНИЧЕСКОЕ ОПИСАНИЕ	<table border="1"> <tr> <td>СТАДИЯ</td> <td>ЛИСТ</td> <td>ЛИСТОВ</td> </tr> <tr> <td>Р</td> <td>1</td> <td>1</td> </tr> </table> <p>ГОСГРАЖДАНСТРОЙ КиевЗНИИЭП</p>	СТАДИЯ	ЛИСТ	ЛИСТОВ	Р	1	1												
СТАДИЯ	ЛИСТ	ЛИСТОВ																			
Р	1	1																			

23171-04 4

ФОРМАТ А4

МАРКА ПОЗ	ОБОЗНАЧЕНИЕ	НАИМЕНОВАНИЕ	КОП	МАССА ЕД КГ	ПРИМЕЧАНИЕ
К5	I.220.I-3M.2-I II-05	КДЗТ 3.33-40.2	2	244I	
К6	I.220.I-3M.2-I II-06	КДЗТ 3.33-40.7	2	2532	
К7	I.220.I-3M.2-I 09-0I	КДТ 3.33-25.2	3	786	
К8	I.220.I-2M.2-I I5-06	КДЗТ 3.33-25.2	I	2396	
К9	I.220.I-3M.2-I II	КДЗТ 3.33-25.2	I	244I	
К10	I.220.I-3M.2-I I7	КОЗТ 3.33-25.2	2	2320	
К11	I.220.I-3M.2-I I3	КОЗТ 3.33-25.2	2	2373	
К12	I.220.I-3M.2-I I3	КОЗТ 3.33-25.2	2	2373	
К13	I.220.I-3M.2-I I7-02	КОЗТ 3.33-40.7 РИГЕЛЬ	2	2414	
Р3	I.020-I/83.3-I 07-02	РОП 4.57-40	8	2070	
Р4	I.020-I/83.3-I 02-03	РДП 4.57-70АТУ	8	2600	
Р7	I.020-I/83.3-I I0-0I	РОП 4.69-40	4	2520	
Р8	I.020-I/83.3-I 04-03	РДП 4.69-70АТУ СВЯЗЕВАЯ ПЛИТА	6	3170	
Р11	I.04I.I-2.I.200-0I	ПК56.I2-8АТУС(А1У)Т-I	12	2000	
Р12	I.04I.I-2.I.400-02	ПК56.I5-8АТУС(А1У)Т-2 I.220.I-3M.0-I.4 I9-02 4Т 4.4.30-ЗАЛ(I2) 40-2.5	16	2600	
		РОСТВЕРК			
Ф1	I.220.I-3M.I-I 04-0I	Ф3-40	4	3625	
Ф2	I.220.I-3M.I-I 03-0I	ИФ3-40	8	3755	
Ф3	I.220.I-3M.I-I 02-0I	Ф2-40	3	2575	
Ф4	I.220.I-3M.I-I 05-0I	Ф4-40	2	4100	
Ф6		ФД9-40	2		
Ф12		ИФД11-40	2		
		КОЛОННА			
К1	I.220.I-3M.2-I I8	КО4Т 3.33-40.2	4	3179	
К2	I.220.I-3M.2-I 24-03	КОФ4Т 3.33-40.7	I	3248	
К3	I.220.I-3M.2-I I8-05	КД4Т 3.33-40.3	2	3343	
К4	I.220.I-3M.2-I I8-0I	КО4Т 3.33-40.2	I	3179	
К5	I.220.I-3M.2-I I8-05	КД4Т 3.33-40.3	2	3343	
К6	I.220.I-3M.2-I I8-07	КД4Т 3.33-40.7	2	3392	
I.220.I-3M.0-I.4 I9					ЛИСТ 3

ФОРМАТ А4

МАРКА ПОЗ	ОБОЗНАЧЕНИЕ	НАИМЕНОВАНИЕ	КОП	МАССА ЕД КГ	ПРИМЕЧАНИЕ
К7	I.220.I-3M.2-I I0-0I	КД2Т 3.33-25.2	3	I613	
К8	I.220.I-3M.2-I 27-0I	КДФ4Т 3.33-40.2	I	3224	
К9	I.220.I-3M.2-I I8-04	КД4Т 3.33-40.2	I	3269	
К10	I.220.I-3M.2-I 24	КОФ4Т 3.33-30.2	2	3125	
К11	I.220.I-3M.2-I I8	КО4Т 3.33-30.2	2	3179	
К12	I.220.I-3M.2-I I8-0I	КО4Т 3.33-40.2	2	3179	
К13	I.220.I-3M.2-I 24-03	КОФ4Т 3.33-40.7 РИГЕЛЬ	2	3248	
Р3	I.020-I/83.3-I 07-02	РОП 4.57-40	14	2070	
Р4	I.020-I/83.3-I 02-03	РДП 4.57-70АТУ	15	2600	
Р7	I.020-I/83.3-I I0-0I	РОП 4.69-40	6	2520	
Р8	I.020-I/83.3-I 04-03	РДП 4.69-70АТУ СВЯЗЕВАЯ ПЛИТА	9	3170	
Р11	I.04I.I-2.I.200-0I	ПК56.I2-8АТУС(А1У)Т-I	18	2000	
Р12	I.04I.I-2.I.400-02	ПК56.I5-8АТУС(А1У)Т-2 I.220.I-3M.0-I.4 I9-03 4Т 4.4.30-ЗАЛ(I2) 40-4.0	28	2600	
		РОСТВЕРК			
Ф1	I.220.I-3M.I-I 04-0I	Ф3-40	4	3625	
Ф2	I.220.I-3M.I-I 03-0I	ИФ3-40	8	3755	
Ф3	I.220.I-3M.I-I 02-0I	Ф2-40	3	2575	
Ф4	I.220.I-3M.I-I 05-0I	Ф4-40	2	4100	
Ф6		ФД9-40	2		
Ф12		ИФД11-40	2		
		КОЛОННА			
К1	I.220.I-3M.2-I I8	КО4Т 3.33-30.2	4	3179	
К2	I.220.I-3M.2-I 24-03	КОФ4Т 3.33-40.7	I	3248	
К3	I.220.I-3M.2-I I8-04	КД4Т 3.33-40.2	2	3269	
К4	I.220.I-3M.2-I I8-04	КО4Т 3.33-40.2	I	3269	
К5	I.220.I-3M.2-I I8-04	КД4Т 3.33-40.2	2	3269	
К6	I.220.I-3M.2-I I8-07	КД4Т 3.33-40.7	2	3392	
К7	I.220.I-3M.2-I I0-0I	КД2Т 3.33-25.2	3	I613	
К8	I.220.I-3M.2-I 27-0I	КДФ4Т 3.33-40.2	I	3224	
I.220.I-3M.0-I.4 I9					ЛИСТ 4

23171-04 6

ФОРМАТ А4

МАРКА ПОЗ.	ОБОЗНАЧЕНИЕ	НАИМЕНОВАНИЕ	КОП.	МАССА ЕД. КГ.	ПРИМЕЧАНИЕ
Р02	I.04I.I-2.I.400-02	ПК56.15-BAIYС(AIY)T-2 I.220.I-3M.0-I.4 20-01 3T 4.4.30-3AI(24) 40-4.0 РОСТВЕРК	12	2600	
Ф1	I.220.I-3M.I-I 04-01	2Ф3-40	4	3625	
Ф2	I.220.I-3M.I-I 03-01	1Ф3-40	4	3755	
Ф4	I.220.I-3M.I-I 02-01	Ф2-40	9	2575	
Ф6		ФД9-40	4		
К1	I.220.I-3M.2-I 13-03	КОЛОННА			
К2	I.220.I-3M.2-I 17-02	КОЭТ 3.33-30.2	4	2373	
К3	I.220.I-3M.2-I 11-06	КОЭТ 3.33-40.7	2	2414	
К4	I.220.I-3M.2-I 17-02	КДЭТ 3.33-40.7	2	2532	
К5	I.220.I-3M.2-I 15-08	КОЭТ 3.33-40.7	4	2414	
К6	I.220.I-3M.2-I 09-01	КДЭТ 3.33-40.7 КДМЭТ 3.33-40.7 КДТ 3.33-25.2	4 4 9	2509 786	
Р3	I.020-I/83.3-I 07-02	РИГЕЛЬ	6	2070	
Р4	I.020-I/83.3-I 02-03	РОП 4.57-40 РДП 4.57-70ATY	12	2600	
РП	I.04I.I-2.I.200-01	СВЯЗЕВАЯ ПЛИТА			
РП2	I.04I.I-2.I.400-02	ПК56.12-BAIYС(AIY)T-I ПК56.15-BAIYС(AIY)T-2 I.220.I-3M.0-I.4 20-03 4T 4.4.30-3AI(24) 40-2.5 РОСТВЕРК	6 12	2000 2600	
Ф1	I.220.I-3M.I-I 04-01	2Ф3-40	4	3625	
Ф2	I.220.I-3M.I-I 03-01	1Ф3-40	4	3755	
Ф4	I.220.I-3M.I-I 02-01	Ф2-40	9	2575	
Ф6		ФД9-40	4		
К1	I.220.I-3M.2-I 16	КОЛОННА			
К1	I.220.I-3M.2-I 16	КОЭТ 3.33-30.2	4	3179	
I.220.I-3M.0-I.4 20					ЛИСТ 2

ФОРМАТ А.4

МАРКА ПОЗ.	ОБОЗНАЧЕНИЕ	НАИМЕНОВАНИЕ	КОП.	МАССА ЕД. КГ.	ПРИМЕЧАНИЕ
К2	I.220.I-3M.2-I 24-03	КОЭТ 3.33-40.7	2	3248	
К3	I.220.I-3M.2-I 18-07	КДЭТ 3.33-40.7	2	3392	
К4	I.220.I-3M.2-I 24-03	КОЭТ 3.33-40.7	4	3248	
К5	I.220.I-3M.2-I 21-06	КДМЭТ 3.33-40.7	4	3346	
К6	I.220.I-3M.2-I 10-01	КДТ 3.33-25.2	9	1613	
Р3	I.020-I/83.3-I 07-02	РИГЕЛЬ			
Р4	I.020-I/83.3-I 02-03	РОП 4.57-40 РДП 4.57-70ATY	12 24	2070 2600	
РП	I.04I.I-2.I.200-01	СВЯЗЕВАЯ ПЛИТА			
РП2	I.04I.I-2.I.400-02	ПК56.12-BAIYС(AIY)T-I ПК56.15-BAIYС(AIY)T-2 I.220.I-3M.0-I.4 20-03 4T 4.4.30-3AI(24) 40-4.0 РОСТВЕРК	12 24	2000 2600	
Ф1	I.220.I-3M.I-I 04-01	2Ф3-40	4	3625	
Ф2	I.220.I-3M.I-I 03-01	1Ф3-40	4	3755	
Ф4	I.220.I-3M.I-I 02-01	Ф2-40	9	2575	
Ф6		ФД9-40	4		
К1	I.220.I-3M.2-I 18	КОЛОННА			
К2	I.220.I-3M.2-I 24-03	КОЭТ 3.33-30.2	4	3179	
К3	I.220.I-3M.2-I 18-07	КОЭТ 3.33-40.7	2	3248	
К4	I.220.I-3M.2-I 24-03	КДЭТ 3.33-40.7	2	3392	
К5	I.220.I-3M.2-I 21-06	КОЭТ 3.33-40.7	4	3248	
К6	I.220.I-3M.2-I 10-01	КДМЭТ 3.33-40.7 КДТ 3.33-25.2	4 9	3346 1613	
Р3	I.020-I/83.3-I 07-02	РИГЕЛЬ			
Р4	I.020-I/83.3-I 02-03	РОП 4.57-40 РДП 4.57-70ATY	12 24	2070 2600	
РП	I.04I.I-2.I.200-01	СВЯЗЕВАЯ ПЛИТА			
РП2	I.04I.I-2.I.400-02	ПК56.12-BAIYС(AIY)T-I ПК56.15-BAIYС(AIY)T-2	12 24	2000 2600	
I.220.I-3M.0-I.4 20					ЛИСТ 3

23171-04 8

ФОРМАТ А.4

МОНТАЖНЫЙ ПЛАН РОСТВЕРКОВ

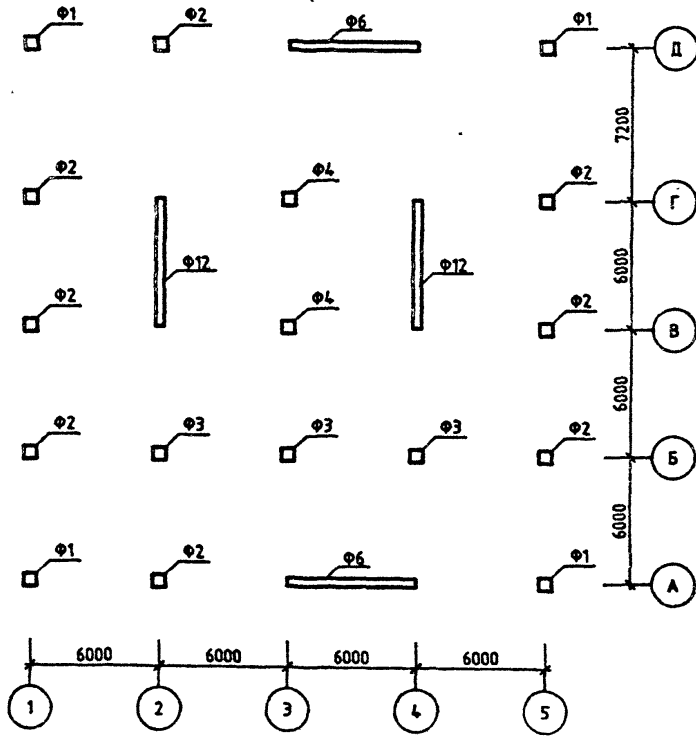

ОБОЗНАЧЕНИЕ	ШИФР ЗДАНИЯ
1.220.1-3М.0-1.4 19	ЭТ 4.4.30-ЗАЛ(12)40-25
-01	ЭТ 4.4.30-ЗАЛ(12)40-4.0
-02	ЛТ 4.4.30-ЗАЛ(12)40-25
-03	ЛТ 4.4.30-ЗАЛ(12)40-4.0

МОНТАЖНЫЙ ПЛАН КОЛОНН

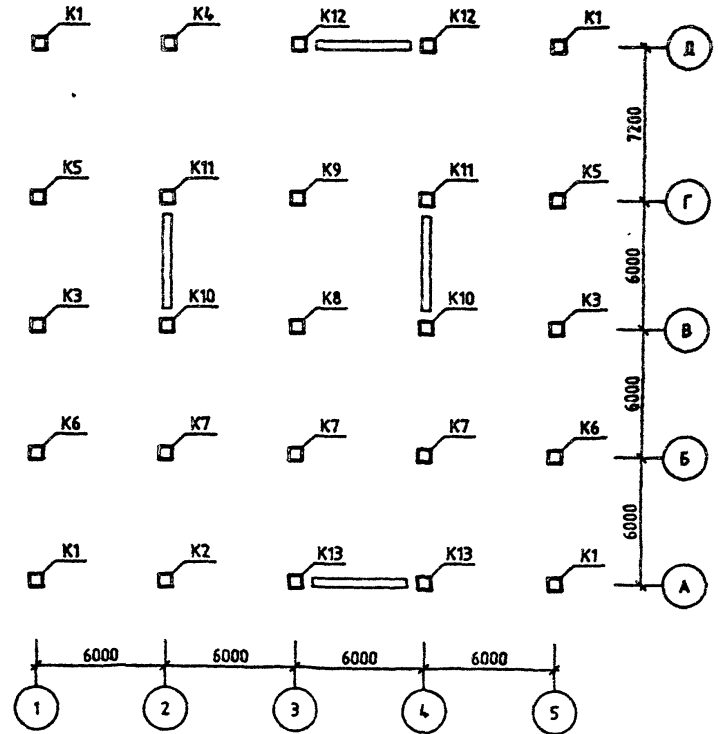

				1.220.1-3М.0-1.4 190Б		
				ЗДАНИЕ		
				ЭТ 4.4-ЗАЛ(12)		
				ЛТ 4.4-ЗАЛ(12)		
Нач. отд.	Шевченко			СТАДИЯ	ЛИСТ	ЛИСТОВ
ГИП	Егузов			Р	1	3
И.КОНТР.	Эуежко			ГОСГРАЖДАНСТРОЯ		
ПРОВЕРИЛ	Бойко			КиевЗНИИЭП		
РАЗРАБ	Рудашкин					

МОНТАЖНЫЙ ПЛАН РИГЕЛЕЙ И СВЯЗЕВЫХ ПЛИТ

ОТМ. -2.32

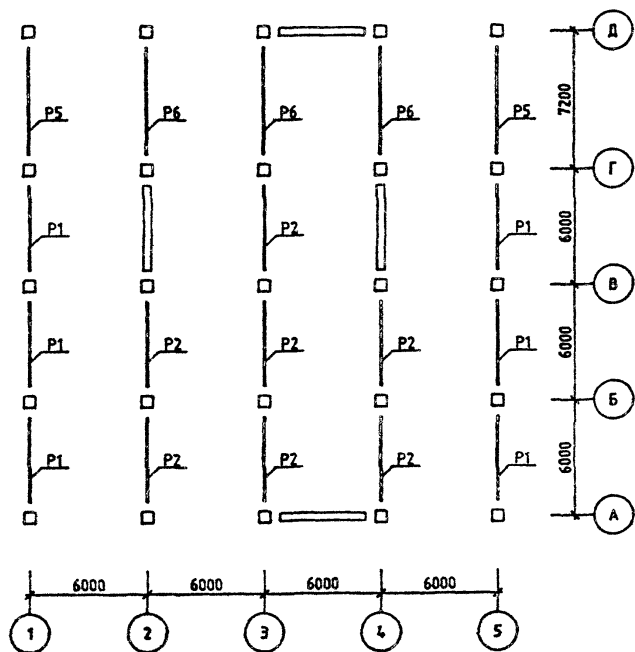

МОНТАЖНЫЙ ПЛАН РИГЕЛЕЙ И СВЯЗЕВЫХ ПЛИТ

ОТМ. -0.10 (+3.20)

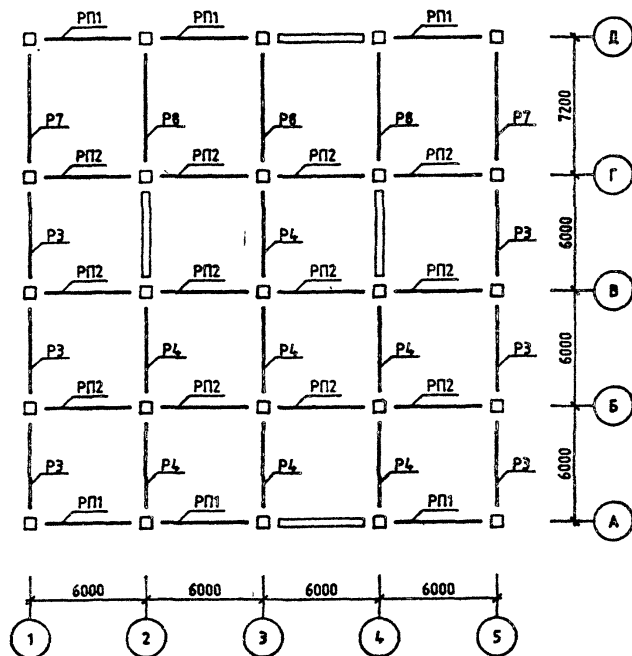

1.220.1-3М.0-1.4 1906

ЛИСТ

2

23171-04 10

ФОРМАТ А3

МОНТАЖНЫЙ ПЛАН РИГЕЛЕЙ И СВЯЗЕВЫХ ПЛИТ

ОТМ. +3.20 (+6.50)

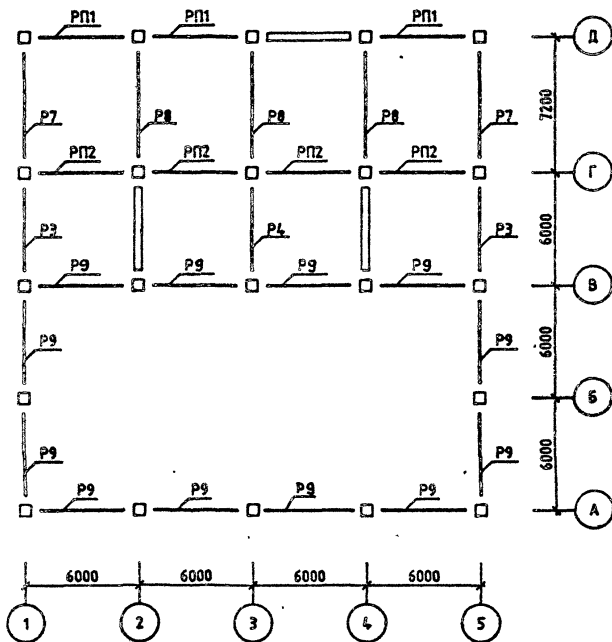

МОНТАЖНЫЙ ПЛАН РИГЕЛЕЙ И СВЯЗЕВЫХ ПЛИТ

ОТМ. +6.50 (+9.80)

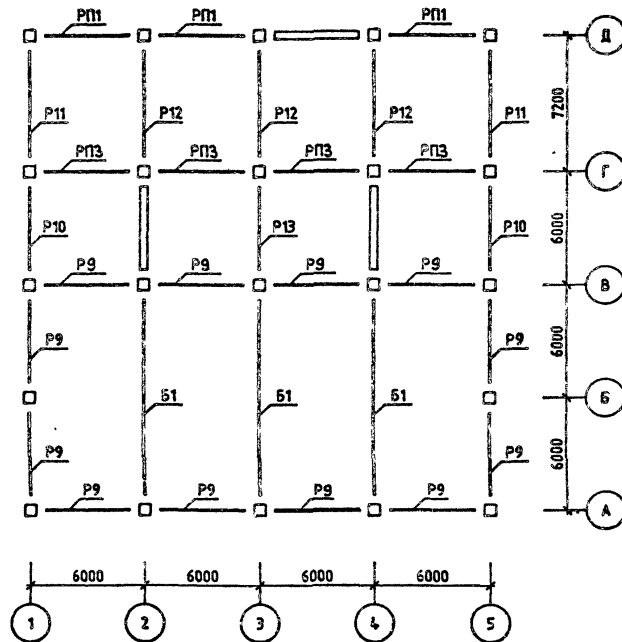

1.220.1-3М.0-1.4 19С6

ЛИСТ

3

23171-04 11

ФОРМАТ А3

МОНТАЖНЫЙ ПЛАН РОСТВЕРКОВ

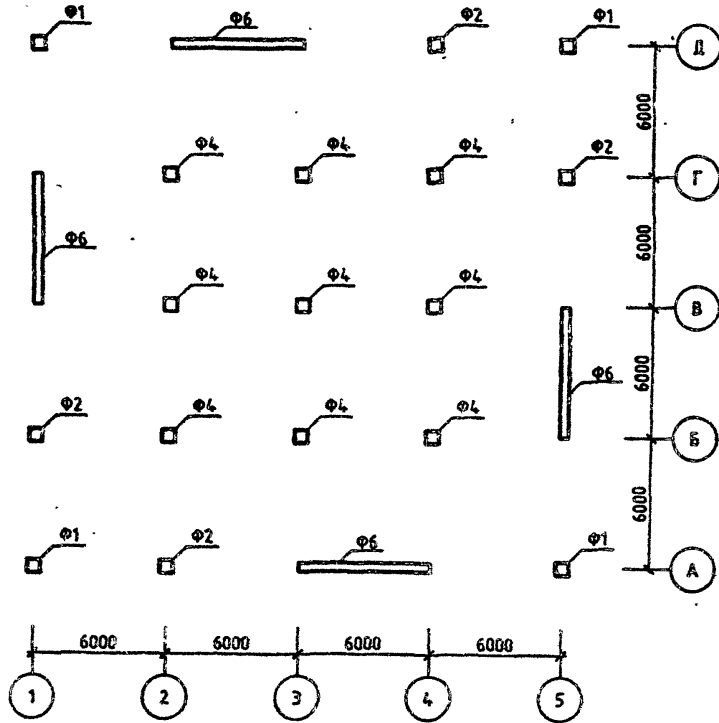

МОНТАЖНЫЙ ПЛАН КОЛОНН

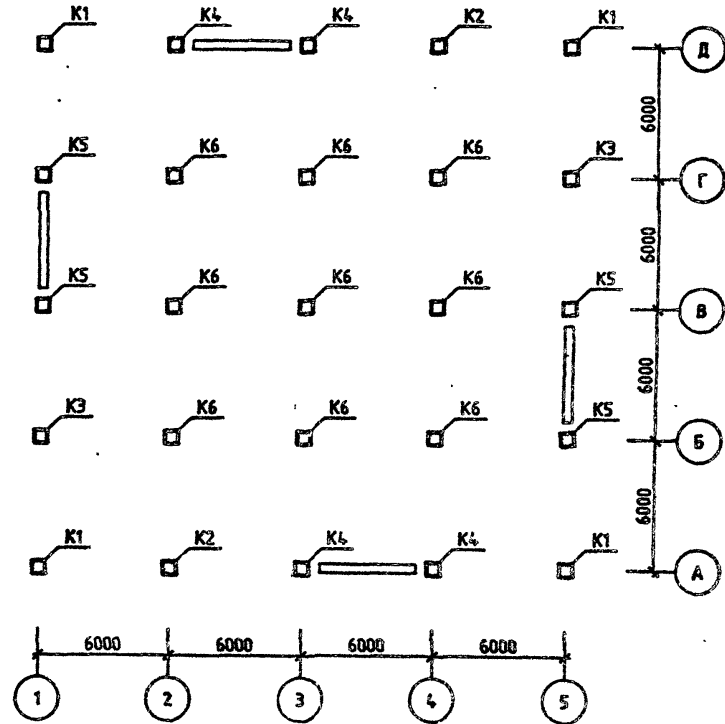

ОБОЗНАЧЕНИЕ	ШИФР ЗДАНИЯ
1.220.1-3М.0-1.4 20	ЭТ 4.4.30-ЗАЛ(24)40-2.5
-01	ЭТ 4.4.30-ЗАЛ(24)40-4.0
-02	4Т 4.4.30-ЗАЛ(24)40-2.5
-03	4Т 4.4.30-ЗАЛ(24)40-4.0

1.220.1-3М.0-1.4 20СБ			
Исх. отд.	Шевченко	ЭТАЖ	ЗДАНИЕ ЭТ 4.4-ЗАЛ(24) 4Т 4.4-ЗАЛ(24)
ГИП	Егущев		
И.КОНТР.	Зуевко	СТАДИЯ	ЛИСТ
ПРОВЕРИЛ	Бойко		
РАЗРАБ	Рудавин	ЛИСТОВ	
			3
ГОСГРАЖДАНСТРОЙ			
КиевЗНИИЭП			

МОНТАЖНЫЙ ПЛАН РИГЕЛЕЙ И СВЯЗЕВЫХ ПЛИТ

ОТМ. -2.32

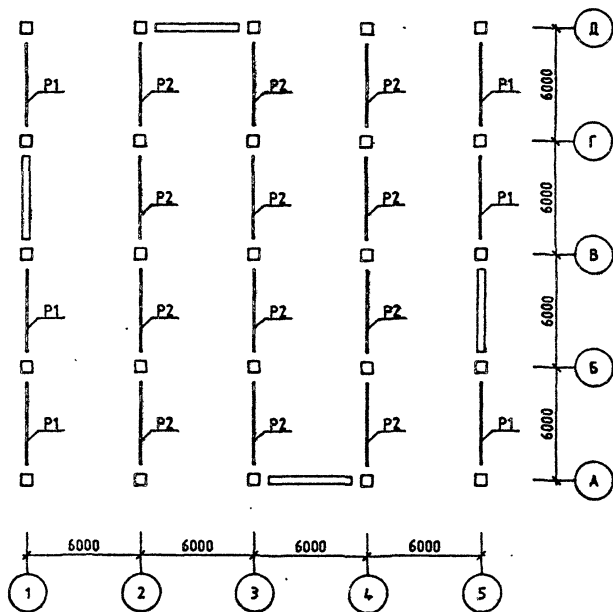

МОНТАЖНЫЙ ПЛАН РИГЕЛЕЙ И СВЯЗЕВЫХ ПЛИТ

ОТМ. -0.10 (+3.20)

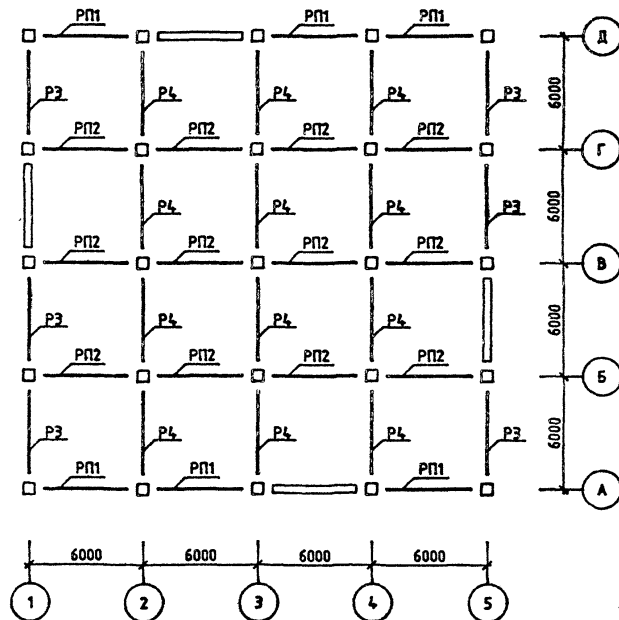

МОНТАЖНЫЙ ПЛАН РИГЕЛЕЙ

ОТМ. +3.20 (+6.50)

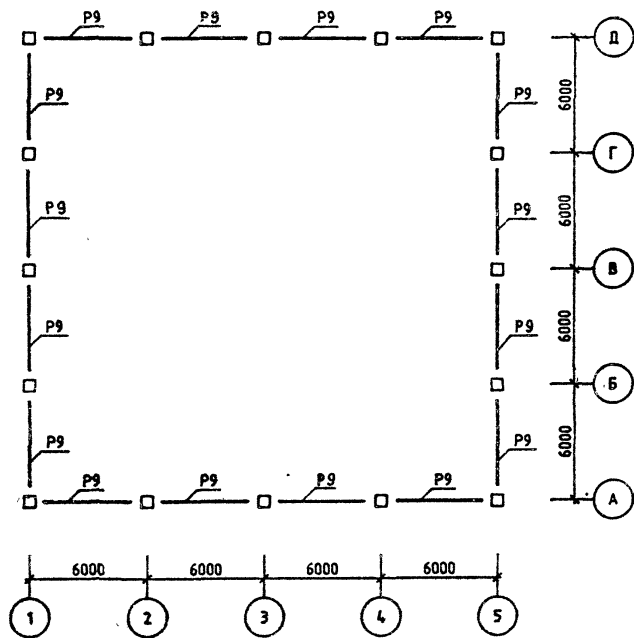

МОНТАЖНЫЙ ПЛАН РИГЕЛЕЙ

ОТМ. +6.50 (+9.80)

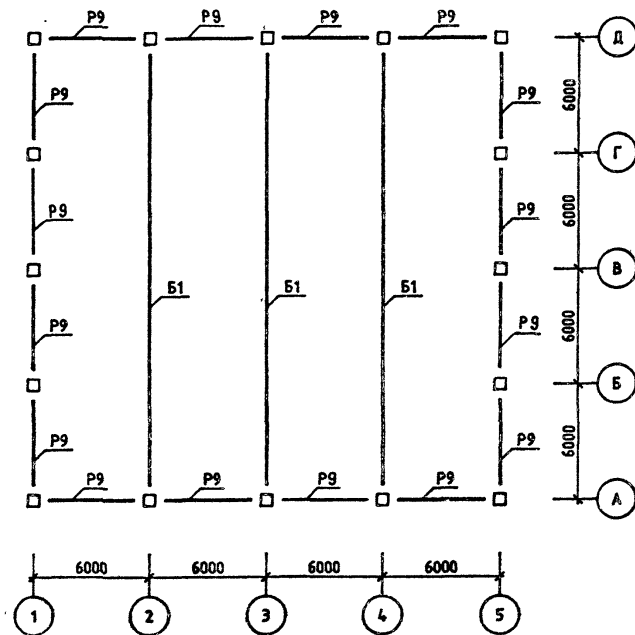

1.220.1-3М.0-1.4 2006

ЛИСТ

3

23171-04 14
ФОРМАТ А3

Номер загрузки	Тип усилия	Номер группы элементов								
		1	2	3	4	5	6	7	8	
ЯРУС 1 СЕЧЕНИЕ 1										
1	N	0.0	0.0	0.0	0.0	-7.4	-4.8	0.0	0.0	
	MX	-7.1	-6.7	8.2	3.7	35.6	-12.4	-4.7	-10.2	
	QU	2.0	1.8	-2.2	-1.0	-27.6	2.9	1.0	2.5	
	MU	6.8	10.8	6.2	2.3	13.9	-18.2	4.5	6.3	
	QX	-1.5	-1.7	1.6	0.5	-2.3	14.4	0.3	1.6	
8	N	0.0	0.0	0.0	0.0	-2.1	-19.8	0.0	0.0	
	MX	-0.2	-0.3	0.0	0.0	-0.2	-0.1	0.0	0.1	
	QU	0.1	0.1	0.0	0.0	0.2	0.0	0.0	0.0	
	MU	1.3	2.1	1.5	1.6	2.9	-9.2	-1.1	1.3	
	QX	0.7	1.0	0.8	0.9	3.3	-6.3	-0.2	0.7	
9	N	0.0	0.0	0.0	0.0	-16.5	0.0	0.0	0.0	
	MX	0.3	0.5	0.5	0.7	6.2	0.6	0.4	-0.3	
	QU	-0.1	-0.1	-0.1	-0.2	-5.0	-0.1	-0.1	0.2	
	MU	0.0	0.0	0.0	0.0	0.0	0.0	0.0	0.0	
	QX	0.0	0.0	0.0	0.0	0.0	0.0	0.0	0.0	
14	N	104.6	138.8	137.4	175.5	137.0	123.9	82.4	117.4	
	MX	-0.5	0.4	0.6	0.7	4.7	-1.8	0.1	-2.4	
	QU	0.5	-0.2	-1.4	-0.2	-5.1	1.8	0.0	1.8	
	MU	-0.7	1.0	0.2	0.0	0.2	-0.2	0.0	0.2	
	QX	-0.8	-1.4	0.1	0.0	0.0	0.0	0.0	0.0	
ЯРУС 1 СЕЧЕНИЕ 2										
1	N	0.0	0.0	0.0	0.0	7.4	4.8	0.0	0.0	
	MX	2.0	2.2	-2.7	-1.3	33.3	5.1	2.3	3.8	
	QU	-2.0	-1.8	2.2	1.0	27.6	-2.9	-1.0	-2.5	
	MU	-2.0	-3.8	-2.2	-1.0	-4.6	-17.0	-2.2	-2.2	
	QX	1.5	1.7	-1.6	-0.5	2.3	-14.4	-0.3	-1.6	
8	N	0.0	0.0	0.0	0.0	2.1	19.8	0.0	0.0	
	MX	0.0	0.1	0.0	0.0	-0.3	0.0	0.0	0.0	
	QU	0.0	-0.1	0.0	0.0	-0.2	0.0	0.0	0.0	
	MU	0.7	0.6	0.6	0.5	5.5	-8.5	0.6	0.5	
	QX	-0.8	-1.0	-0.8	-0.9	-3.3	7.0	0.2	-0.7	
9	N	0.0	0.0	0.0	0.0	16.5	0.0	0.0	0.0	
	MX	-0.1	-0.2	-0.2	-0.3	6.3	-0.6	-0.2	-0.2	
	QU	0.1	0.1	0.1	0.2	5.0	-0.1	0.1	-0.2	
	MU	0.0	0.0	0.0	0.0	0.0	0.0	0.0	0.0	
	QX	0.0	0.0	0.0	0.0	0.0	0.0	0.0	0.0	
14	N	-104.6	-138.8	-137.4	-175.5	-137.0	-123.9	-82.4	-117.4	
	MX	1.3	-0.5	3.0	-1.0	8.1	-2.7	0.0	-2.1	
	QU	0.7	-0.3	1.4	-0.4	5.1	-1.8	0.0	-1.8	
	MU	1.7	-2.9	0.0	0.0	0.0	-0.2	0.0	0.0	
	QX	-0.9	1.5	-0.1	0.0	0.0	0.0	0.0	0.0	
1.220.1-3М.0-1.4 19МУ1										
ГИП	Егунов				СТАДИЯ	ЛМСТ	ЛИСТОВ			
И КОНТР	Бойко				Р	1	3			
РУК. ГР.	Рудавик				ЗДАНИЕ					
ПРОВЕРИЛ	Футорная				3Т 4.4.30-ЗАЛ(12)40-2.5					
РАЗРАБ	Зуенко				ГОСГРАЖДАНСТРОЙ					
					КиевЗНИИЭП					

ФОРМАТ А4

Номер загрузки	Тип усилия	Номер группы элементов								
		1	2	3	4	5	6	7	8	
ЯРУС 2 СЕЧЕНИЕ 1										
1	N	0.0	0.0	0.0	0.0	-9.1	-5.0	0.0	0.0	
	MX	-2.0	-2.2	2.7	1.3	-0.4	-1.8	-2.3	-3.8	
	QU	2.0	1.8	-2.2	-1.0	0.2	1.3	1.0	2.5	
	MU	2.0	3.8	2.2	1.0	1.9	-0.4	2.2	2.2	
	QX	-1.5	-1.7	1.6	0.5	1.6	-0.3	0.3	1.6	
8	N	0.0	0.0	0.0	0.0	1.1	-6.4	0.0	0.0	
	MX	0.0	-0.1	0.0	0.0	-0.1	0.0	0.0	0.0	
	QU	0.0	0.1	0.0	0.0	0.0	0.0	0.0	0.0	
	MU	-0.7	-0.6	-0.6	-0.5	0.6	0.4	-0.6	-0.5	
	QX	0.8	1.0	0.8	0.9	1.7	0.3	-0.2	0.7	
9	N	0.0	0.0	0.0	0.0	5.2	0.0	0.0	0.0	
	MX	-0.1	-0.2	0.2	0.3	0.2	0.1	0.2	0.2	
	QU	-0.1	-0.1	-0.1	-0.2	-0.1	-0.1	-0.1	0.2	
	MU	0.0	0.0	0.0	0.0	0.0	0.0	0.0	0.0	
	QX	0.0	0.0	0.0	0.0	0.0	0.0	0.0	0.0	
14	N	74.3	102.2	101.5	134.0	56.0	67.9	44.1	84.7	
	MX	0.9	-0.3	1.7	-0.4	0.3	0.9	0.0	-1.1	
	QU	-0.7	0.3	-1.4	0.4	-0.1	-0.7	0.0	1.8	
	MU	-1.1	1.6	0.0	0.0	0.0	-0.2	0.0	0.0	
	QX	-0.9	1.5	0.1	0.0	0.0	-0.5	0.0	0.0	
ЯРУС 2 СЕЧЕНИЕ 2										
1	N	0.0	0.0	0.0	0.0	9.1	5.0	0.0	0.0	
	MX	-2.9	-2.1	2.6	1.0	-0.2	-1.4	0.0	-2.3	
	QU	-2.0	-1.8	2.2	1.0	-0.2	-1.3	-1.0	-2.5	
	MU	2.5	3.1	1.6	0.3	1.9	-0.3	0.0	1.6	
	QX	1.5	1.7	-1.6	-0.5	-1.6	0.3	-0.3	-1.6	
8	N	0.0	0.0	0.0	0.0	-1.1	6.4	0.0	0.0	
	MX	-0.2	-0.2	0.0	0.0	0.0	0.0	0.0	0.0	
	QU	-0.1	-0.1	0.0	0.0	0.0	0.0	0.0	0.0	
	MU	2.6	3.1	2.6	2.5	3.5	0.5	0.0	2.2	
	QX	-0.7	-1.0	-0.8	-0.9	-1.7	-0.3	0.2	-0.7	
9	N	0.0	0.0	0.0	0.0	-5.2	0.0	0.0	0.0	
	MX	0.1	0.1	0.1	0.2	0.1	-0.2	0.0	-0.7	
	QU	0.1	0.1	0.1	0.2	0.1	-0.1	0.1	-0.2	
	MU	0.0	0.0	0.0	0.0	0.0	0.0	0.0	0.0	
	QX	0.0	0.0	0.0	0.0	0.0	0.0	0.0	0.0	
14	N	-74.3	-102.2	-101.5	-134.0	-56.0	-67.9	-44.1	-84.7	
	MX	-0.8	0.4	1.7	-0.5	-0.2	-1.2	0.0	-3.2	
	QU	-0.5	0.2	1.4	-0.4	0.0	-0.8	0.0	-1.8	
	MU	-1.1	2.0	0.1	0.0	0.0	-1.0	0.0	0.1	
	QX	0.8	1.4	-0.1	0.0	0.0	-0.5	0.0	0.0	
1.220.1-3М.0-1.4 19МУ1										
ИНВ. ПОДЛ	ПОДПИСЬ И ДАТА	ВЗАМ. ИНВ. №								ЛИСТ
										2

23171-04 15 ФОРМАТ А4

Номер загрузки	Тип усилия	Номер группы элементов							
		1	2	3	4	5	6	7	8
ЯРУС 3 СЕЧЕНИЕ 1									
1	N	0.0	0.0	0.0	0.0	-2.8	0.1	0.0	0.0
	MX	2.9	2.1	-2.6	-1.0	-0.1	-2.9	0.0	2.3
	QY	-1.0	-0.7	1.0	0.4	0.1	1.1	0.0	-0.3
	MU	-2.5	-3.1	-1.6	-0.3	1.2	1.1	0.0	-1.6
	QX	0.9	0.9	-0.6	-0.1	0.5	0.3	0.0	-0.6
8	N	0.0	0.0	0.0	0.0	0.6	-0.7	0.0	0.0
	MX	0.2	0.2	0.0	0.0	0.0	0.0	0.0	0.0
	QY	-0.1	-0.1	0.0	0.0	0.0	0.0	0.0	0.0
	MU	-2.6	-3.1	-2.6	-2.5	-2.6	-6.1	0.0	-2.2
	QX	-0.2	-0.8	-0.5	-0.5	-0.6	-1.4	0.0	-0.2
9	N	0.0	0.0	0.0	0.0	2.9	0.0	0.0	0.0
	MX	0.1	-0.7	0.1	-0.2	0.1	0.9	0.0	0.7
	QY	0.0	0.0	0.0	0.1	-0.1	-0.6	0.0	-0.5
	MU	0.0	0.0	0.0	0.0	0.0	0.0	0.0	0.0
	QX	0.0	0.0	0.0	0.0	0.0	0.0	0.0	0.0
14	N	49.4	66.8	66.1	85.7	23.9	65.8	0.0	53.6
	MX	0.6	-0.4	1.3	-0.5	-0.7	1.9	0.0	1.2
	QY	-0.5	0.6	-0.9	0.7	0.5	-1.3	0.0	-1.2
	MU	0.8	-2.2	-0.1	0.0	0.0	1.1	0.0	-0.1
	QX	0.4	-0.7	0.0	0.0	0.0	0.4	0.0	0.0
ЯРУС 3 СЕЧЕНИЕ 2									
1	N	0.0	0.0	0.0	0.0	2.8	-0.1	0.0	0.0
	MX	0.5	0.4	-0.6	-0.2	-0.1	-1.0	0.0	-1.1
	QY	1.0	0.7	-1.0	-0.4	-0.1	0.3	0.0	0.3
	MU	0.5	1.0	-0.4	0.0	0.5	0.3	0.0	-0.3
	QX	-0.9	-0.3	0.6	0.1	-0.5	-0.3	0.0	0.6
8	N	0.0	0.0	0.0	0.0	-0.6	0.7	0.0	0.0
	MX	0.1	0.1	0.0	0.0	0.0	0.0	0.0	0.0
	QY	0.1	0.1	0.0	0.0	0.0	0.0	0.0	0.0
	MU	1.6	1.0	0.9	0.9	0.5	0.7	0.0	1.5
	QX	0.2	0.8	0.5	0.5	0.6	1.4	0.0	0.2
9	N	0.0	0.0	0.0	0.0	-2.9	0.0	0.0	0.0
	MX	0.0	0.0	0.0	-0.1	0.1	0.9	0.0	1.1
	QY	0.0	0.0	0.0	-0.1	0.1	0.6	0.0	0.5
	MU	0.0	0.0	0.0	0.0	0.0	0.0	0.0	0.0
	QX	0.0	0.0	0.0	0.0	0.0	0.0	0.0	0.0
14	N	-49.4	-66.8	-66.1	-85.7	-23.9	-65.8	0.0	-53.6
	MX	0.9	-1.4	1.5	-1.7	-0.9	2.5	0.0	2.9
	QY	0.5	-0.6	0.9	-0.7	-0.5	1.3	0.0	1.2
	MU	0.7	2.4	-0.1	0.0	0.0	0.4	0.0	-0.1
	QX	-0.4	0.7	0.0	0.0	0.0	0.3	0.0	0.0

ЛИСТ
3

1.220.1-3М.0-1.4 19МУ1

Номер загрузки	Тип усилия	Номер группы элементов							
		1	2	3	4	5	6	7	8
ЯРУС 1 СЕЧЕНИЕ 1									
1	N	0.0	0.0	0.0	0.0	-17.3	-15.1	0.0	0.0
	MX	-4.5	-4.6	5.7	3.0	17.5	-7.5	-3.3	-7.1
	QY	1.0	0.9	-1.2	-0.6	-8.8	1.4	0.5	1.4
	MU	4.2	7.4	4.2	1.7	9.0	-9.6	3.2	4.2
	QX	-0.7	-0.9	0.8	0.3	1.9	5.5	-0.2	0.8
8	N	0.0	0.0	0.0	0.0	-1.7	-19.6	0.0	0.0
	MX	-0.2	-0.3	0.0	0.0	0.1	-0.1	0.0	0.1
	QY	0.0	0.1	0.0	0.0	0.0	0.0	0.0	0.0
	MU	0.4	0.7	0.0	-0.7	1.5	-12.2	-2.2	-0.2
	QX	0.4	0.5	0.3	0.2	2.3	-5.4	-0.3	0.3
9	N	0.0	0.0	0.0	0.0	-18.4	0.0	0.0	0.0
	MX	0.7	1.2	1.2	2.1	10.1	1.3	0.9	0.4
	QY	-0.1	-0.2	-0.2	-0.4	-4.9	-0.3	-0.1	0.0
	MU	0.0	0.0	0.0	0.0	0.0	0.0	0.0	0.0
	QX	0.0	0.0	0.0	0.0	0.0	0.0	0.0	0.0
14	N	104.6	138.8	137.4	175.5	151.5	116.7	82.4	117.4
	MX	0.8	0.4	1.7	0.7	3.8	-2.4	0.1	-2.9
	QY	-0.6	-0.1	-1.2	-0.2	-2.6	1.5	0.0	1.4
	MU	-1.2	2.0	0.1	0.0	0.1	-0.1	0.0	0.1
	QX	-0.8	-1.2	0.0	0.0	0.0	0.0	0.0	0.0
ЯРУС 1 СЕЧЕНИЕ 2									
1	N	0.0	0.0	0.0	0.0	17.3	15.1	0.0	0.0
	MX	0.5	0.9	-1.1	-0.7	17.6	1.9	1.2	1.7
	QY	-1.0	-0.9	1.2	0.6	8.8	-1.4	-0.5	-1.4
	MU	-0.6	-1.7	-0.9	-0.5	-1.2	-9.9	-1.2	-0.9
	QX	-0.9	0.9	-0.8	-0.3	-1.9	-5.5	0.2	-0.8
8	N	0.0	0.0	0.0	0.0	1.7	19.6	0.0	0.0
	MX	0.0	0.0	0.0	0.0	0.0	0.0	0.0	0.0
	QY	0.0	-0.1	0.0	0.0	0.0	0.0	0.0	0.0
	MU	1.3	1.6	1.4	1.6	7.7	-11.2	0.8	1.3
	QX	-0.4	-0.5	-0.3	-0.2	-2.3	5.4	0.3	-0.3
9	N	0.0	0.0	0.0	0.0	18.4	0.0	0.0	0.0
	MX	-0.1	-0.3	-0.2	-0.5	9.6	-0.8	-0.3	-0.5
	QY	0.1	0.2	0.2	0.4	4.9	0.0	0.1	0.0
	MU	0.0	0.0	0.0	0.0	0.0	0.0	0.0	0.0
	QX	0.0	0.0	0.0	0.0	0.0	0.0	0.0	0.0
14	N	-104.6	-138.8	-137.4	-175.5	-151.5	-116.7	-82.4	-117.4
	MX	1.4	-0.5	3.2	-1.1	6.7	-3.4	0.0	-2.8
	QY	0.6	-0.2	1.2	-0.4	2.6	-1.5	0.0	-1.4
	MU	-1.9	-3.2	0.0	0.0	0.0	-0.1	0.0	0.0
	QX	0.8	1.3	0.0	0.0	0.0	0.0	0.0	0.0

Безупрочно
ОПЕРАТОР СИСТЕМЫ
САПР КиевЗНИИЭП

ИНВ. ПОДП. ПОДПИСЬ И ДАТА ВЗАМ. ИНВ. №

1.220.1-3М.0-1.4 19МУ2

ГИП	Егужов							СТАДИЯ	ЛИСТ	ЛИСТОВ
НКОНТР.	Бойко							Р	1	3
РУК.ГР.	Рудавки							ГОСГРАЖДАНСТРОЙ		
ПРОВЕРИП	Футормая							КиевЗНИИЭП		
РАЗРАБ	Зуенко							ЗДАНИЕ 3Т 4.4.30-ЗАЛ(12)40-4.0		

Номер загрузки	Тип усилия	Номер группы элементов							
		1	2	3	4	5	6	7	8
ЯРУС 2 СЕЧЕНИЕ 1									
1	N	0.0	0.0	0.0	0.0	1.4	1.2	0.0	0.0
	MX	-0.5	-0.9	1.1	0.7	-0.2	-0.8	-1.2	-1.7
	QY	1.0	0.9	-1.2	-0.6	0.2	0.7	0.5	1.4
	MU	0.6	1.7	0.9	0.5	0.9	0.1	1.2	0.9
	QX	0.9	-0.9	0.8	0.3	0.9	-0.1	-0.2	0.8
8	N	0.0	0.0	0.0	0.0	1.2	-4.8	0.0	0.0
	MX	0.0	0.0	0.0	0.0	-0.1	0.0	0.0	0.0
	QY	0.0	0.1	0.0	0.0	0.1	0.0	0.0	0.0
	MU	-1.3	-1.6	-1.4	-1.6	-0.1	0.8	-0.8	-1.3
	QX	0.4	0.5	0.3	0.2	1.3	0.6	-0.3	0.3
9	N	0.0	0.0	0.0	0.0	3.7	0.0	0.0	0.0
	MX	0.1	0.3	0.2	0.5	0.0	0.1	0.3	0.5
	QY	-0.1	-0.2	-0.2	-0.4	0.0	-0.1	-0.1	0.0
	MU	0.0	0.0	0.0	0.0	0.0	0.0	0.0	0.0
	QX	0.0	0.0	0.0	0.0	0.0	0.0	0.0	0.0
14	N	74.3	102.2	101.5	134.0	61.8	67.0	44.1	84.7
	MX	0.7	-0.2	1.4	-0.4	0.6	0.7	0.0	-0.5
	QY	-0.5	0.2	-1.2	0.4	-0.2	-0.6	0.0	1.4
	MU	0.9	1.4	0.0	0.0	0.0	-0.3	0.0	0.0
	QX	0.8	1.3	0.0	0.0	0.0	-0.6	0.0	0.0
ЯРУС 2 СЕЧЕНИЕ 2									
1	N	0.0	0.0	0.0	0.0	-1.4	-1.2	0.0	0.0
	MX	-1.9	-1.3	1.7	0.7	-0.2	0.8	0.0	-1.5
	QY	-1.0	-0.9	1.2	0.6	-0.2	0.6	-0.5	-1.4
	MU	1.6	2.0	1.0	0.2	1.2	-0.1	0.0	1.0
	QX	0.7	0.9	-0.8	-0.3	-0.9	-0.1	0.2	-0.8
8	N	0.0	0.0	0.0	0.0	-1.2	4.8	0.0	0.0
	MX	-0.1	-0.1	0.0	0.0	-0.1	0.0	0.0	0.0
	QY	0.0	-0.1	0.0	0.0	-0.1	0.0	0.0	0.0
	MU	2.3	2.9	2.3	2.2	3.1	0.9	0.0	1.9
	QX	-0.4	-0.5	-0.3	-0.2	-1.3	-0.6	0.3	-0.3
9	N	0.0	0.0	0.0	0.0	-3.7	0.0	0.0	0.0
	MX	0.3	0.3	0.3	0.4	0.0	0.2	0.0	-0.5
	QY	0.1	0.2	0.2	0.4	0.0	0.1	0.1	0.0
	MU	0.0	0.0	0.0	0.0	0.0	0.0	0.0	0.0
	QX	0.0	0.0	0.0	0.0	0.0	0.0	0.0	0.0
14	N	-74.3	-102.2	-101.5	-134.0	-61.8	-67.0	-44.1	-84.7
	MX	-0.7	0.3	1.5	-0.5	-0.1	-1.1	0.0	-2.9
	QY	-0.4	0.1	1.2	-0.4	0.2	-0.7	0.0	-1.4
	MU	-1.0	1.8	0.1	0.0	0.0	-1.1	0.0	0.1
	QX	0.7	1.2	0.0	0.0	0.0	-0.5	0.0	0.0

1.220.1-3М.0-1.4 19МУ2

ЛИСТ

2

ФОРМАТ А4

Номер загрузки	Тип усилия	Номер группы элементов							
		1	2	3	4	5	6	7	8
ЯРУС 3 СЕЧЕНИЕ 1									
1	N	0.0	0.0	0.0	0.0	1.3	0.0	0.0	0.0
	MX	1.9	1.3	-1.7	-0.7	-0.1	-2.2	0.0	1.5
	QY	-0.7	-0.5	0.7	0.3	0.0	0.8	0.0	-0.2
	MU	-1.6	-2.0	-1.0	-0.2	-0.9	0.8	0.0	-1.0
	QX	0.5	0.2	-0.4	-0.1	-0.4	0.2	0.0	-0.4
8	N	0.0	0.0	0.0	0.0	0.6	-0.8	0.0	0.0
	MX	0.1	0.1	0.0	0.0	0.0	0.0	0.0	0.0
	QY	-0.1	-0.1	0.0	0.0	0.0	0.0	0.0	0.0
	MU	-2.3	-2.9	-2.3	-2.2	-2.5	-7.1	0.0	-1.9
	QX	-0.1	-0.7	-0.4	-0.4	-0.6	-1.7	0.0	-0.1
9	N	0.0	0.0	0.0	0.0	2.6	0.0	0.0	0.0
	MX	-0.3	-0.3	-0.3	-0.4	0.1	0.7	0.0	0.5
	QY	0.1	0.1	0.1	0.2	0.0	-0.5	0.0	-0.5
	MU	0.0	0.0	0.0	0.0	0.0	0.0	0.0	0.0
	QX	0.0	0.0	0.0	0.0	0.0	0.0	0.0	0.0
14	N	49.4	66.8	66.1	85.7	25.5	65.6	0.0	53.6
	MX	0.8	-0.3	1.4	-0.5	-0.6	1.8	0.0	1.0
	QY	-0.5	0.5	-0.9	0.3	0.4	-1.3	0.0	-1.2
	MU	1.0	-2.3	-0.1	0.0	0.0	1.1	0.0	-0.1
	QX	0.5	-0.7	0.0	0.0	0.0	0.4	0.0	0.0
ЯРУС 3 СЕЧЕНИЕ 2									
1	N	0.0	0.0	0.0	0.0	-1.3	0.0	0.0	0.0
	MX	0.4	0.3	-0.4	-0.2	0.0	-0.8	0.0	-0.8
	QY	0.7	0.5	-0.7	-0.3	0.0	0.2	0.0	0.2
	MU	-0.3	0.7	-0.2	0.0	0.4	0.2	0.0	-0.2
	QX	-0.5	-0.2	0.4	0.1	0.4	-0.2	0.0	0.4
8	N	0.0	0.0	0.0	0.0	-0.6	0.8	0.0	0.0
	MX	0.1	0.1	0.0	0.0	0.0	0.0	0.0	0.0
	QY	0.1	0.1	0.0	0.0	0.0	0.0	0.0	0.0
	MU	1.7	1.0	1.0	1.0	0.5	0.6	0.0	1.7
	QX	0.1	0.7	0.4	0.4	0.6	1.7	0.0	0.1
9	N	0.0	0.0	0.0	0.0	-2.6	0.0	0.0	0.0
	MX	-0.1	-0.1	-0.1	-0.1	0.1	1.0	0.0	1.2
	QY	-0.1	-0.1	-0.1	-0.2	0.0	0.5	0.0	0.5
	MU	0.0	0.0	0.0	0.0	0.0	0.0	0.0	0.0
	QX	0.0	0.0	0.0	0.0	0.0	0.0	0.0	0.0
14	N	-49.4	-66.8	-66.1	-85.7	-25.5	-65.8	0.0	-53.6
	MX	0.9	-1.4	1.6	-1.7	-0.8	2.5	0.0	3.0
	QY	0.5	-0.5	0.9	-0.6	-0.4	1.3	0.0	1.2
	MU	0.7	2.3	0.0	0.0	0.0	0.4	0.0	-0.1
	QX	-0.5	0.7	0.0	0.0	0.0	0.4	0.0	0.0

1.220.1-3М.0-1.4 19МУ2

ЛИСТ

3

23171-04 17

ФОРМАТ А4

Номер загрузки	Тип усилия	Номер группы элементов							
		1	2	3	4	5	6	7	8
ЯРУС 1 СЕЧЕНИЕ 1									
1	N	0.0	0.0	0.0	0.0	-7.9	-6.5	0.0	0.0
	MX	-7.1	-6.7	8.3	3.8	36.6	-15.5	-6.6	-11.3
	QY	2.1	1.8	-2.2	-1.0	-28.3	5.3	1.8	3.0
	MU	7.0	11.1	6.5	2.6	14.4	-19.2	6.4	6.5
	QX	-1.4	-2.0	1.7	0.7	-1.9	-14.9	-0.8	1.7
8	N	0.0	0.0	0.0	0.0	2.0	-28.0	0.0	0.0
	MX	0.2	0.2	0.1	0.0	0.1	0.1	-0.1	-0.1
	QY	-0.1	-0.1	0.0	0.0	0.0	0.0	0.0	0.0
	MU	-1.0	-1.3	-1.3	-1.4	-0.9	-5.7	-0.4	-1.2
	QX	-0.3	-0.4	-0.4	-0.4	-0.2	-4.7	-0.1	-0.4
9	N	0.0	0.0	0.0	0.0	25.8	0.0	0.0	0.0
	MX	0.4	0.5	0.6	0.8	7.8	0.8	0.5	0.8
	QY	-0.1	-0.1	-0.1	-0.2	-6.4	-0.2	-0.1	-0.2
	MU	0.0	0.0	0.0	0.0	0.0	0.0	0.0	0.0
	QX	0.0	0.0	0.0	0.0	0.0	0.0	0.0	0.0
14	N	129.5	174.1	172.7	223.8	167.9	142.8	126.5	148.5
	MX	0.5	-0.1	0.6	-0.2	-7.5	1.1	0.0	0.1
	QY	-0.7	0.2	-1.4	0.1	7.9	-1.4	0.0	0.8
	MU	0.8	-1.0	-0.1	0.0	0.0	3.8	0.0	-0.1
	QX	1.0	-1.5	0.0	0.0	0.0	-4.1	0.0	0.0
ЯРУС 1 СЕЧЕНИЕ 2									
1	N	0.0	0.0	0.0	0.0	7.9	6.5	0.0	0.0
	MX	2.0	2.2	-2.7	-1.3	34.2	2.3	2.2	3.7
	QY	-2.1	-1.8	2.2	1.0	28.3	-5.3	-1.8	-3.0
	MU	-1.9	-3.7	-2.1	-0.9	-3.9	-18.1	-2.1	-2.2
	QX	1.4	2.0	-1.7	-0.7	1.9	14.9	0.6	-1.7
8	N	0.0	0.0	0.0	0.0	-2.0	28.0	0.0	0.0
	MX	0.0	0.0	0.0	0.0	0.1	0.0	0.0	0.0
	QY	-0.1	0.1	0.0	0.0	0.0	0.0	0.0	0.0
	MU	0.1	0.2	0.2	0.4	0.4	-6.2	0.2	0.2
	QX	0.4	0.4	0.4	0.4	0.2	4.8	0.7	0.4
9	N	0.0	0.0	0.0	0.0	-25.8	0.0	0.0	0.0
	MX	-0.1	-0.2	-0.2	-0.3	8.3	-0.2	-0.2	-0.2
	QY	0.1	0.1	0.1	0.2	6.4	0.2	0.1	0.2
	MU	0.0	0.0	0.0	0.0	0.0	0.0	0.0	0.0
	QX	0.0	0.0	0.0	0.0	0.0	0.0	0.0	0.0
14	N	-129.5	-174.1	-172.7	-223.8	-167.9	-142.8	-126.5	-148.5
	MX	1.3	-0.5	3.0	-1.0	12.7	2.5	0.0	-2.1
	QY	0.7	-0.2	1.4	-0.4	7.9	1.4	0.0	-0.8
	MU	1.7	-2.9	0.0	0.0	0.0	6.4	0.0	0.0
	QX	-1.0	-1.5	0.0	0.0	0.0	4.1	0.0	0.0

Номер загрузки	Тип усилия	Номер группы элементов							
		1	2	3	4	5	6	7	8
ЯРУС 2 СЕЧЕНИЕ 1									
1	N	0.0	0.0	0.0	0.0	-9.8	-7.8	0.0	0.0
	MX	-2.0	-2.2	2.7	1.3	-0.4	-2.2	-2.2	-3.7
	QY	2.1	1.8	-2.2	-1.0	0.3	2.4	1.8	3.0
	MU	1.9	3.7	2.1	0.9	2.0	0.3	2.1	2.2
	QX	-1.4	-2.0	1.7	0.7	-0.9	0.2	-0.8	1.7
8	N	0.0	0.0	0.0	0.0	-1.5	-13.2	0.0	0.0
	MX	0.0	0.0	0.0	0.0	-0.1	0.0	0.0	0.0
	QY	-0.1	-0.1	0.0	0.0	0.0	0.0	0.0	0.0
	MU	-0.1	-0.2	-0.2	-0.4	-0.3	-0.5	-0.2	-0.2
	QX	-0.4	-0.4	-0.4	-0.4	-0.2	-0.3	-0.1	-0.4
9	N	0.0	0.0	0.0	0.0	-10.0	0.0	0.0	0.0
	MX	0.1	0.2	0.2	0.3	0.3	0.1	0.2	0.2
	QY	-0.1	-0.1	-0.1	-0.2	-0.2	-0.1	-0.1	-0.2
	MU	0.0	0.0	0.0	0.0	0.0	0.0	0.0	0.0
	QX	0.0	0.0	0.0	0.0	0.0	0.0	0.0	0.0
14	N	99.2	137.5	136.8	182.4	72.5	66.6	88.2	115.7
	MX	0.9	-0.3	1.7	-0.5	0.8	0.7	0.0	-1.2
	QY	-0.7	0.2	-1.4	0.4	-0.4	-0.5	0.0	0.8
	MU	-1.2	1.6	0.0	0.0	0.0	-0.5	0.0	0.0
	QX	-1.0	-1.5	0.0	0.0	0.0	-0.1	0.0	0.0
ЯРУС 2 СЕЧЕНИЕ 2									
1	N	0.0	0.0	0.0	0.0	9.8	7.8	0.0	0.0
	MX	-2.9	-2.1	2.6	1.0	-0.3	-3.5	-2.0	-3.5
	QY	-2.1	-1.8	2.2	1.0	-0.3	-2.4	-1.8	-3.0
	MU	2.8	3.4	2.0	0.6	2.4	0.2	1.9	2.0
	QX	1.4	2.0	-1.7	-0.7	-1.8	-0.2	0.8	-1.7
8	N	0.0	0.0	0.0	0.0	1.5	13.2	0.0	0.0
	MX	0.2	0.2	0.0	0.0	0.0	0.0	0.0	0.0
	QY	-0.1	0.1	0.0	0.0	0.0	0.0	0.0	0.0
	MU	-0.8	-0.8	-0.7	-0.7	-0.2	-0.3	0.0	-0.7
	QX	0.3	0.4	0.4	0.4	0.2	0.3	0.1	0.4
9	N	0.0	0.0	0.0	0.0	10.0	0.0	0.0	0.0
	MX	0.1	0.1	0.1	0.2	0.2	0.1	0.1	0.3
	QY	0.1	0.1	0.1	0.2	0.2	0.1	0.1	0.2
	MU	0.0	0.0	0.0	0.0	0.0	0.0	0.0	0.0
	QX	0.0	0.0	0.0	0.0	0.0	0.0	0.0	0.0
14	N	-99.2	-137.5	-136.8	-182.4	-72.5	-66.6	-88.2	-115.7
	MX	0.8	-0.3	1.7	-0.6	0.1	0.6	0.0	-0.6
	QY	0.7	-0.2	1.4	-0.4	0.4	0.5	0.0	-0.8
	MU	1.2	-1.9	-0.1	0.0	0.0	-0.2	0.0	-0.1
	QX	-1.0	1.5	0.0	0.0	0.0	0.1	0.0	0.0

Безудова
 ОПЕРАТОР СИСТЕМЫ
 САПР КиевЗНИИЭП

ИВБ № ПОДП
 ПОДПИСЬ И ДАТА
 ВЗАМ ИВБ №

1.220.1-3М.0-1.4 19МУ3			
ГИП	Егунов	СТАДИЯ	ЛИСТ
И.КОНТР.	Бойко	Р	1
РУК.ГР	Рудавин	ГОСГРАЖДАНСТРОЙ	
ПРОВЕРИЛ	Футорман	КиевЗНИИЭП	
РАЗРАБ	Зуевко	ЗДАНИЕ	
4Т 4.4.30-ЗАЛ(12)40-2.5			

1.220.1-3М.0-1.4 19МУ3		ЛИСТ
23171-04 18		2

Номер загрузки	Тип усилия	Номер группы элементов							
		1	2	3	4	5	6	7	8
ЯРУС 3 СЕЧЕНИЕ 1									
1	N	0.0	0.0	0.0	0.0	-3.1	-1.8	0.0	0.0
	MX	2.9	2.1	-2.6	-1.0	-0.1	2.7	2.0	3.5
	QY	-1.1	-0.8	1.0	0.4	0.1	-1.2	-0.6	-1.2
	MU	-2.8	-3.4	-2.0	-0.6	-1.6	0.1	-1.9	-2.0
	QX	0.8	0.9	-0.7	-0.2	0.4	0.1	0.3	-0.7
8	N	0.0	0.0	0.0	0.0	-1.0	-8.8	0.0	0.0
	MX	-0.2	-0.2	0.0	0.0	0.0	0.0	0.0	0.0
	QY	0.1	0.1	0.0	0.0	0.0	0.0	0.0	0.0
	MU	0.8	0.8	0.7	0.7	1.2	-0.1	0.0	0.7
	QX	1.0	1.2	1.1	1.0	1.3	0.0	0.0	0.9
9	N	0.0	0.0	0.0	0.0	6.0	0.0	0.0	0.0
	MX	-0.1	-0.1	-0.1	-0.2	0.2	-0.2	-0.1	-0.3
	QY	0.0	0.1	0.1	0.1	-0.1	0.1	0.0	0.3
	MU	0.0	0.0	0.0	0.0	0.0	0.0	0.0	0.0
	QX	0.0	0.0	0.0	0.0	0.0	0.0	0.0	0.0
14	N	74.3	102.2	101.5	134.0	32.7	54.3	44.1	84.7
	MX	0.5	-0.2	1.2	-0.4	-0.4	-0.6	0.0	-1.3
	QY	-0.3	0.2	-0.8	0.3	0.3	0.5	0.0	1.3
	MU	-0.8	1.5	0.1	0.0	0.0	-0.7	0.0	0.1
	QX	-0.5	1.0	0.1	0.0	0.0	0.5	0.0	0.0
ЯРУС 3 СЕЧЕНИЕ 2									
1	N	0.0	0.0	0.0	0.0	3.1	1.8	0.0	0.0
	MX	0.7	0.5	-0.7	-0.3	-0.1	1.1	0.0	0.5
	QY	1.1	0.8	-1.0	-0.4	-0.1	1.2	0.6	1.2
	MU	-0.6	-0.8	-0.4	-0.1	-0.6	0.1	0.0	-0.4
	QX	-0.8	-0.9	0.7	0.2	-0.4	-0.1	0.2	0.7
8	N	0.0	0.0	0.0	0.0	1.0	8.8	0.0	0.0
	MX	-0.2	-0.2	0.0	0.0	0.0	0.0	0.0	0.0
	QY	-0.1	-0.1	0.0	0.0	0.0	0.0	0.0	0.0
	MU	2.9	3.3	2.8	2.7	3.2	0.1	0.0	2.4
	QX	-1.0	-1.2	-1.1	-1.0	-1.3	0.0	0.0	-0.9
9	N	0.0	0.0	0.0	0.0	-6.0	0.0	0.0	0.0
	MX	0.0	0.0	0.0	0.0	0.1	-0.3	0.0	-0.8
	QY	0.0	-0.1	-0.1	-0.1	0.1	-0.1	0.0	-0.3
	MU	0.0	0.0	0.0	0.0	0.0	0.0	0.0	0.0
	QX	0.0	0.0	0.0	0.0	0.0	0.0	0.0	0.0
14	N	-74.3	-102.2	-101.5	-134.0	-32.7	-54.3	-44.1	-84.7
	MX	-0.7	0.4	1.4	-0.5	-0.6	-1.0	0.0	-3.0
	QY	-0.3	0.2	0.8	-0.3	-0.3	-0.5	0.0	-1.3
	MU	-0.9	1.8	0.1	0.0	0.0	-1.3	0.0	0.1
	QX	0.5	0.9	-0.1	0.0	0.0	-0.5	0.0	0.0

1.220.1-3М.0-1.4 19МУ3

ЛИСТ

3

ФОРМАТ А4

Номер загрузки	Тип усилия	Номер группы элементов							
		1	2	3	4	5	6	7	8
ЯРУС 4 СЕЧЕНИЕ 1									
1	N	0.0	0.0	0.0	0.0	-0.6	0.0	0.0	0.0
	MX	-0.7	-0.5	0.7	0.3	-0.0	0.1	0.0	-0.5
	QY	0.2	0.2	-0.3	-0.1	0.0	0.0	0.0	0.1
	MU	0.6	0.8	0.4	0.1	-0.1	-0.1	0.0	0.4
	QX	-0.2	-0.1	0.2	0.0	0.0	0.0	0.0	0.1
8	N	0.0	0.0	0.0	0.0	0.5	-0.7	0.0	0.0
	MX	0.2	0.2	0.0	0.0	0.0	0.0	0.0	0.0
	QY	-0.1	-0.1	0.0	0.0	0.0	0.0	0.0	0.0
	MU	-2.9	-3.3	-2.8	-2.7	-2.6	-5.9	0.0	-2.4
	QX	-0.3	-0.8	-0.6	-0.5	-0.7	-1.3	0.0	-0.3
9	N	0.0	0.0	0.0	0.0	3.0	0.0	0.0	0.0
	MX	0.0	0.0	0.0	0.0	0.1	1.0	0.0	0.8
	QY	0.0	0.0	0.0	0.0	-0.1	-0.6	0.0	-0.5
	MU	0.0	0.0	0.0	0.0	0.0	0.0	0.0	0.0
	QX	0.0	0.0	0.0	0.0	0.0	0.0	0.0	0.0
14	N	49.4	66.8	66.1	85.7	18.0	65.8	0.0	53.6
	MX	0.8	-0.4	1.6	-0.5	-0.9	1.9	0.0	1.1
	QY	-0.5	0.6	-1.0	0.3	0.6	-1.3	0.0	-1.2
	MU	1.0	-2.4	-0.1	0.0	0.0	1.5	0.0	-0.1
	QX	0.5	-0.7	0.0	0.0	0.0	0.5	0.0	-0.1
ЯРУС 4 СЕЧЕНИЕ 2									
1	N	0.0	0.0	0.0	0.0	0.6	0.0	0.0	0.0
	MX	0.1	-0.1	0.2	0.1	0.0	0.0	0.0	0.3
	QY	0.2	-0.2	0.3	0.1	0.0	0.0	0.0	-0.1
	MU	-0.1	-0.2	0.1	0.0	0.0	-0.1	0.0	0.0
	QX	0.2	0.1	-0.2	0.0	0.0	0.0	0.0	-0.1
8	N	0.0	0.0	0.0	0.0	-0.5	0.7	0.0	0.0
	MX	0.1	0.1	0.0	0.0	0.0	0.0	0.0	0.0
	QY	0.1	0.1	0.0	0.0	0.0	0.0	0.0	0.0
	MU	1.5	0.9	0.9	0.9	0.4	0.7	0.0	1.5
	QX	0.3	0.8	0.6	0.5	0.7	1.3	0.0	0.3
9	N	0.0	0.0	0.0	0.0	-3.0	0.0	0.0	0.0
	MX	0.0	0.0	0.0	0.0	0.1	0.9	0.0	1.0
	QY	0.0	0.0	0.0	0.0	0.1	0.6	0.0	0.5
	MU	0.0	0.0	0.0	0.0	0.0	0.0	0.0	0.0
	QX	0.0	0.0	0.0	0.0	0.0	0.0	0.0	0.0
14	N	-49.4	-66.8	-66.1	-85.7	-18.0	-65.8	0.0	-53.6
	MX	0.9	-1.4	1.6	-1.7	-1.1	2.5	0.0	2.9
	QY	0.5	-0.6	1.0	-0.6	-0.6	1.3	0.0	1.2
	MU	0.7	2.3	-0.1	0.0	0.0	0.5	0.0	-0.1
	QX	-0.5	0.7	0.0	0.0	0.0	0.5	0.0	0.1

1.220.1-3М.0-1.4 19МУ3

ЛИСТ

4

23171-04 19

ФОРМАТ А4

Номер загрузки	Тип усилия	Номер группы элементов							
		1	2	3	4	5	6	7	8
ЯРУС 1 СЕЧЕНИЕ 1									
1	N	0.0	0.0	0.0	0.0	-17.5	-14.4	0.0	0.0
	MX	-4.4	-4.5	5.8	3.2	18.3	-9.9	-4.4	-7.7
	QY	1.0	0.9	-1.2	-0.6	-9.1	2.7	0.9	1.6
	MU	4.3	7.5	4.3	1.8	9.3	-9.9	4.3	4.3
	QX	-0.7	-1.1	0.9	0.3	-1.1	-5.0	0.9	0.9
8	N	0.0	0.0	0.0	0.0	2.2	-28.9	0.0	0.0
	MX	0.2	0.2	0.0	0.0	0.0	0.1	-0.1	-0.1
	QY	-0.1	-0.1	0.0	0.0	0.0	0.0	0.0	0.0
	MU	-1.5	-2.3	-2.3	-3.4	-3.3	-8.2	-1.6	-2.2
	QX	-0.4	-0.5	-0.5	-0.7	-0.7	-4.1	-0.3	-0.5
9	N	0.0	0.0	0.0	0.0	28.7	0.0	0.0	0.0
	MX	0.8	1.5	1.5	2.5	12.6	1.8	1.5	1.6
	QY	-0.2	-0.3	-0.3	-0.5	-6.2	-0.5	-0.3	-0.3
	MU	0.0	0.0	0.0	0.0	0.0	0.0	0.0	0.0
	QX	0.0	0.0	0.0	0.0	0.0	0.0	0.0	0.0
14	N	129.5	174.1	172.7	223.8	189.3	137.1	126.5	148.5
	MX	0.9	-0.3	1.7	-0.6	-5.8	1.7	-0.1	-0.8
	QY	-0.6	0.2	-1.2	0.4	3.9	-1.1	0.0	0.7
	MU	1.2	-1.9	-0.1	0.0	0.0	2.0	0.0	-0.1
	QX	0.8	-1.3	0.0	0.0	0.0	-1.4	0.0	0.0
ЯРУС 1 СЕЧЕНИЕ 2									
1	N	0.0	0.0	0.0	0.0	17.5	14.4	0.0	0.0
	MX	0.5	0.8	-1.1	-0.7	18.3	-0.9	0.9	1.5
	QY	-1.0	-0.9	1.2	0.6	9.1	-2.7	-0.9	-1.6
	MU	-0.5	-1.4	-0.8	-0.4	-0.7	-10.0	-0.8	-0.8
	QX	-1.0	1.1	-0.9	-0.3	1.1	5.0	0.4	-0.9
8	N	0.0	0.0	0.0	0.0	-2.2	28.9	0.0	0.0
	MX	0.0	0.0	0.0	0.0	0.1	0.0	0.0	0.0
	QY	0.1	0.1	0.0	0.0	0.0	0.0	0.0	0.0
	MU	-0.1	0.2	0.2	0.6	0.6	-8.1	0.4	0.3
	QX	0.4	0.5	0.5	0.7	0.7	4.1	0.3	0.5
9	N	0.0	0.0	0.0	0.0	-28.7	0.0	0.0	0.0
	MX	-0.1	-0.3	-0.3	-0.6	12.3	0.0	-0.3	-0.3
	QY	0.2	0.3	0.3	0.5	6.2	0.5	0.3	0.3
	MU	0.0	0.0	0.0	0.0	0.0	0.0	0.0	0.0
	QX	0.0	0.0	0.0	0.0	0.0	0.0	0.0	0.0
14	N	-129.5	-174.1	-172.7	-223.8	-189.3	-137.1	-126.5	-148.5
	MX	1.4	-0.5	3.3	-1.0	10.1	2.8	0.0	-2.1
	QY	0.6	-0.2	1.2	-0.4	3.8	1.1	0.0	-0.7
	MU	1.9	-3.2	0.0	0.0	0.0	3.6	0.0	0.0
	QX	-0.8	1.3	0.0	0.0	0.0	1.4	0.0	0.0

1.220.1-3М.0-1.4 19МУ4

ГМП	Егузов		СТАДИЯ	ЛИСТ	ЛИСТОВ
И.КОНТР.	Бойко		Р	1	4
РУКЛР.	Рудавки		ГОСГРАЖДАНСТРОЙ		
ПРОВЕРИЛ	Футормая		КиевЗНИИЭП		
РАЗРАБ	Зуежко		4Т 4.4.30-ЗАЛ(12)40-4.0		

Номер загрузки	Тип усилия	Номер группы элементов							
		1	2	3	4	5	6	7	8
ЯРУС 2 СЕЧЕНИЕ 1									
1	N	0.0	0.0	0.0	0.0	2.0	3.4	0.0	0.0
	MX	-0.5	-0.8	1.1	0.7	-0.3	-0.9	-0.9	-1.5
	QY	1.0	0.9	-1.2	-0.6	0.2	1.3	0.9	1.6
	MU	0.5	1.4	0.8	0.4	0.9	0.2	0.8	0.8
	QX	1.0	-1.1	0.9	0.3	-0.5	0.2	-0.4	0.9
8	N	0.0	0.0	0.0	0.0	-1.6	-12.0	0.0	0.0
	MX	0.0	0.0	0.0	0.0	-0.1	0.0	0.0	0.0
	QY	-0.1	-0.1	0.0	0.0	0.1	0.0	0.0	0.0
	MU	0.1	-0.2	-0.2	-0.6	-0.5	-0.3	-0.4	-0.3
	QX	-0.4	-0.5	-0.5	-0.7	-0.4	-0.2	-0.3	-0.5
9	N	0.0	0.0	0.0	0.0	-8.6	0.0	0.0	0.0
	MX	0.1	0.3	0.3	0.6	0.1	0.2	0.3	0.3
	QY	-0.2	-0.3	-0.3	-0.5	-0.1	-0.2	-0.3	-0.3
	MU	0.0	0.0	0.0	0.0	0.0	0.0	0.0	0.0
	QX	0.0	0.0	0.0	0.0	0.0	0.0	0.0	0.0
14	N	99.2	137.5	136.8	182.4	81.3	65.3	88.2	115.7
	MX	0.7	-0.2	1.4	-0.4	1.2	0.6	0.0	-1.1
	QY	-0.6	0.2	-1.2	0.4	-0.6	-0.4	0.0	0.7
	MU	-0.9	1.3	0.0	0.0	0.0	-0.5	0.0	0.0
	QX	-0.8	1.2	0.0	0.0	0.0	-0.1	0.0	0.0
ЯРУС 2 СЕЧЕНИЕ 2									
1	N	0.0	0.0	0.0	0.0	-2.0	-3.4	0.0	0.0
	MX	-1.9	-1.3	1.8	0.7	-0.3	-2.2	-1.3	-2.3
	QY	-1.0	-0.9	1.2	0.6	-0.2	-1.3	-0.9	-1.6
	MU	1.8	2.2	1.3	0.4	1.5	0.2	1.2	1.3
	QX	0.7	1.1	-0.9	-0.3	0.5	-0.2	-0.9	-0.9
8	N	0.0	0.0	0.0	0.0	1.6	12.0	0.0	0.0
	MX	0.2	0.1	0.0	0.0	-0.1	0.0	0.0	0.0
	QY	0.1	0.1	0.0	0.0	-0.1	0.0	0.0	0.0
	MU	-1.0	-1.0	-1.0	-1.0	-0.6	-0.2	-0.3	-0.9
	QX	0.4	0.5	0.5	0.7	0.4	0.2	0.3	0.5
9	N	0.0	0.0	0.0	0.0	8.6	0.0	0.0	0.0
	MX	0.3	0.4	0.4	0.5	0.1	0.4	0.4	0.5
	QY	0.2	0.3	0.3	0.5	0.1	0.2	0.3	0.3
	MU	0.0	0.0	0.0	0.0	0.0	0.0	0.0	0.0
	QX	0.0	0.0	0.0	0.0	0.0	0.0	0.0	0.0
14	N	-99.2	-137.5	-136.8	-182.4	-81.3	-65.3	-88.2	-115.7
	MX	0.7	-0.3	1.5	-0.6	0.3	0.4	0.0	-0.6
	QY	0.6	-0.2	1.2	-0.4	0.6	0.4	0.0	-0.7
	MU	1.0	-1.7	-0.1	0.0	0.0	-0.2	0.0	-0.1
	QX	-0.8	1.3	0.0	0.0	0.0	0.1	0.0	0.0

ИНВЕН ПОДЛ ПОДПИСЬ И ДАТА ВЗАМ ИНВЕН

1.220.1-3М.0-1.4 19МУ4

Номер загрузки	Тип усилия	Номер группы элементов							
		1	2	3	4	5	6	7	8
ЯРУС 3 СЕЧЕНИЕ 1									
1	N	0.0	0.0	0.0	0.0	1.5	1.5	0.0	0.0
	MX	1.9	1.3	-1.8	-0.7	-0.1	1.9	1.3	2.3
	QY	-0.7	-0.5	0.7	0.3	0.0	-0.8	-0.4	-0.8
	MU	-1.8	-2.2	-1.3	-0.4	-1.1	0.1	-1.2	-1.3
	QX	0.5	0.6	-0.5	-0.1	0.3	0.0	-0.4	-0.5
8	N	0.0	0.0	0.0	0.0	-1.0	-8.7	0.0	0.0
	MX	-0.2	-0.1	0.0	0.0	0.0	0.0	0.0	0.0
	QY	0.1	0.1	0.0	0.0	0.0	0.0	0.0	0.0
	MU	1.0	1.0	1.0	1.0	1.5	-0.1	0.3	0.9
	QX	1.1	1.3	1.2	1.1	1.5	0.0	0.1	1.0
9	N	0.0	0.0	0.0	0.0	5.7	-0.1	0.0	0.0
	MX	-0.3	-0.4	-0.4	-0.5	0.1	-0.4	-0.4	-0.5
	QY	0.1	0.1	0.1	0.2	-0.1	0.2	0.1	0.4
	MU	0.0	0.0	0.0	0.0	0.0	0.0	0.0	0.0
	QX	0.0	0.0	0.0	0.0	0.0	0.0	0.0	0.0
14	N	74.3	102.2	101.5	134.0	35.1	54.1	44.1	84.7
	MX	0.7	-0.3	1.4	-0.4	-0.3	0.6	0.0	-1.3
	QY	-0.4	0.2	-0.9	0.3	0.3	-0.4	0.0	1.3
	MU	-1.0	1.7	0.1	0.0	0.0	-0.8	0.0	0.1
	QX	-0.6	1.1	0.1	0.0	0.0	-0.6	0.0	0.0
ЯРУС 3 СЕЧЕНИЕ 2									
1	N	0.0	0.0	0.0	0.0	-1.5	-1.5	0.0	0.0
	MX	0.4	0.3	-0.5	-0.2	-0.1	0.8	0.0	0.3
	QY	0.7	0.5	-0.7	-0.3	0.0	0.8	0.4	0.8
	MU	-0.4	-0.5	-0.3	-0.1	-0.4	0.1	0.0	-0.3
	QX	-0.5	-0.6	0.5	0.1	-0.3	0.0	0.1	0.5
8	N	0.0	0.0	0.0	0.0	1.0	8.7	0.0	0.0
	MX	-0.3	-0.2	0.0	0.0	0.0	0.0	0.0	0.1
	QY	-0.1	-0.1	0.0	0.0	0.0	0.0	0.0	0.0
	MU	2.9	3.3	2.8	2.7	3.3	0.1	0.0	2.5
	QX	-1.1	-1.3	-1.2	-1.1	-1.5	0.0	-0.1	-1.0
9	N	0.0	0.0	0.0	0.0	-5.7	0.1	0.0	0.0
	MX	-0.1	-0.1	-0.1	-0.1	0.1	-0.4	0.0	-0.8
	QY	-0.1	-0.1	-0.1	-0.2	0.1	-0.2	-0.1	-0.4
	MU	0.0	0.0	0.0	0.0	0.0	0.0	0.0	0.0
	QX	0.0	0.0	0.0	0.0	0.0	0.0	0.0	0.0
14	N	-74.3	-102.2	-101.5	-134.0	-35.1	-54.1	-44.1	-84.7
	MX	-0.7	0.4	1.4	-0.5	-0.6	-1.1	0.0	-3.0
	QY	-0.3	0.2	0.9	-0.3	-0.3	-0.5	0.0	-1.3
	MU	-1.0	1.8	0.1	0.0	0.0	-1.3	0.0	0.1
	QX	0.6	1.0	-0.1	0.0	0.0	-0.5	0.0	0.0

1.220.1-3М.0-1.4 19МУ4

ЛИСТ

3

ФОРМАТ А4

Номер загрузки	Тип усилия	Номер группы элементов							
		1	2	3	4	5	6	7	8
ЯРУС 4 СЕЧЕНИЕ 1									
1	N	0.0	0.0	0.0	0.0	0.3	0.0	0.0	0.0
	MX	-0.4	-0.3	0.5	0.2	0.0	0.1	0.0	-0.3
	QY	0.2	0.1	-0.2	-0.1	0.0	0.0	0.0	0.1
	MU	-0.4	0.5	0.3	0.1	-0.1	-0.1	0.0	0.3
	QX	-0.1	0.0	0.1	0.0	0.0	0.0	0.0	0.1
8	N	0.0	0.0	0.0	0.0	0.5	-0.7	0.0	0.0
	MX	0.3	0.2	0.0	0.0	0.0	0.1	0.0	-0.1
	QY	-0.1	-0.1	0.0	0.0	0.0	0.0	0.0	0.0
	MU	-2.9	-3.3	-2.8	-2.7	-2.6	-5.9	0.0	-2.5
	QX	-0.3	-0.8	-0.6	-0.6	-0.7	-1.3	0.0	-0.3
9	N	0.0	0.0	0.0	0.0	3.0	0.0	0.0	0.0
	MX	0.1	0.1	0.1	0.1	0.1	1.0	0.0	0.8
	QY	0.0	0.0	0.0	0.0	-0.1	-0.6	0.0	-0.5
	MU	0.0	0.0	0.0	0.0	0.0	0.0	0.0	0.0
	QX	0.0	0.0	0.0	0.0	0.0	0.0	0.0	0.0
14	N	49.4	66.8	66.1	85.7	18.5	65.8	0.0	53.6
	MX	0.8	-0.4	1.5	-0.5	-0.9	1.9	0.0	1.1
	QY	-0.5	0.6	-0.9	0.3	0.6	-1.3	0.0	-1.2
	MU	1.0	-2.3	-0.1	0.0	0.0	1.5	0.0	-0.1
	QX	0.5	-0.7	-0.1	0.0	0.0	0.5	0.0	-0.1
ЯРУС 4 СЕЧЕНИЕ 2									
1	N	0.0	0.0	0.0	0.0	-0.3	0.0	0.0	0.0
	MX	0.1	0.0	0.1	0.0	0.0	0.0	0.0	0.2
	QY	0.1	-0.1	0.2	0.1	0.0	0.0	0.0	-0.1
	MU	-0.1	-0.2	0.1	0.0	0.0	0.0	0.0	0.0
	QX	0.1	0.0	-0.1	0.0	0.0	0.0	0.0	-0.1
8	N	0.0	0.0	0.0	0.0	-0.5	0.7	0.0	0.0
	MX	0.1	0.1	0.0	0.0	0.0	0.0	0.0	0.0
	QY	0.1	0.1	0.0	0.0	0.0	0.0	0.0	0.0
	MU	1.6	0.9	0.9	0.9	0.4	0.8	0.0	1.5
	QX	0.3	0.8	0.6	0.6	0.7	1.3	0.0	0.3
9	N	0.0	0.0	0.0	0.0	-3.0	0.0	0.0	0.0
	MX	0.0	0.0	0.0	0.0	0.1	0.9	0.0	1.0
	QY	0.0	0.0	0.0	0.0	0.1	0.6	0.0	0.5
	MU	0.0	0.0	0.0	0.0	0.0	0.0	0.0	0.0
	QX	0.0	0.0	0.0	0.0	0.0	0.0	0.0	0.0
14	N	-49.4	-66.8	-66.1	-85.7	-18.5	-65.8	0.0	-53.6
	MX	0.9	-1.4	1.6	-1.7	-1.0	2.5	0.0	2.9
	QY	0.5	-0.6	0.9	-0.6	-0.6	1.3	0.0	1.2
	MU	0.7	2.3	-0.1	0.0	0.0	0.5	0.0	-0.1
	QX	-0.5	0.7	0.1	0.0	0.0	0.5	0.0	0.1

1.220.1-3М.0-1.4 19МУ4

ЛИСТ

4

23171-04 21

ФОРМАТ А4

Номер загрузки	Тип усилия	Номер группы элементов							
		1	2	3	4	5	6	7	8
ЯРУС 1 СЕЧЕНИЕ 1									
1	N	0.0	0.0	0.0	0.0	-23.8	-23.8	0.0	0.0
	MX	-5.9	-4.9	-8.4	0.0	-28.3	-10.1	-3.3	0.0
	QU	1.7	1.3	2.1	0.0	22.0	2.4	0.7	0.0
	MU	5.8	8.4	4.8	0.0	10.1	28.3	3.3	0.0
	QX	1.7	2.1	1.3	0.0	-2.3	22.0	0.7	0.0
8	N	0.0	0.0	0.0	0.0	-0.3	-18.3	0.0	0.0
	MX	-0.1	0.1	0.1	0.0	-0.1	0.1	0.1	0.0
	QU	0.0	0.0	0.0	0.0	0.1	0.0	0.0	0.0
	MU	2.7	4.6	3.5	0.0	1.4	-7.4	-1.0	0.0
	QX	1.4	2.0	1.6	0.0	1.7	-5.6	-0.2	0.0
9	N	0.0	0.0	0.0	0.0	-18.3	-0.3	0.0	0.0
	MX	-2.7	-3.5	-4.6	0.0	7.4	-1.4	1.0	0.0
	QU	1.4	1.6	2.0	0.0	-5.7	1.7	-0.2	0.0
	MU	-0.1	-0.1	-0.1	0.0	-0.1	0.1	-0.1	0.0
	QX	0.0	0.0	0.0	0.0	0.0	0.0	0.0	0.0
14	N	83.2	104.6	150.8	0.0	98.2	133.8	82.4	0.0
	MX	0.6	0.0	2.4	0.0	-0.5	1.9	0.0	0.0
	QU	-0.6	0.0	-1.8	0.0	0.4	-1.8	0.0	0.0
	MU	-0.7	-0.1	-0.1	0.0	0.7	0.0	0.0	0.0
	QX	-0.6	1.0	0.0	0.0	-1.1	0.2	0.0	0.0
ЯРУС 1 СЕЧЕНИЕ 2									
1	N	0.0	0.0	0.0	0.0	23.8	23.8	0.0	0.0
	MX	1.7	1.6	3.1	0.0	-26.7	-4.1	1.6	0.0
	QU	-1.7	-1.3	-2.1	0.0	-22.0	2.4	-0.7	0.0
	MU	-1.7	-3.1	-1.6	0.0	4.1	26.6	-1.6	0.0
	QX	-1.7	-2.1	-1.3	0.0	2.3	22.0	-0.7	0.0
8	N	0.0	0.0	0.0	0.0	0.3	18.3	0.0	0.0
	MX	0.0	0.0	0.0	0.0	-0.1	0.0	0.0	0.0
	QU	0.0	0.0	0.0	0.0	-0.1	0.0	0.0	0.0
	MU	0.9	0.5	0.5	0.0	3.0	-6.7	0.5	0.0
	QX	-1.3	-2.0	-1.6	0.0	-1.7	5.6	0.2	0.0
9	N	0.0	0.0	0.0	0.0	18.3	0.3	0.0	0.0
	MX	-0.9	-0.5	-0.5	0.0	6.7	-3.0	-0.5	0.0
	QU	-1.4	-1.6	-2.0	0.0	5.7	-1.7	0.2	0.0
	MU	0.0	0.0	0.0	0.0	0.0	0.1	0.0	0.0
	QX	0.0	0.0	0.0	0.0	0.0	-0.1	0.0	0.0
14	N	-83.2	-104.6	-150.8	0.0	-98.2	-133.8	-82.4	0.0
	MX	0.9	0.0	2.1	0.0	-0.5	2.7	0.0	0.0
	QU	0.6	0.0	1.8	0.0	-0.4	1.8	0.0	0.0
	MU	-1.5	-2.6	0.0	0.0	-2.1	0.4	0.0	0.0
	QX	-0.9	1.0	0.0	0.0	1.1	0.1	0.0	0.0

1.220.1-3М.0-1.4, 20МУ1

ГИП	Егунов		СТАДИЯ	ЛИСТ	ЛИСТОВ
И.КОНТР.	Бойко		Р	1	3
РУК.ГР.	Рудавин		ГОСГРАЖДАНСТРОЙ КиевЗНИИЭП		
ПРОВЕРИЛ	Футормя				
РАЗРАБ	Зуежко				
ЗДАНИЕ			ОТ 4.4.30-ЗАЛ(24)4С-2.5		

Номер загрузки	Тип усилия	Номер группы элементов							
		1	2	3	4	5	6	7	8
ЯРУС 2 СЕЧЕНИЕ 1									
1	N	0.0	0.0	0.0	0.0	-5.6	-5.6	0.0	0.0
	MX	-1.7	-1.6	-3.1	0.0	0.3	1.4	-1.6	0.0
	QU	1.7	1.3	2.1	0.0	-0.2	-1.1	0.7	0.0
	MU	1.7	3.1	1.6	0.0	-1.4	-0.3	1.6	0.0
	QX	1.7	2.1	1.3	0.0	-1.0	0.2	0.7	0.0
8	N	0.0	0.0	0.0	0.0	0.3	-9.0	0.0	0.0
	MX	0.0	0.0	0.0	0.0	0.0	0.0	0.0	0.0
	QU	0.0	0.0	0.0	0.0	0.0	0.0	0.0	0.0
	MU	-0.9	-0.5	-0.5	0.0	0.2	0.5	-0.5	0.0
	QX	1.3	2.0	1.6	0.0	0.8	0.5	-0.2	0.0
9	N	0.0	0.0	0.0	0.0	-9.0	0.3	0.0	0.0
	MX	0.9	0.5	0.5	0.0	-0.5	-0.2	0.5	0.0
	QU	1.4	1.6	2.0	0.0	0.5	0.8	-0.2	0.0
	MU	0.0	0.0	0.0	0.0	0.0	0.0	0.0	0.0
	QX	0.0	0.0	0.0	0.0	0.0	0.0	0.0	0.0
14	N	55.7	70.7	118.1	0.0	48.3	78.5	44.1	0.0
	MX	-0.5	-0.0	-1.1	0.0	-0.3	-0.7	0.0	0.0
	QU	0.6	0.0	1.8	0.0	0.5	0.8	0.0	0.0
	MU	1.0	1.5	0.0	0.0	0.7	0.3	0.0	0.0
	QX	0.8	-1.0	0.0	0.0	-0.5	0.6	0.0	0.0
ЯРУС 2 СЕЧЕНИЕ 2									
1	N	0.0	0.0	0.0	0.0	5.6	5.6	0.0	0.0
	MX	-2.4	-1.4	-1.9	0.0	0.3	1.1	0.0	0.0
	QU	-1.6	-1.3	-2.1	0.0	0.2	1.1	-0.6	0.0
	MU	2.4	-1.9	1.4	0.0	-1.1	-0.3	0.0	0.0
	QX	1.7	-2.1	-1.3	0.0	-1.1	-0.2	0.0	0.0
8	N	0.0	0.0	0.0	0.0	-0.3	9.0	0.0	0.0
	MX	0.0	0.0	0.0	0.0	0.0	0.0	0.0	0.0
	QU	0.0	0.0	0.0	0.0	0.0	0.0	0.0	0.0
	MU	4.2	5.4	4.3	0.0	1.8	0.7	0.0	0.0
	QX	-1.4	-2.0	-1.6	0.0	-0.8	-0.5	0.2	0.0
9	N	0.0	0.0	0.0	0.0	9.0	-0.3	0.0	0.0
	MX	-4.2	-4.3	-5.4	0.0	-0.7	-1.8	0.0	0.0
	QU	-1.4	-1.6	-2.0	0.0	-0.5	-0.8	0.2	0.0
	MU	0.0	0.0	0.0	0.0	0.0	0.0	0.0	0.0
	QX	0.0	0.0	0.0	0.0	0.0	0.0	0.0	0.0
14	N	-55.7	-70.7	-118.1	0.0	-48.3	-78.5	-44.1	0.0
	MX	0.8	0.0	3.2	0.0	-0.9	-1.3	0.0	0.0
	QU	0.6	0.0	1.8	0.0	-0.5	-0.8	0.0	0.0
	MU	-1.1	-0.9	-0.1	0.0	-0.5	1.2	0.0	0.0
	QX	0.8	-1.0	0.0	0.0	0.5	-0.6	0.0	0.0

ИНВ № ПОДП
ПОДПИСЬ И ДАТА
ВЗАМ ИНВ №

Безудора
Без
ОПЕРАТОР СИСТЕМЫ
САПР
КиевЗНИИЭП

1.220.1-3М.0-1.4, 20МУ1	ЛИСТ
	2

Номер загрузки	Тип усилия	Номер группы элементов							
		1	2	3	4	5	6	7	8
ЯРУС 3 СЕЧЕНИЕ 1									
1	N	0.0	0.0	0.0	0.0	0.0	0.0	0.0	0.0
	MX	2.4	1.4	1.9	0.0	0.3	-1.6	0.0	0.0
	MY	-0.9	-0.5	-0.3	0.0	-0.1	0.2	0.0	0.0
	QX	-2.4	1.9	-1.4	0.0	1.6	0.3	0.0	0.0
8	N	0.0	0.0	0.0	0.0	0.0	-1.3	0.0	0.0
	MX	0.0	0.0	0.0	0.0	0.1	0.0	0.0	0.0
	MY	0.0	0.0	0.0	0.0	0.0	0.0	0.0	0.0
	QX	-4.2	-5.4	-4.3	0.0	-7.2	-9.2	0.0	0.0
9	N	0.0	0.0	0.0	0.0	-1.3	0.0	0.0	0.0
	MX	4.2	4.3	5.4	0.0	9.2	7.2	0.0	0.0
	MY	-0.4	-0.4	-1.2	0.0	-2.3	-1.5	0.0	0.0
	QX	0.0	0.0	0.0	0.0	0.0	-0.1	0.0	0.0
14	N	33.1	38.4	87.0	0.0	38.3	86.6	0.0	0.0
	MX	0.0	0.0	-1.3	0.0	-0.8	-1.9	0.0	0.0
	MY	0.3	0.0	1.2	0.0	0.3	1.3	0.0	0.0
	QX	0.9	2.2	0.1	0.0	2.3	1.2	0.0	0.0
ЯРУС 3 СЕЧЕНИЕ 2									
1	N	0.0	0.0	0.0	0.0	0.0	0.0	0.0	0.0
	MX	0.7	0.1	-0.9	0.0	0.2	0.8	0.0	0.0
	MY	0.9	0.5	0.3	0.0	0.1	-0.2	0.0	0.0
	QX	-0.7	-0.9	-0.1	0.0	-0.8	-0.2	0.0	0.0
8	N	0.0	0.0	0.0	0.0	0.0	1.3	0.0	0.0
	MX	0.0	0.0	0.0	0.0	0.0	0.0	0.0	0.0
	MY	0.0	0.0	0.0	0.0	0.0	0.0	0.0	0.0
	QX	2.9	1.5	2.9	0.0	2.4	1.5	0.0	0.0
9	N	0.0	0.0	0.0	0.0	1.3	0.0	0.0	0.0
	MX	-2.9	-2.9	-1.5	0.0	-1.5	-2.4	0.0	0.0
	MY	0.4	0.4	1.1	0.0	2.3	1.4	0.0	0.0
	QX	0.0	0.0	0.0	0.0	0.0	0.0	0.0	0.0
14	N	-33.1	-38.4	-87.0	0.0	-38.3	-86.6	0.0	0.0
	MX	-0.9	0.0	2.8	0.0	-0.2	2.5	0.0	0.0
	MY	-0.3	0.0	1.2	0.0	-0.3	1.3	0.0	0.0
	QX	-0.6	-2.4	-0.1	0.0	-2.3	0.4	0.0	0.0

1.220.1-3М.0-1.4 20МУ1

ЛИСТ
3

ФОРМАТ А4

Номер загрузки	Тип усилия	Номер группы элементов							
		1	2	3	4	5	6	7	8
ЯРУС 1 СЕЧЕНИЕ 1									
1	N	0.0	0.0	0.0	0.0	-21.7	-21.7	0.0	0.0
	MX	-3.7	-3.2	-5.9	0.0	-14.3	-6.2	-2.3	0.0
	MY	0.8	0.6	1.1	0.0	7.2	1.2	0.4	0.0
	QX	3.7	5.9	3.2	0.0	6.2	14.3	2.3	0.0
8	N	0.0	0.0	0.0	0.0	-0.2	-18.6	0.0	0.0
	MX	0.0	0.0	0.1	0.0	-0.1	0.1	0.0	0.0
	MY	0.0	0.0	0.0	0.0	0.0	0.0	0.0	0.0
	QX	1.5	2.9	1.7	0.0	0.8	-10.3	-2.0	0.0
9	N	0.0	0.0	0.0	0.0	-18.7	-0.2	0.0	0.0
	MX	-1.6	-1.8	-2.9	0.0	10.3	-0.8	-2.0	0.0
	MY	0.8	0.9	1.2	0.0	-4.9	1.2	-0.3	0.0
	QX	0.0	0.0	-0.1	0.0	-0.1	0.1	0.0	0.0
14	N	83.2	104.6	150.8	0.0	92.3	126.2	82.4	0.0
	MX	-0.8	0.0	-3.0	0.0	-0.3	-2.5	0.0	0.0
	MY	0.4	0.0	1.4	0.0	0.2	1.5	0.0	0.0
	QX	-1.1	1.0	0.1	0.0	1.4	0.0	0.0	0.0
ЯРУС 1 СЕЧЕНИЕ 2									
1	N	0.0	0.0	0.0	0.0	21.7	21.7	0.0	0.0
	MX	0.4	0.6	1.4	0.0	-14.3	1.5	0.9	0.0
	MY	-0.8	-0.6	-1.1	0.0	-7.2	-1.1	-0.4	0.0
	QX	-0.4	-1.4	-0.6	0.0	-1.5	14.3	-0.9	0.0
8	N	0.0	0.0	0.0	0.0	0.2	18.6	0.0	0.0
	MX	0.0	0.0	0.0	0.0	-0.1	0.0	0.0	0.0
	MY	0.0	0.0	0.0	0.0	0.0	0.0	0.0	0.0
	QX	1.7	2.0	1.7	0.0	4.1	-9.4	0.7	0.0
9	N	0.0	0.0	0.0	0.0	18.7	0.2	0.0	0.0
	MX	-1.7	-1.7	-2.0	0.0	9.4	-4.1	-0.7	0.0
	MY	-0.8	-0.9	-1.2	0.0	4.9	-1.2	0.3	0.0
	QX	0.0	0.0	0.0	0.0	0.0	0.1	0.0	0.0
14	N	-83.2	-104.6	-150.8	0.0	-92.3	-126.2	-82.4	0.0
	MX	1.0	0.0	2.8	0.0	-0.4	3.4	0.0	0.0
	MY	0.4	0.0	1.4	0.0	-0.2	1.5	0.0	0.0
	QX	-1.7	-2.7	0.0	0.0	-2.4	0.2	0.0	0.0

Безуглова
ОПЕРАТОР СИСТЕМЫ
САПР
КиевЗНИИЭП

ИНВ № ПОДЛ
ПОДПИСЬ И ДАТА
ВЗАМ ИНВ №

1.220.1-3М.0-1.4 20МУ2

ГИП Егузов
И КОНТР. Бойко
РУК.ГР. Рудавин
ПРОВЕРИЛ Футорная
РАЗРАБ Зуенко

ЗДАНИЕ
3Т 4.4.30-ЗАЛ(24)40-4.0

СТАДИЯ ЛИСТ ЛИСТОВ
Р 1 3
ГОСГРАЖДАНСТРОЙ
КиевЗНИИЭП

23171-04 23

ФОРМАТ А4

Номер загрузки	Тип усилия	Номер группы элементов							
		1	2	3	4	5	6	7	8
ЯРУС 2 СЕЧЕНИЕ 1									
1	N	0.0	0.0	0.0	0.0	1.3	1.3	0.0	0.0
	MX	-0.4	-0.6	-1.4	0.0	0.3	0.6	-0.9	0.0
	QY	0.8	0.6	1.1	0.0	-0.2	-0.5	0.4	0.0
	MU	0.4	1.4	0.6	0.0	-0.6	-0.3	0.9	0.0
	QX	0.8	1.1	0.6	0.0	-0.5	-0.1	0.4	0.0
8	N	0.0	0.0	0.0	0.0	0.2	-7.6	0.0	0.0
	MX	0.0	0.0	0.0	0.0	0.0	0.0	0.0	0.0
	QY	-0.0	0.0	0.0	0.0	0.0	0.0	0.0	0.0
	MU	-1.7	-2.0	-1.7	0.0	-0.1	0.9	-0.7	0.0
	QX	0.8	1.2	0.9	0.0	0.6	0.8	-0.3	0.0
9	N	0.0	0.0	0.0	0.0	-7.6	0.2	0.0	0.0
	MX	1.7	1.7	2.0	0.0	-0.9	0.1	0.7	0.0
	QY	0.8	0.9	1.2	0.0	0.8	0.6	-0.3	0.0
	MU	0.0	0.0	0.0	0.0	0.0	0.0	0.0	0.0
	QX	0.0	0.0	0.0	0.0	0.0	0.0	0.0	0.0
14	N	55.7	70.7	118.1	0.0	47.6	77.5	44.1	0.0
	MX	-0.4	0.0	-0.5	0.0	-0.4	-0.5	0.0	0.0
	QY	0.4	0.0	1.4	0.0	0.5	0.7	0.0	0.0
	MU	0.8	1.4	0.0	0.0	0.6	0.4	0.0	0.0
	QX	0.7	0.9	0.0	0.0	-0.4	0.7	0.0	0.0
ЯРУС 2 СЕЧЕНИЕ 2									
8	N	0.0	0.0	0.0	0.0	-1.3	-1.3	0.0	0.0
	MX	-1.6	-0.9	-1.3	0.0	0.2	0.6	0.0	0.0
	QY	-0.8	-0.6	-1.1	0.0	0.2	0.5	-0.4	0.0
	MU	1.6	1.3	0.9	0.0	-0.6	-0.2	0.0	0.0
	QX	0.8	-1.1	-0.6	0.0	0.5	0.1	0.0	0.0
8	N	0.0	0.0	0.0	0.0	-0.2	7.6	0.0	0.0
	MX	0.0	0.0	0.0	0.0	0.0	0.0	0.0	0.0
	QY	0.0	0.0	0.0	0.0	0.0	0.0	0.0	0.0
	MU	3.7	4.9	2.7	0.0	1.6	1.1	0.0	0.0
	QX	-0.8	-1.2	-0.9	0.0	-0.6	-0.8	0.3	0.0
9	N	0.0	0.0	0.0	0.0	7.6	-0.2	0.0	0.0
	MX	-3.7	-3.7	-4.9	0.0	-1.1	-1.6	0.0	0.0
	QY	-0.6	-0.9	-1.2	0.0	-0.6	-0.6	0.3	0.0
	MU	0.0	0.0	0.0	0.0	0.0	0.0	0.0	0.0
	QX	0.0	0.0	0.0	0.0	0.0	0.0	0.0	0.0
14	N	-55.7	-70.7	-118.1	0.0	-47.6	-77.5	-44.1	0.0
	MX	0.7	0.0	3.0	0.0	-0.9	-1.1	0.0	0.0
	QY	0.4	0.0	1.4	0.0	-0.5	-0.7	0.0	0.0
	MU	-0.9	-0.8	0.0	0.0	0.5	1.3	0.0	0.0
	QX	-0.7	-0.9	0.0	0.0	0.4	-0.7	0.0	0.0

1.220.1-3М.0-1.4 20МУ2

ЛИСТ
2

ФОРМАТ А4

Номер загрузки	Тип усилия	Номер группы элементов							
		1	2	3	4	5	6	7	8
ЯРУС 3 СЕЧЕНИЕ 1									
1	N	0.0	0.0	0.0	0.0	0.0	0.0	0.0	0.0
	MX	1.6	0.9	1.3	0.0	0.3	-1.3	0.0	0.0
	QY	-0.6	-0.3	-0.2	0.0	-0.1	0.2	0.0	0.0
	MU	-1.6	-1.3	-0.9	0.0	1.3	-0.3	0.0	0.0
	QX	0.6	-0.2	-0.3	0.0	0.2	-0.1	0.0	0.0
8	N	0.0	0.0	0.0	0.0	0.0	-1.4	0.0	0.0
	MX	0.0	0.0	0.0	0.0	0.0	0.0	0.0	0.0
	QY	0.0	0.0	0.0	0.0	0.0	0.0	0.0	0.0
	MU	-3.7	-4.9	-3.7	0.0	-7.1	-10.0	0.0	0.0
	QX	-0.2	-1.2	-0.2	0.0	-1.4	-2.6	0.0	0.0
9	N	0.0	0.0	0.0	0.0	-1.4	0.0	0.0	0.0
	MX	3.7	3.7	4.9	0.0	10.0	7.1	0.0	0.0
	QY	-0.2	-0.2	-1.2	0.0	-2.6	-1.5	0.0	0.0
	MU	0.0	0.0	0.0	0.0	0.0	0.0	0.0	0.0
	QX	0.0	0.0	0.0	0.0	0.0	0.0	0.0	0.0
14	N	33.1	38.4	87.0	0.0	38.3	0.0	0.0	0.0
	MX	-0.1	0.0	-1.0	0.0	-0.9	0.0	0.0	0.0
	QY	-0.2	0.0	1.2	0.0	0.3	1.3	0.0	0.0
	MU	1.0	2.3	0.0	0.0	2.4	1.3	0.0	0.0
	QX	0.5	1.4	0.0	0.0	1.4	0.5	0.0	0.0
ЯРУС 3 СЕЧЕНИЕ 2									
1	N	0.0	0.0	0.0	0.0	0.0	0.0	0.0	0.0
	MX	0.4	0.1	-0.6	0.0	0.1	0.6	0.0	0.0
	QY	0.6	0.3	0.2	0.0	0.1	-0.2	0.0	0.0
	MU	-0.4	0.6	-0.1	0.0	-0.6	-0.1	0.0	0.0
	QX	-0.6	0.2	0.3	0.0	-0.2	0.1	0.0	0.0
8	N	0.0	0.0	0.0	0.0	0.0	1.4	0.0	0.0
	MX	0.0	0.0	0.0	0.0	0.0	0.0	0.0	0.0
	QY	0.0	0.0	0.0	0.0	0.0	0.0	0.0	0.0
	MU	3.0	1.3	3.0	0.0	2.4	1.3	0.0	0.0
	QX	0.2	1.0	0.2	0.0	1.5	2.6	0.0	0.0
9	N	0.0	0.0	0.0	0.0	1.4	0.0	0.0	0.0
	MX	-3.0	-3.0	-1.3	0.0	-1.3	-2.4	0.0	0.0
	QY	0.2	0.2	1.0	0.0	2.6	1.4	0.0	0.0
	MU	0.0	0.0	0.0	0.0	0.0	0.0	0.0	0.0
	QX	0.0	0.0	0.0	0.0	0.0	0.0	0.0	0.0
14	N	-33.1	-38.4	-87.0	0.0	-38.3	-86.6	0.0	0.0
	MX	0.9	0.0	3.0	0.0	-0.3	2.5	0.0	0.0
	QY	0.2	0.0	1.2	0.0	-0.3	1.3	0.0	0.0
	MU	-0.7	-2.3	-0.1	0.0	-2.3	0.4	0.0	0.0
	QX	-0.7	1.4	0.0	0.0	1.4	-0.5	0.0	0.0

1.220.1-3М.0-1.4 20МУ2

ЛИСТ
3

23171-04 24 ФОРМАТ А4

САПР КИАЗНИИЭЗ

САПР КИАЗНИИЭЗ
ОПЕРАТОР СИСТЕМЫ
Безупрочно
Всё!

ИНВ № ПОДЛ ПОДПИСЬ И ДАТА ВЗАМ ИНВ №

Номер загрузки	Тип усилия	Номер группы элементов							
		1	2	3	4	5	6	7	8
ЯРУС 1 СЕЧЕНИЕ 1									
1	N	0.0	0.0	0.0	0.0	-32.9	-32.9	0.0	0.0
	MX	-6.0	-4.9	-9.5	0.0	-29.6	-12.7	-4.7	0.0
	QY	1.7	1.3	2.5	0.0	23.2	4.3	1.3	0.0
	MU	5.9	9.4	4.9	0.0	12.6	29.6	4.7	0.0
	QX	1.7	2.5	1.3	0.0	-4.2	23.1	1.3	0.0
8	N	0.0	0.0	0.0	0.0	0.1	25.9	0.0	0.0
	MX	0.0	0.0	-0.1	0.0	0.1	-0.1	-0.1	0.0
	QY	0.0	0.0	0.0	0.0	-0.1	0.1	0.0	0.0
	MU	-1.2	-1.9	-1.7	0.0	-0.8	-5.4	-0.5	0.0
	QX	-0.5	-0.7	-0.6	0.0	-0.2	-4.4	-0.1	0.0
9	N	0.0	0.0	0.0	0.0	25.9	0.1	0.0	0.0
	MX	1.3	1.7	2.0	0.0	5.4	0.8	0.5	0.0
	QY	-0.5	-0.6	-0.7	0.0	-4.4	-0.2	-0.1	0.0
	MU	0.0	0.1	0.0	0.0	0.1	-0.1	0.1	0.0
	QX	0.0	0.0	0.0	0.0	0.0	-0.1	0.0	0.0
14	N	105.9	136.9	181.9	0.0	117.9	148.3	126.5	0.0
	MX	-0.2	0.0	-0.2	0.0	-2.6	-0.8	0.0	0.0
	QY	0.4	0.0	-0.8	0.0	2.8	1.0	0.0	0.0
	MU	0.7	1.0	0.1	0.0	1.2	4.3	0.0	0.0
	QX	-0.8	1.4	0.0	0.0	-1.4	4.5	0.0	0.0
ЯРУС 1 СЕЧЕНИЕ 2									
1	N	0.0	0.0	0.0	0.0	32.9	32.9	0.0	0.0
	MX	1.6	1.6	3.1	0.0	-28.4	-1.8	1.6	0.0
	QY	-1.7	-1.3	-2.5	0.0	-23.2	4.3	-1.3	0.0
	MU	-1.6	-3.1	-1.6	0.0	1.9	28.3	-1.6	0.0
	QX	-1.7	-2.5	-1.3	0.0	4.2	23.1	-1.3	0.0
8	N	0.0	0.0	0.0	0.0	-0.1	-25.9	0.0	0.0
	MX	0.0	0.0	0.0	0.0	0.1	0.0	0.0	0.0
	QY	0.0	0.0	0.0	0.0	0.1	-0.1	0.0	0.0
	MU	0.0	0.2	0.2	0.0	0.3	-5.7	0.2	0.0
	QX	0.4	0.7	0.6	0.0	0.2	4.4	0.1	0.0
9	N	0.0	0.0	0.0	0.0	-25.9	-0.1	0.0	0.0
	MX	0.0	-0.2	-0.2	0.0	5.7	-0.3	-0.2	0.0
	QY	0.4	0.6	0.7	0.0	4.4	0.2	0.1	0.0
	MU	0.0	0.0	0.0	0.0	0.0	-0.1	0.0	0.0
	QX	0.0	0.0	0.0	0.0	0.0	0.0	0.0	0.0
14	N	-105.9	-136.9	-181.9	0.0	-117.9	-148.3	-126.5	0.0
	MX	0.8	0.0	2.1	0.0	-4.4	1.7	0.0	0.0
	QY	0.4	0.0	0.8	0.0	-2.8	1.0	0.0	0.0
	MU	-1.5	-2.6	0.0	0.0	-2.3	7.2	0.0	0.0
	QX	-0.8	-1.4	0.0	0.0	1.4	4.5	0.0	0.0

1.220.1-3М.0-1.4 20МУЗ			
ГИП	Егунов		
Н КОНТР.	Бойко		
РУК.ГР.	Рудавин		
ПРОВЕРИЛ	Футорная		
РАЗРАБ	Зуенко		
ЗДАНИЕ		СТАДИЯ	ЛИСТ
Т 4.4.30-ЗАЛ(24)40-2.5		Р	1
КиевЗНИИЭП		ЛИСТОВ	4

ФОРМАТ А4

Номер загрузки	Тип усилия	Номер группы элементов							
		1	2	3	4	5	6	7	8
ЯРУС 2 СЕЧЕНИЕ 1									
1	N	0.0	0.0	0.0	0.0	-12.4	-12.4	0.0	1.3
	MX	-1.6	-1.6	-3.1	0.0	0.4	1.8	-1.6	1.3
	QY	1.7	1.3	2.5	0.0	-0.3	-2.0	1.3	1.3
	MU	1.6	3.1	1.6	0.0	-1.8	-0.4	1.6	1.3
	QX	1.7	2.5	1.3	0.0	2.0	0.3	1.3	1.3
8	N	0.0	0.0	0.0	0.0	-0.2	-12.5	0.0	-0.1
	MX	0.0	0.0	0.0	0.0	0.0	0.0	0.0	-0.1
	QY	0.0	0.0	0.0	0.0	0.0	0.0	0.0	-0.1
	MU	0.0	-0.2	-0.2	0.0	-0.2	-0.4	-0.2	-0.1
	QX	-0.4	-0.7	-0.6	0.0	-0.1	-0.2	-0.1	-0.1
9	N	0.0	0.0	0.0	0.0	-12.5	-0.2	0.0	0.0
	MX	0.0	0.2	0.2	0.0	0.4	0.2	0.2	0.0
	QY	-0.4	-0.6	-0.7	0.0	-0.2	-0.1	-0.1	0.0
	MU	0.0	0.0	0.0	0.0	0.0	0.0	0.0	0.0
	QX	0.0	0.0	0.0	0.0	0.0	0.0	0.0	0.0
14	N	78.3	102.9	149.1	0.0	51.3	71.5	88.2	0.0
	MX	-0.6	0.0	-1.2	0.0	-0.3	0.5	0.0	0.0
	QY	0.4	0.0	0.8	0.0	0.0	-0.3	0.0	0.0
	MU	1.0	1.5	0.0	0.0	-0.6	0.6	0.0	0.0
	QX	0.9	1.4	0.0	0.0	0.5	-0.2	0.0	0.0
ЯРУС 2 СЕЧЕНИЕ 2									
1	N	0.0	0.0	0.0	0.0	12.4	12.4	0.0	-1.3
	MX	-2.5	-1.6	-3.0	0.0	0.3	2.9	-1.4	-1.3
	QY	-1.7	-1.3	-2.5	0.0	0.3	2.0	-1.3	-1.3
	MU	2.4	2.9	1.5	0.0	-2.9	-0.3	1.4	-1.3
	QX	-1.7	-2.5	-1.3	0.0	-2.0	-0.3	-1.3	-1.3
8	N	0.0	0.0	0.0	0.0	0.2	12.5	0.0	0.1
	MX	0.0	0.0	-0.1	0.0	0.0	-0.1	-0.1	0.1
	QY	0.0	0.0	0.0	0.0	0.0	0.0	0.0	0.1
	MU	-1.2	-1.4	-1.2	0.0	-0.2	-0.2	0.0	0.1
	QX	0.5	0.7	0.6	0.0	0.1	0.2	0.1	0.1
9	N	0.0	0.0	0.0	0.0	12.5	0.2	0.0	0.0
	MX	1.2	1.2	1.4	0.0	0.2	0.2	0.0	0.0
	QY	0.5	0.6	0.7	0.0	0.2	0.1	0.1	0.0
	MU	0.0	0.1	0.0	0.0	0.1	0.0	0.1	0.0
	QX	0.0	0.0	0.0	0.0	0.0	0.0	0.0	0.0
14	N	-78.3	-102.9	-149.1	0.0	-51.3	-71.5	-88.2	0.0
	MX	-0.4	0.0	-0.6	0.0	-0.2	0.4	0.0	0.0
	QY	-0.4	0.0	-0.8	0.0	0.0	0.3	0.0	0.0
	MU	1.1	1.9	0.0	0.0	-0.6	0.2	0.0	0.0
	QX	0.8	-1.4	0.0	0.0	0.5	0.2	0.0	0.0

Безуглова
 ОПЕРАТОР СИСТЕМЫ
 САПР КиевЗНИИЭП

ВЗАМ ИНВ №
 ПОДПИСЬ И ДАТА
 ИНВ № ПОДЛ

1.220.1-3М.0-1.4 20МУЗ		ЛИСТ
23171-04 25		2

ФОРМАТ А4

Номер загрузки	Тип усилия	Номер группы элементов							
		1	2	3	4	5	6	7	8
ЯРУС 3 СЕЧЕНИЕ 1									
1	N	0.0	0.0	0.0	0.0	-3.0	-3.0	0.0	0.0
	MX	2.5	1.6	3.0	0.0	0.2	-2.2	1.4	0.0
	QY	-0.9	-0.6	-1.0	0.0	-0.1	1.0	-0.4	0.0
	MU	-2.4	-2.9	-1.5	0.0	2.2	-0.2	-1.4	0.0
	QX	-0.9	-1.0	-0.6	0.0	-1.0	0.1	-0.4	0.0
8	N	0.0	0.0	0.0	0.0	-0.4	-10.5	0.0	0.0
	MX	0.0	0.0	0.1	0.0	0.0	0.1	0.1	0.0
	QY	0.0	0.0	0.0	0.0	0.0	0.0	0.0	0.0
	MU	1.2	1.4	1.2	0.0	0.8	0.1	0.0	0.0
	QX	1.7	2.1	1.7	0.0	0.8	0.1	0.0	0.0
9	N	0.0	0.0	0.0	0.0	-10.5	0.4	0.0	0.0
	MX	-1.2	-1.2	-1.4	0.0	-0.1	-0.8	0.0	0.0
	QY	1.7	1.7	2.1	0.0	0.1	0.8	0.0	0.0
	MU	0.0	-0.1	0.0	0.0	-0.1	0.0	-0.1	0.0
	QX	0.0	0.0	0.0	0.0	0.0	0.0	0.0	0.0
14	N	55.7	70.7	118.1	0.0	38.2	63.4	44.1	0.0
	MX	0.4	0.0	1.3	0.0	-0.6	0.6	0.0	0.0
	QY	-0.4	0.0	-1.3	0.0	0.5	-0.5	0.0	0.0
	MU	-0.8	-1.2	0.0	0.0	-0.4	0.8	0.0	0.0
	QX	-0.5	0.6	0.0	0.0	-0.2	-0.7	0.0	0.0
ЯРУС 3 СЕЧЕНИЕ 2									
1	N	0.0	0.0	0.0	0.0	3.0	3.0	0.0	0.0
	MX	-0.6	-0.4	-0.5	0.0	0.2	-0.9	0.0	0.0
	QY	-0.9	-0.6	-1.0	0.0	0.1	-1.0	0.0	0.0
	MU	0.6	-0.5	0.3	0.0	0.9	-0.2	0.0	0.0
	QX	-0.9	-1.0	-0.6	0.0	1.0	-0.1	-0.4	0.0
8	N	0.0	0.0	0.0	0.0	0.4	10.5	0.0	0.0
	MX	-0.1	0.0	0.0	0.0	0.0	0.0	0.0	0.0
	QY	0.0	0.0	0.0	0.0	0.0	0.0	0.0	0.0
	MU	4.5	5.5	4.4	0.0	1.8	0.3	0.0	0.0
	QX	-1.7	-2.1	-1.7	0.0	-0.8	-0.1	0.0	0.0
9	N	0.0	0.0	0.0	0.0	10.5	-0.4	0.0	0.0
	MX	-4.5	-4.4	-5.5	0.0	-0.3	-1.8	0.0	0.0
	QY	-1.7	-1.7	-2.1	0.0	-0.1	-0.8	0.0	0.0
	MU	0.1	0.0	0.0	0.0	0.0	0.0	0.0	0.0
	QX	0.0	0.0	0.0	0.0	0.0	0.0	0.0	0.0
14	N	-55.7	-70.7	-118.1	0.0	-38.2	-63.4	-44.1	0.0
	MX	0.7	0.0	3.1	0.0	-1.0	-1.0	0.0	0.0
	QY	0.4	0.0	1.3	0.0	-0.5	-0.5	0.0	0.0
	MU	-0.9	-0.7	-0.1	0.0	-0.3	1.5	0.0	0.0
	QX	0.5	-0.6	0.0	0.0	0.2	-0.7	0.0	0.0

ЛИСТ

1.220.1-3М.0-1.4 20МУ3

3

ФОРМАТ А4

Номер загрузки	Тип усилия	Номер группы элементов							
		1	2	3	4	5	6	7	8
ЯРУС 4 СЕЧЕНИЕ 1									
1	N	0.0	0.0	0.0	0.0	0.0	0.0	0.0	0.0
	MX	0.6	0.4	0.5	0.0	0.1	0.0	0.0	0.0
	QY	-0.2	-0.1	-0.1	0.0	-0.1	0.0	0.0	0.0
	MU	-0.6	0.5	-0.3	0.0	0.0	-0.1	0.0	0.0
	QX	-0.2	-0.1	-0.1	0.0	0.0	-0.1	0.0	0.0
8	N	0.0	0.0	0.0	0.0	0.0	-1.3	0.0	0.0
	MX	0.1	0.0	0.0	0.0	0.1	0.0	0.0	0.0
	QY	0.0	0.0	0.0	0.0	0.0	0.0	0.0	0.0
	MU	-4.5	-5.5	-4.4	0.0	-7.1	-8.9	0.0	0.0
	QX	-0.5	-1.3	-0.5	0.0	-1.4	-2.2	0.0	0.0
9	N	0.0	0.0	0.0	0.0	-1.3	0.0	0.0	0.0
	MX	4.5	4.4	5.5	0.0	8.9	7.1	0.0	0.0
	QY	-0.5	-0.5	-1.3	0.0	-2.2	-1.5	0.0	0.0
	MU	-0.1	0.0	0.0	0.0	0.0	-0.1	0.0	0.0
	QX	0.0	0.0	0.0	0.0	0.0	0.0	0.0	0.0
14	N	33.1	38.4	87.0	0.0	38.3	86.6	0.0	0.0
	MX	-0.1	0.0	-1.1	0.0	-1.1	-1.9	0.0	0.0
	QY	-0.2	0.0	1.2	0.0	0.4	1.3	0.0	0.0
	MU	1.0	2.3	0.1	0.0	2.4	1.7	0.0	0.0
	QX	-0.5	1.4	0.0	0.0	1.4	-0.7	0.0	0.0
ЯРУС 4 СЕЧЕНИЕ 2									
1	N	0.0	0.0	0.0	0.0	0.0	0.0	0.0	0.0
	MX	0.1	0.0	-0.2	0.0	0.1	0.0	0.0	0.0
	QY	0.2	0.1	0.1	0.0	0.1	0.0	0.0	0.0
	MU	-0.1	-0.2	0.0	0.0	0.0	-0.1	0.0	0.0
	QX	-0.2	0.1	0.1	0.0	0.0	-0.1	0.0	0.0
8	N	0.0	0.0	0.0	0.0	0.0	1.3	0.0	0.0
	MX	0.0	0.0	0.0	0.0	0.0	0.0	0.0	0.0
	QY	0.0	0.0	0.0	0.0	0.0	0.0	0.0	0.0
	MU	2.9	1.6	2.9	0.0	2.4	1.6	0.0	0.0
	QX	0.4	1.1	0.5	0.0	1.5	2.2	0.0	0.0
9	N	0.0	0.0	0.0	0.0	1.3	0.0	0.0	0.0
	MX	-2.9	-2.8	-1.6	0.0	-1.6	-2.4	0.0	0.0
	QY	0.5	0.5	1.1	0.0	2.2	1.4	0.0	0.0
	MU	0.0	0.0	0.0	0.0	0.0	0.0	0.0	0.0
	QX	0.0	0.0	0.0	0.0	0.0	0.0	0.0	0.0
14	N	-33.1	-38.4	-87.0	0.0	-38.3	-86.6	0.0	0.0
	MX	-0.9	0.0	2.9	0.0	-0.3	2.5	0.0	0.0
	QY	-0.3	0.0	1.2	0.0	-0.4	1.3	0.0	0.0
	MU	-0.7	-2.3	0.1	0.0	-2.3	0.5	0.0	0.0
	QX	0.5	1.4	0.0	0.0	1.4	0.6	0.0	0.0

ИНВ № ПОДП

ПОДПИСЬ И ДАТА

ВЗАМ ИНВ №

Безупоно

ОПЕРАТОР СИСТЕМЫ

САПР КиевЗНИИЭП

ЛИСТ

1.220.1-3М.0-1.4 20МУ3

4

23171-04 26

ФОРМАТ А4

Номер загрузки	Тип услия	Номер группы элементов							
		1	2	3	4	5	6	7	8
ЯРУС 1 СЕЧЕНИЕ 1									
1	N	0.0	0.0	0.0	0.0	-23.1	-23.1	0.0	0.0
	MX	-3.7	-3.3	-6.5	0.0	-14.3	-8.3	-3.2	0.0
	QU	0.8	0.7	1.3	0.0	7.2	2.3	0.6	0.0
	MU	3.7	6.5	3.3	0.0	8.3	14.3	3.2	0.0
	QX	0.8	1.3	0.7	0.0	-2.2	7.2	0.6	0.0
8	N	0.0	0.0	0.0	0.0	0.1	27.1	0.0	0.0
	MX	0.0	0.0	-0.1	0.0	0.1	-0.1	-0.1	0.0
	QU	0.0	0.0	0.0	0.0	0.0	0.0	0.0	0.0
	MU	-1.7	-2.8	-2.6	0.0	-2.1	-8.0	-1.6	0.0
	QX	-0.5	-0.7	-0.6	0.0	-0.5	-4.0	-0.3	0.0
9	N	0.0	0.0	0.0	0.0	27.1	0.1	0.0	0.0
	MX	1.7	2.7	2.8	0.0	7.9	2.1	1.6	0.0
	QU	-0.5	-0.6	-0.7	0.0	-4.0	-0.5	-0.3	0.0
	MU	-0.1	0.1	0.0	0.0	0.1	-0.1	0.1	0.0
	QX	0.0	0.0	0.0	0.0	0.0	0.0	0.0	0.0
14	N	105.9	136.9	181.9	0.0	112.8	142.6	126.5	0.0
	MX	-0.5	0.0	-0.7	0.0	-1.3	-1.2	0.0	0.0
	QU	0.3	0.0	0.7	0.0	0.9	0.8	0.0	0.0
	MU	1.1	1.9	0.0	0.0	1.7	2.2	0.0	0.0
	QX	-0.7	1.2	0.0	0.0	1.1	1.5	0.0	0.0
ЯРУС 1 СЕЧЕНИЕ 2									
1	N	0.0	0.0	0.0	0.0	23.1	23.1	0.0	0.0
	MX	0.4	0.6	1.2	0.0	-14.3	-0.8	0.6	0.0
	QU	-0.8	-0.7	-1.3	0.0	-7.2	-2.3	-0.6	0.0
	MU	-0.4	-1.2	-0.6	0.0	0.8	14.3	-0.6	0.0
	QX	-0.8	-1.3	-0.7	0.0	2.2	-7.2	-0.6	0.0
8	N	0.0	0.0	0.0	0.0	-0.1	-27.1	0.0	0.0
	MX	0.0	0.0	0.0	0.0	0.1	-0.1	0.0	0.0
	QU	0.0	0.0	0.0	0.0	0.0	-0.1	0.0	0.0
	MU	-0.2	0.1	0.1	0.0	0.1	-7.9	0.4	0.0
	QX	0.4	0.7	0.6	0.0	0.5	4.0	0.3	0.0
9	N	0.0	0.0	0.0	0.0	-27.1	-0.1	0.0	0.0
	MX	0.2	-0.1	-0.1	0.0	7.9	-0.1	-0.4	0.0
	QU	0.5	0.6	0.7	0.0	4.0	0.5	0.3	0.0
	MU	0.0	0.0	0.0	0.0	0.1	-0.1	0.0	0.0
	QX	0.0	0.0	0.0	0.0	0.0	0.0	0.0	0.0
14	N	-105.9	-136.9	-181.9	0.0	-112.8	-142.6	-126.5	0.0
	MX	0.9	0.0	2.1	0.0	-2.4	-1.9	0.0	0.0
	QU	0.3	0.0	0.7	0.0	-0.9	-0.8	0.0	0.0
	MU	-1.7	-2.9	0.0	0.0	2.7	4.0	0.0	0.0
	QX	-0.7	1.2	0.0	0.0	-1.1	-1.5	0.0	0.0

1.220.1-3М.0-1.4 20МУ4			
ГИП	Егумов	<i>Егумов</i>	
НКОНТР	Бойко	<i>Бойко</i>	
РУК.ГР	Рудавин	<i>Рудавин</i>	
ПРОВЕРИЛ	Футорная	<i>Футорная</i>	
РАЗРАБ	Зуенко	<i>Зуенко</i>	
ЗДАНИЕ			
АТ 4.4.30-ЗАЛ(24)40-4.0			
СТАДИЯ	ЛИСТ	ЛИСТОВ	
Р	1	4	
ГОСГРАЖДАНСТРОЙ			
КиевЗНИИЭП			

ФОРМАТ А4

Номер загрузки	Тип услия	Номер группы элементов							
		1	2	3	4	5	6	7	8
ЯРУС 2 СЕЧЕНИЕ 1									
1	N	0.0	0.0	0.0	0.0	2.8	2.8	0.0	0.6
	MX	-0.4	-0.6	-1.2	0.0	0.2	0.8	-0.6	0.6
	QU	0.8	0.7	1.3	0.0	-0.2	-1.1	0.6	0.6
	MU	0.4	1.2	0.6	0.0	-0.8	-0.2	0.6	0.6
	QX	0.8	1.3	0.7	0.0	-1.1	0.0	0.6	0.6
8	N	0.0	0.0	0.0	0.0	-0.2	-11.3	0.0	-0.3
	MX	0.0	0.0	0.0	0.0	0.0	0.0	0.0	-0.3
	QU	0.0	0.0	0.0	0.0	0.0	0.0	0.0	-0.3
	MU	-0.2	-0.1	-0.1	0.0	-0.3	-0.2	-0.4	-0.3
	QX	-0.4	-0.7	-0.6	0.0	-0.3	-0.1	-0.3	-0.3
9	N	0.0	0.0	0.0	0.0	-11.3	-0.2	0.0	0.0
	MX	-0.2	0.1	0.1	0.0	0.2	0.3	0.4	0.0
	QU	-0.5	-0.6	-0.7	0.0	-0.1	-0.3	-0.3	0.0
	MU	0.3	0.0	0.0	0.0	0.0	0.0	0.0	0.0
	QX	0.0	0.0	0.0	0.0	0.0	0.0	0.0	0.0
14	N	78.3	102.9	149.1	0.0	50.2	70.3	88.2	0.0
	MX	-0.5	0.0	-1.1	0.0	-0.3	0.4	0.0	0.0
	QU	0.3	0.0	0.7	0.0	0.0	-0.3	0.0	0.0
	MU	0.8	1.1	0.0	0.0	-0.5	0.5	0.0	0.0
	QX	0.7	-1.2	0.0	0.0	-0.4	-0.2	0.0	0.0
ЯРУС 2 СЕЧЕНИЕ 2									
1	N	0.0	0.0	0.0	0.0	-2.8	-2.8	0.0	-0.6
	MX	-1.6	-1.0	-1.9	0.0	0.2	1.8	-0.9	-0.6
	QU	-0.8	-0.7	-1.3	0.0	0.2	1.1	-0.6	-0.6
	MU	-1.6	-1.9	-1.0	0.0	-1.8	-0.2	0.9	-0.6
	QX	-0.8	-1.3	-0.7	0.0	1.1	0.0	-0.6	-0.6
8	N	0.0	0.0	0.0	0.0	0.2	11.3	0.0	0.3
	MX	0.0	0.0	-0.1	0.0	0.0	-0.1	-0.1	0.3
	QU	0.0	0.0	0.0	0.0	0.0	0.0	0.0	0.3
	MU	-1.3	-1.6	-1.4	0.0	-0.5	-0.1	-0.3	0.3
	QX	0.5	0.7	0.6	0.0	0.3	0.1	0.3	0.3
9	N	0.0	0.0	0.0	0.0	11.3	0.2	0.0	0.0
	MX	1.3	1.4	1.6	0.0	0.1	0.5	0.3	0.0
	QU	0.5	0.6	0.7	0.0	0.1	0.3	0.3	0.0
	MU	0.0	0.1	0.0	0.0	0.1	0.0	0.1	0.0
	QX	0.0	0.0	0.0	0.0	0.0	0.0	0.0	0.0
14	N	-78.3	-102.9	-149.1	0.0	-50.2	-70.3	-88.2	0.0
	MX	-0.3	0.0	-0.6	0.0	-0.3	-0.3	0.0	0.0
	QU	-0.3	0.0	-0.7	0.0	0.0	-0.3	0.0	0.0
	MU	0.9	1.7	0.0	0.0	0.5	0.2	0.0	0.0
	QX	0.7	-1.2	0.0	0.0	0.4	-0.2	0.0	0.0

Безудова
Белл
ОПЕРАТОР СИСТЕМ
САПР
КиевЗНИИЭП

ИНВ. ПОДЛ. ПОДПИСЬ И ДАТА. ВЗАМ. ИНВ.Н

1.220.1-3М.0-1.4 20МУ4		ЛИСТ
23171-04 27		2

ФОРМАТ А4

Номер загрузки	Тип усилия	Номер группы элементов							
		1	2	3	4	5	6	7	8
ЯРУС 3 СЕЧЕНИЕ 1									
1	N	0.0	0.0	0.0	0.0	1.4	1.4	0.0	0.0
	MX	1.6	1.0	1.9	0.0	0.1	-1.6	0.9	0.0
	QY	-0.6	-0.4	-0.7	0.0	0.0	0.7	-0.3	0.0
	MU	-1.6	-1.9	-1.0	0.0	1.6	-0.1	-0.9	0.0
	QX	-0.6	-0.7	-0.4	0.0	0.7	0.0	-0.3	0.0
8	N	0.0	0.0	0.0	0.0	-0.4	-10.4	0.0	0.0
	MX	0.0	0.0	0.1	0.0	0.0	0.1	0.1	0.0
	QY	0.0	0.0	0.0	0.0	0.0	0.0	0.0	0.0
	MU	1.3	1.6	1.4	0.0	1.0	0.1	0.3	0.0
	QX	1.8	2.1	1.8	0.0	0.9	0.1	0.1	0.0
9	N	0.0	0.0	0.0	0.0	-10.4	0.4	0.0	0.0
	MX	-1.3	-1.4	-1.6	0.0	-0.1	-1.0	-0.3	0.0
	QY	1.8	1.8	2.1	0.0	0.1	0.9	0.1	0.0
	MU	0.0	-0.1	0.0	0.0	-0.1	0.0	-0.1	0.0
	QX	0.0	0.0	0.0	0.0	0.0	0.0	0.0	0.0
14	N	55.7	70.7	118.1	0.0	37.9	63.1	44.1	0.0
	MX	0.5	0.0	1.4	0.0	-0.6	0.7	0.0	0.0
	QY	-0.4	0.0	-1.3	0.0	0.5	-0.5	0.0	0.0
	MU	-1.0	-1.4	0.0	0.0	-0.5	0.8	0.0	0.0
	QX	-0.5	-0.6	0.0	0.0	-0.2	-0.7	0.0	0.0
ЯРУС 3 СЕЧЕНИЕ 2									
	N	0.0	0.0	0.0	0.0	-1.4	-1.4	0.0	0.0
	MX	-0.4	-0.2	-0.3	0.0	0.1	-0.7	0.0	0.0
	QY	-0.6	-0.4	-0.7	0.0	0.0	-0.7	-0.3	0.0
	MU	0.4	0.3	0.2	0.0	0.7	-0.1	0.0	0.0
	QX	0.6	-0.7	-0.4	0.0	0.7	0.0	-0.3	0.0
8	N	0.0	0.0	0.0	0.0	0.4	10.4	0.0	0.0
	MX	-0.1	0.0	0.0	0.0	0.0	0.0	0.0	0.0
	QY	0.0	0.0	0.0	0.0	0.9	0.0	0.0	0.0
	MU	4.5	5.5	4.4	0.0	1.9	0.3	0.0	0.0
	QX	-1.8	-2.1	-1.8	0.0	-0.9	-0.1	-0.1	0.0
9	N	0.0	0.0	0.0	0.0	10.4	-0.4	0.0	0.0
	MX	-4.5	-4.5	-5.5	0.0	-0.3	-1.9	0.0	0.0
	QY	-1.8	-1.8	-2.1	0.0	-0.1	-0.9	-0.1	0.0
	MU	0.1	0.0	-0.1	0.0	0.0	0.0	0.0	0.0
	QX	0.0	0.0	0.0	0.0	0.0	0.0	0.0	0.0
14	N	-55.7	-70.7	-118.1	0.0	-37.9	-63.1	-44.1	0.0
	MX	0.8	0.0	3.1	0.0	-1.1	1.1	0.0	0.0
	QY	0.4	0.0	1.3	0.0	-0.5	0.5	0.0	0.0
	MU	-1.0	-0.8	-0.1	0.0	-0.3	1.5	0.0	0.0
	QX	0.5	-0.6	0.0	0.0	0.2	0.7	0.0	0.0

1.220.1-3М.0-1.4 20МУ4

ЛИСТ
3

ФОРМАТ А4

Номер загрузки	Тип усилия	Номер группы элементов							
		1	2	3	4	5	6	7	8
ЯРУС 4 СЕЧЕНИЕ 1									
1	N	0.0	0.0	0.0	0.0	0.0	0.0	0.0	0.0
	MX	-0.4	0.2	0.3	0.0	0.0	0.0	0.0	0.0
	QY	-0.1	-0.1	0.0	0.0	0.0	0.0	0.0	0.0
	MU	-0.4	-0.3	-0.2	0.0	0.0	0.0	0.0	0.0
	QX	0.1	0.0	-0.1	0.0	0.0	0.0	0.0	0.0
8	N	0.0	0.0	0.0	0.0	0.0	0.0	-1.3	0.0
	MX	0.1	0.0	0.0	0.0	0.1	0.0	0.0	0.0
	QY	0.0	0.0	0.0	0.0	0.0	0.0	0.0	0.0
	MU	-4.5	-5.5	-4.4	0.0	-7.1	-8.9	0.0	0.0
	QX	-0.5	-1.3	-0.5	0.0	-1.4	-2.2	0.0	0.0
9	N	0.0	0.0	0.0	0.0	-1.3	0.0	0.0	0.0
	MX	-4.5	4.5	5.5	0.0	-8.9	7.1	0.0	0.0
	QY	-0.5	-0.5	-1.3	0.0	-2.2	-1.5	0.0	0.0
	MU	-0.1	0.0	0.1	0.0	0.0	-0.1	0.0	0.0
	QX	0.0	0.0	0.0	0.0	0.0	0.0	0.0	0.0
14	N	33.1	38.4	87.0	0.0	38.3	86.6	0.0	0.0
	MX	-0.1	0.0	-1.1	0.0	-1.1	-1.9	0.0	0.0
	QY	-0.2	0.0	1.2	0.0	0.4	1.3	0.0	0.0
	MU	1.0	2.3	0.1	0.0	2.4	1.7	0.0	0.0
	QX	-0.5	1.4	0.0	0.0	1.4	-0.7	0.0	0.0
ЯРУС 4 СЕЧЕНИЕ 2									
1	N	0.0	0.0	0.0	0.0	0.0	0.0	0.0	0.0
	MX	0.1	0.0	-0.2	0.0	0.0	0.0	0.0	0.0
	QY	0.1	0.1	0.0	0.0	0.0	0.0	0.0	0.0
	MU	-0.1	0.2	0.0	0.0	0.0	0.0	0.0	0.0
	QX	-0.1	0.0	0.1	0.0	0.0	0.0	0.0	0.0
8	N	0.0	0.0	0.0	0.0	0.0	0.0	1.3	0.0
	MX	0.0	0.0	0.0	0.0	0.0	0.0	0.0	0.0
	QY	0.0	0.0	0.0	0.0	0.0	0.0	0.0	0.0
	MU	2.9	1.6	2.8	0.0	2.4	1.6	0.0	0.0
	QX	0.4	1.1	0.5	0.0	1.5	2.2	0.0	0.0
9	N	0.0	0.0	0.0	0.0	1.3	0.0	0.0	0.0
	MX	-2.9	-2.8	-1.6	0.0	-1.6	-2.4	0.0	0.0
	QY	0.5	0.5	1.1	0.0	2.2	1.4	0.0	0.0
	MU	0.1	0.0	0.0	0.0	0.0	0.0	0.0	0.0
	QX	0.0	0.0	0.0	0.0	0.0	0.0	0.0	0.0
14	N	-33.1	-38.4	-87.0	0.0	-38.3	-86.6	0.0	0.0
	MX	0.9	0.0	2.9	0.0	-0.3	2.5	0.0	0.0
	QY	0.3	0.0	1.2	0.0	-0.4	1.3	0.0	0.0
	MU	-0.7	-2.3	-0.1	0.0	-2.3	0.5	0.0	0.0
	QX	-0.5	1.4	0.0	0.0	1.4	0.6	0.0	0.0

1.220.1-3М.0-1.4 20МУ4

ЛИСТ
4

23171-04 28

ФОРМАТ А4

Безудово

ОПЕРАТОР СИСТЕМЫ

САПР КИЕВНИИЭП

ИВМ ИВМ

ПОДПИСЬ И ДАТА

МАРКА ПОЗ	ОБОЗНАЧЕНИЕ	НАИМЕНОВАНИЕ	КОЛ	МАССА ЕД. КГ	ПРИМЕЧАНИЕ
		ДОКУМЕНТАЦИЯ			
A3	I.220.I-3M.0-I.4 000	ТЕХНИЧЕСКОЕ ОПИСАНИЕ СБОРОЧНЫЕ ЕДИНИЦЫ РИГЕЛЬ			
P1	I.220.I-3M.3-I 03-02	РДП4.53-50	12	2518	
P2	I.220.I-3M.3-I 01-01	РДП4.53-90АТУ	16	2518	
P10	I.020-I/83.3-I 07-01	РОП 4.57-30	12	2070	
P11	I.020-I/83.3-I 02-02	РДП 4.57-60АТУ	4	2600	
P9	I.220.I-3M.3-I 09	Р4.57-20	28	1710	
P13	I.041.I-2.I.400-01 ПЕРЕМЕННЫЕ ДАННЫЕ	СВЯЗЕВАЯ ПЛИТА ПК56.15-6АТИУС(А1У)Т-2 ДЛЯ ИСПОЛНЕНИЙ I.220.I-3M.0-I.4 2I 3Т 6.4.30-ЗАЛ(2x12) 40-2.5	8	2600	
		РОСТВЕРК			
Ф1	I.220.I-3M.I-I 04-01	Ф3-40	4	3625	
Ф2	I.220.I-3M.I-I 03-01	ИФ3-40	16	3755	
Ф3	I.220.I-3M.I-I 03-01	ИФ3-40	2	3755	
Ф4	I.220.I-3M.I-I 02-01	Ф2-40	4	2575	
Ф5	I.220.I-3M.I-I 03-01	ИФ3-40	1	3755	
Ф6		ИФД9-40	2		
Ф8		ИФД9-40	2		
		КОЛОННА			
K1	I.220.I-3M.2-I 13-01	КОЗТ 3.33-25.3	4	2428	
K2	I.220.I-3M.2-I II-04	КДЗТ 3.33-30.3	6	2496	
K3	I.220.I-3M.2-I I3	КОЗТ 3.33-25.2	2	2373	
K4	I.220.I-3M.2-I I7-02	КОЗТ 3.33-40.7	4	2414	
K5	I.220.I-3M.2-I 09-01	КДИТ 3.33-25.2	4	786	
		I.220.I-3M.0-I.4 2I			
НАЧ.ОТД.	Шевченко	ЗДАНИЕ 3Т 6.4-ЗАЛ(2x12) 4Т 6.4-ЗАЛ(2x12)	СТАДИЯ	ЛИСТ	ЛИСТОВ
И.КОНТР.	Егунов		Р	1	5
ГЛ.СПЕЦ.	Рудакин		ГОСГРАЖДАНСТРОЙ		
ПРОБЕРИЛ	Зуенко		КиевЗНИИЭП		
РАЗРАБ.	Безгудова				

ФОРМАТ А.4

МАРКА ПОЗ	ОБОЗНАЧЕНИЕ	НАИМЕНОВАНИЕ	КОЛ	МАССА ЕД. КГ	ПРИМЕЧАНИЕ
K6	I.220.I-3M.2-I II-04	КДЗТ 3.33-30.3	2	2496	
K7	I.220.I-3M.2-I II-04	КДЗТ 3.33-30.3	2	2496	
K8	I.220.I-3M.2-I I7	КОЗТ 3.33-25.2	2	2320	
K9	I.220.I-3M.2-I I3	КОЗТ 3.33-25.2	2	2373	
K10	I.220.I-3M.2-I I5-06	КДФЗТ 3.33-25.2	3	2396	
K11	I.220.I-3M.2-I II-04	КДЗТ 3.33-30.3	3	2496	
K12	I.220.I-3M.2-I II	КДЗТ 3.33-25.2	1	2441	
		РИГЕЛЬ			
P3	I.020-I/83.3-I 07-02	РОП 4.57-40	24	2070	
P4	I.020-I/83.3-I 02-03	РДП 4.57-70АТУ	20	2600	
		СВЯЗЕВАЯ ПЛИТА			
P11	I.041.I-2.I.200-01	ПК56.12-6АТИУС(А1У)Т-2	12	2000	
P12	I.041.I-2.I.400-02	ПК56.15-6АТИУС(А1У)Т-2 I.220.I-3M.0-I.4 2I-01 3Т 6.4.30-ЗАЛ(2x12) 40-4.0	26	2600	
		РОСТВЕРК			
Ф1	I.220.I-3M.I-I 04-01	Ф3-40	4	3625	
Ф2	I.220.I-3M.I-I 03-01	ИФ3-40	16	3755	
Ф3	I.220.I-3M.I-I 03-01	ИФ3-40	2	3755	
Ф4	I.220.I-3M.I-I 02-01	Ф2-40	4	2575	
Ф5	I.220.I-3M.I-I 03-01	ИФ3-40	1	3755	
Ф6		ИФД9-40	2		
Ф8		ИФД9-40	2		
		КОЛОННА			
K1	I.220.I-3M.2-I I3	КОЗТ 3.33-25.2	4	2373	
K2	I.220.I-3M.2-I II	КДЗТ 3.33-25.2	6	2441	
K3	I.220.I-3M.2-I I3	КОЗТ 3.33-25.2	2	2373	
K4	I.220.I-3M.2-I I7-02	КОЗТ 3.33-40.7	4	2414	
K5	I.220.I-3M.2-I 09-01	КДИТ 3.33-25.2	4	786	
K6	I.220.I-3M.2-I II-01	КДЗТ 3.33-25.3	2	2496	
K7	I.220.I-3M.2-I II	КДЗТ 3.33-25.2	2	2441	
K8	I.220.I-3M.2-I I7	КОЗТ 3.33-25.2	2	2320	
K9	I.220.I-3M.2-I I3	КОЗТ 3.33-25.2	2	2373	
		I.220.I-3M.0-I.4 2I			

САПР
К.ИВАНОВИЧ
ОПЕРАТОР
СИСТЕМ

ИНВ. ПОДП.
ПОДПИСЬ И ДАТА
ВЛАД. ИВАНОВ

23171-04 29

ФОРМАТ А.4

МАРКА ПОЗ	ОБОЗНАЧЕНИЕ	НАИМЕНОВАНИЕ	КОЛ	МАССА ЕД КГ	ПРИМЕЧАНИЕ
РП РП2	I.04I.I-2.I.200-01	СВЯЗЕВАЯ ПЛИТА ПК56.I2-8АТIУС(АIУ)Т-I	20	2000	
	I.04I.I-2.I.400-02	ПК56.I2-8АТIУС(АIУ)Т-2	44	2600	
I.220.I-3M.0-I.4 2I					ЛИСТ 5

ФОРМАТ А4

МАРКА ПОЗ	ОБОЗНАЧЕНИЕ	НАИМЕНОВАНИЕ	КОЛ	МАССА ЕД КГ	ПРИМЕЧАНИЕ
A3	I.220.I-3M.0-I.4 00Т0	ДОКУМЕНТАЦИЯ ТЕХНИЧЕСКОЕ ОПИСАНИЕ СБОРОЧНЫЕ ЕДИНИЦЫ РИТЕЛЬ			
P1	I.220.I-3M.3-I 03-02	РДП4.53-50	5	2518	
P2	I.220.I-3M.3-I 01-01	РДП4.53-90АТУ	11	2518	
P5	I.220.I-3M.3-I 05	РДП4.65-50	2	3090	
P6	I.220.I-3M.3-I 01	РДП4.65-90АТУ	4	3090	
P9	I.220.I-3M.3-I 09	Р4.57-20	18	1710	
P10	I.020-I/83.3-I 07-01	РОП 4.57-30	5	2070	
P11	I.020-I/83.3-I 10	РОП 4.69-30	2	2520	
P12	I.020-I/83.3-I 04-02	РДП 4.69-60АТУ	4	3170	
P13	I.020-I/83.3-I 02-02	РДП 4.57-60АТУ	4	2600	
P13	I.04I.I-2.I.400-01 ПЕРЕМЕННЫЕ ДАННЫЕ	СВЯЗЕВАЯ ПЛИТА ПК56.I5-6АТIУС(АIУ)Т-2 ДЛЯ ИСПОЛНЕНИЯ I.220.I-3M.0-I.4 22 ЗТ 4.5.30-ЗАЛ(12) 32-3.5	7	2600	
Ф1	I.220.I-3M.I-I 04	РОСТВЕРК 2Ф3-32	4	4275	
Ф2	I.220.I-3M.I-I 03	1Ф3-32	8	4390	
Ф3	I.220.I-3M.I-I 02	Ф2-32	3	2650	
Ф4	I.220.I-3M.I-I 03	1Ф3-32	5	4390	
Ф6		ФД9-32	3		
Ф7		1ФД9-32	1		
Ф12		1ФД9-32	1		
KI	I.220.I-3M.2-I 13-04	КОЛОННА КОЗТ 3.33-30.3	4	2428	
I.220.I-3M.0-I.4 22					
ИНВЕН ПОДЛ	ПОДПИСЬ И ДАТА	ВЗАМ ИНВЕН	ЗДАНИЕ ЗТ 4.5-ЗАЛ(12) 4Т 4.5-ЗАЛ(12)		
НАЧ.ОТД	Шевченко	<i>[Signature]</i>			
И.КОНТР.	Егунов	<i>[Signature]</i>			
ГЛ.СПЕЦ.	Рудакин	<i>[Signature]</i>			
ПРОВЕРИЛ	Зуенко	<i>[Signature]</i>			
РАЗРАБ.	Безгудова	<i>[Signature]</i>			
			СТАДИЯ	ЛИСТ	ЛИСТОВ
			Р	1	7
			ГОСГРАЖДАНСТРОЙ		
			КиевЗНИИЭП		

23171-04 31

ФОРМАТ А4

МАРКА ПОЗ	ОБОЗНАЧЕНИЕ	НАИМЕНОВАНИЕ	КОП	МАССА ЕД КГ	ПРИМЕЧАНИЕ
K2	I.220.I-3M.2-I 13-01	КОЗТ 3.33-25.3	2	2428	
K3	I.220.I-3M.2-I 13-01	КОЗТ 3.33-25.3	4	2428	
K4	I.220.I-3M.2-I 17-02	КОФЗТ 3.33-40.7	1	2414	
K5	I.220.I-3M.2-I 17-02	КОФЗТ 3.33-40.7	2	2414	
K6	I.220.I-3M.2-I 13-01	КОЗТ 3.33-25.3	1	2428	
K7	I.220.I-3M.2-I 09	КОПТ 3.33-25.1	3	776	
K8	I.220.I-3M.2-I 13	КОЗТ 3.33-25.2	2	2373	
K9	I.220.I-3M.2-I 15-08	КОМЗТ 3.33-40.7	2	2509	
K10	I.220.I-3M.2-I 15-09	КОФЗТ 3.33-40.7	1	2490	
K11	I.220.I-3M.2-I 15-07	КОФЗТ 3.33-30.2	2	2396	
K12	I.220.I-3M.2-I 11-01	КОЗТ 3.33-25.3	4	2496	
K13	I.220.I-3M.2-I 13-04	КОЗТ 3.33-30.3	2	2428	
		РИТЕЛЬ			
P3	I.020-I/83.3-I 07-02	РОП 4.57-40	10	2070	
P4	I.020-I/83.3-I 02-03	РДП 4.57-70АТУ	15	2600	
P7	I.020-I/83.3-I 10-01	РОП 4.69-40	4	2520	
P8	I.020-I/83.3-I 04-03	РДП 4.69-70АТУ	8	3170	
		СВЯЗЕВАЯ ПЛИТА			
P11	I.041.I-2.I.200-01	ПК56.12-8АТИУС(АЛУ)Т-1	18	2000	
P12	I.041.I-2.I.400-02	ПК56.15-8АТИУС(АЛУ)Т-2	21	2600	
		I.220.I-3M.0-I.4 22-01			
		ЗТ 4.5.30-ЗАЛ(12)			
		40-2.5			
		РОСТВЕРК			
Ф1	I.220.I-3M.I-I 04-01	ФФ3-40	4	3625	
Ф2	I.220.I-3M.I-I 03-01	ИФ3-40	8	3755	
Ф3	I.220.I-3M.I-I 02-01	Ф2-40	3	2575	
Ф4	I.220.I-3M.I-I 03-01	ИФ3-40	5	3755	
Ф6		ФД9-40	3		
Ф7		ИФД9-40	1		
Ф12		ИФД9-40	1		
		КОЛОННА			
K1	I.220.I-3M.2-I 13-06	КОЗТ 3.33-40.7	4	2464	
K2	I.220.I-3M.2-I 13-04	КОЗТ 3.33-30.3	2	2428	
		I.220.I-3M.0-I.4 22			
					ЛИСТ 2

ФОРМАТ А 4

МАРКА ПОЗ	ОБОЗНАЧЕНИЕ	НАИМЕНОВАНИЕ	КОП	МАССА ЕД КГ	ПРИМЕЧАНИЕ
K3	I.220.I-3M.2-I 11-04	КОЗТ 3.33-30.3	4	2496	
K4	I.220.I-3M.2-I 17-02	КОФЗТ 3.33-40.7	1	2414	
K5	I.220.I-3M.2-I 17-02	КОФЗТ 3.33-40.7	2	2414	
K6	I.220.I-3M.2-I 13-04	КОЗТ 3.33-30.3	1	2428	
K7	I.220.I-3M.2-I 09	КОПТ 3.33-25.1	3	776	
K8	I.220.I-3M.2-I 13-01	КОЗТ 3.33-25.3	2	2428	
K9	I.220.I-3M.2-I 15-08	КОМЗТ 3.33-40.7	2	2509	
K10	I.220.I-3M.2-I 15-09	КОФЗТ 3.33-40.7	1	2490	
K11	I.220.I-3M.2-I 15-07	КОФЗТ 3.33-30.2	2	2396	
K12	I.220.I-3M.2-I 11-04	КОЗТ 3.33-30.3	4	2496	
K13	I.220.I-3M.2-I 13-04	КОЗТ 3.33-30.3	2	2428	
		РИТЕЛЬ			
P3	I.020-I/83.3-I 07-02	РОП 4.57-40	10	2070	
P4	I.020-I/83.3-I 02-03	РДП 4.57-70АТУ	15	2600	
P7	I.020-I/83.3-I 10-01	РОП 4.69-40	4	2520	
P8	I.020-I/83.3-I 04-03	РДП 4.69-70АТУ	8	3170	
		СВЯЗЕВАЯ ПЛИТА			
P11	I.041.I-2.I.200-01	ПК56.12-8АТИУС(АЛУ)Т-1	18	2000	
P12	I.041.I-2.I.400-02	ПК56.15-8АТИУС(АЛУ)Т-2	21	2600	
		I.220.I-3M.0-I.4 22-02			
		ЗТ 4.5.30-ЗАЛ(12)			
		40-4.0			
		РОСТВЕРК			
Ф1	I.220.I-3M.I-I 04-01	ФФ3-40	4	3625	
Ф2	I.220.I-3M.I-I 03-01	ИФ3-40	8	3755	
Ф3	I.220.I-3M.I-I 02-01	Ф2-40	3	2575	
Ф4	I.220.I-3M.I-I 03-01	ИФ3-40	5	3755	
Ф6		ФД9-40	3		
Ф7		ИФД9-40	1		
Ф12		ИФД9-40	1		
		КОЛОННА			
K1	I.220.I-3M.2-I 13-04	КОЗТ 3.33-30.3	4	2428	
K2	I.220.I-3M.2-I 13-01	КОЗТ 3.33-25.3	2	2428	
K3	I.220.I-3M.2-I 11-01	КОЗТ 3.33-25.3	4	2496	
		I.220.I-3M.0-I.4 22			
					ЛИСТ 3

ФОРМАТ А 4

23171-04 32

МАРКА ПОЗ	ОБОЗНАЧЕНИЕ	НАИМЕНОВАНИЕ	КОП	МАССА ЕД КГ	ПРИМЕЧАНИЕ
K4	I.220.I-3M.2-I 17-02	КОФЭТ 3.33-40.7	1	2414	
K5	I.220.I-3M.2-I 17-02	КОФЭТ 3.33-40.7	2	2414	
K6	I.220.I-3M.2-I 13-01	КОЭТ 3.33-25.3	1	2428	
K7	I.220.I-3M.2-I 09	КДПТ 3.33-25.1	3	776	
K8	I.220.I-3M.2-I 13-01	КОЭТ 3.33-25.3	2	2428	
K9	I.220.I-3M.2-I 15-08	КДМ 3.33-40.7	2	2509	
K10	I.220.I-3M.2-I 15-09	КДФЭТ 3.33-40.7	1	2490	
K11	I.220.I-3M.2-I 15-07	КДФЭТ 3.33-30.2	2	2396	
K12	I.220.I-3M.2-I 11-04	КДЭТ 3.33-30.3	4	2496	
K13	I.220.I-3M.2-I 13-04	КОЭТ 3.33-30.3	2	2428	
		РИГЕЛЬ			
P3	I.020-I/83.3-I 07-02	РОП 4.57-40АТУ	10	2070	
P4	I.020-I/83.3-I 02-03	РДП 4.57-70АТУ	15	2600	
P7	I.020-I/83.3-I 10-01	РОП 4.69-40АТУ	4	2520	
P8	I.020-I/83.3-I 04-03	РДП 4.69-70АТУ	8	3170	
		СВЯЗЕВАЯ ПЛИТА			
РП1	I.04I.I-2.I.200-0I	ПК56.12-8АТУС(А1У)Т-1	18	2000	
РП2	I.04I.I-2.I.400-02	ПК56.15-8АТУС(А1У)Т-2	2I	2600	
		I.220.I-2M.0-I.4 22-03			
		4Т 4.5.30-ЗАЛ(12)			
		32-3.5			
		РОСТВЕРК			
Ф1	I.220.I-3M.I-I 04	ФЭ3-32	4	4275	
Ф2	I.220.I-3M.I-I 03	ИЭ3-32	8	4390	
Ф3	I.220.I-3M.I-I 02	ФЭ2-32	3	2650	
Ф4	I.220.I-3M.I-I 05	Ф4-32	5	4775	
Ф6		ФД9-32	3		
Ф7		ИФД11-32	1		
Ф12		ИФД11-32	1		
		КОЛОННА			
K1	I.220.I-3M.2-I 18-02	КО4Т 3.33-40.3	4	3252	
K2	I.220.I-3M.2-I 18-02	КО4Т 3.33-40.3	2	3252	
K3	I.220.I-3M.2-I 18-04	КД4Т 3.33-40.2	4	3269	
K4	I.220.I-3M.2-I 24-03	КОФ4Т 3.33-40.7	1	3248	
		I.220.I-3M.0-I.4 22			
					ЛИСТ 4

ФОРМАТ А4

МАРКА ПОЗ	ОБОЗНАЧЕНИЕ	НАИМЕНОВАНИЕ	КОП	МАССА ЕД КГ	ПРИМЕЧАНИЕ
K5	I.220.I-3M.2-I 24-02	КОФ4Т 3.33-40.3	2	3199	
K6	I.220.I-3M.2-I 18-01	КО4Т 3.33-40.2	1	3179	
K7	I.220.I-3M.2-I 10-01	КДЭТ 3.33-25.2	3	1613	
K8	I.220.I-3M.2-I 18-01	КО4Т 3.33-40.2	2	3179	
K9	I.220.I-3M.2-I 18-06	КО4Т 3.33-40.7	2	3301	
K10	I.220.I-3M.2-I 27-02	КДФ4Т 3.33-40.3	1	3297	
K11	I.220.I-3M.2-I 27	КДФ4Т 3.33-30.2	2	3224	
K12	I.220.I-3M.2-I 18-05	КД4Т 3.33-40.3	4	3343	
K13	I.220.I-3M.2-I 18	КО4Т 3.33-30.2	2	3179	
		РИГЕЛЬ			
P3	I.020-I/83.3-I 07-02	РОП 4.57-40АТУ	15	2070	
P4	I.020-I/83.3-I 02-03	РДП 4.57-70АТУ	26	2600	
P7	I.020-I/83.3-I 10-01	РОП 4.69-40АТУ	6	2520	
P8	I.020-I/83.3-I 04-03	РДП 4.69-70АТУ	12	3170	
		СВЯЗЕВАЯ ПЛИТА			
РП1	I.04I.I-2.I.200-0I	ПК56.12-8АТУС(А1У)Т-1	26	2000	
РП2	I.04I.I-2.I.400-02	ПК56.15-8АТУС(А1У)Т-2	35	2600	
		I.220.I-3M.0-I.4 22-04			
		4Т 4.5.30-ЗАЛ(12)			
		40-2.5			
		РОСТВЕРК			
Ф1	I.220.I-3M.I-I 04-01	ФЭ3-40	4	3625	
Ф2	I.220.I-3M.I-I 03-01	ИЭ3-40	8	3755	
Ф3	I.220.I-3M.I-I 02-01	ФЭ2-40	3	2575	
Ф4	I.220.I-3M.I-I 05-01	Ф4-40	5	4100	
Ф6		ФД9-40	3		
Ф7		ИФД11-40	1		
Ф12		ИФД11-40	1		
		КОЛОННА			
K1	I.220.I-3M.2-I 18-02	КО4Т 3.33-40.3	4	3252	
K2	I.220.I-3M.2-I 18-02	КО4Т 3.33-40.3	2	3252	
K3	I.220.I-3M.2-I 18-05	КД4Т 3.33-40.3	4	3343	
K4	I.220.I-3M.2-I 24-03	КОФ4Т 3.33-40.7	1	3248	
K5	I.220.I-3M.2-I 24-03	КОФ4Т 3.33-40.3	2	3248	
		I.220.I-3M.0-I.4 22			
					ЛИСТ 5

23171-04 33

ФОРМАТ А4

МОНТАЖНЫЙ ПЛАН РОСТВЕРКОВ

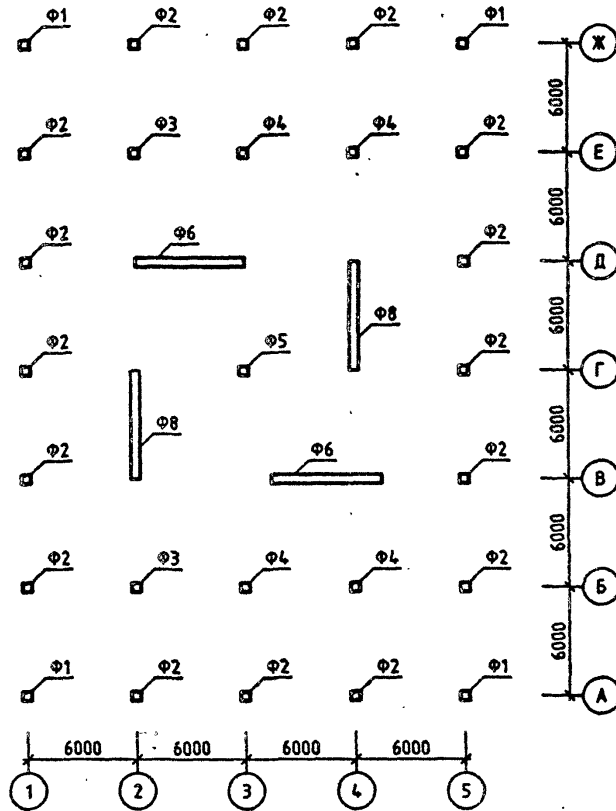

МОНТАЖНЫЙ ПЛАН КОЛОНН

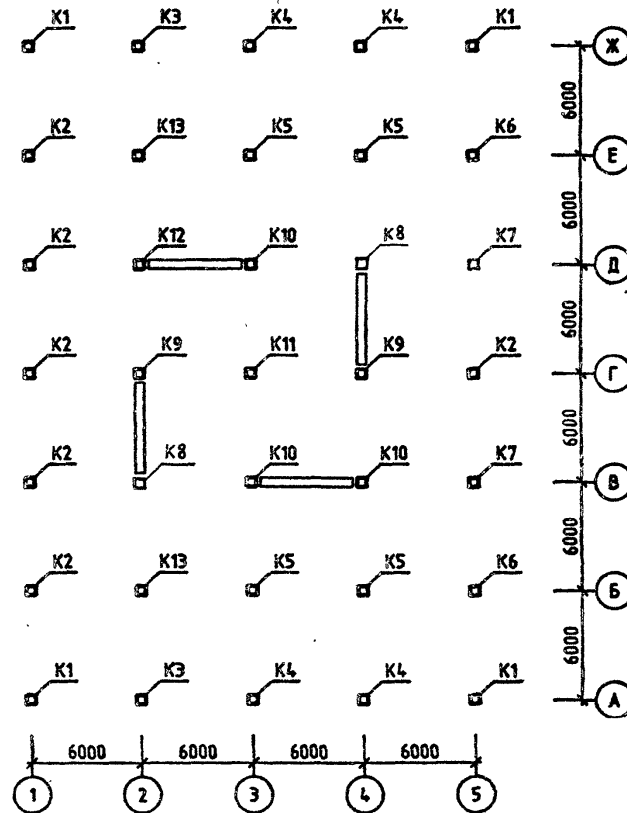

ОБОЗНАЧЕНИЕ	ШИФР ЗДАНИЯ
1.220.1-3М.0-1.4 21	ЭТ 6.4.30-ЗАЛ(2*12)40-2.5
-01	ЭТ 6.4.30-ЗАЛ(2*12)40-4.0
-02	ЛТ 6.4.30-ЗАЛ(2*12)40-2.5
-03	ЛТ 6.4.30-ЗАЛ(2*12)40-4.0

1.220.1-3М.0-1.4 210Б				
ЗДАНИЕ ЭТ 6.4-ЗАЛ(2*12) ЛТ 6.4-ЗАЛ(2*12)		С/ДАИЯ	Л/СТ	Л/СТОВ
		Р	1	3
Госгражданстрой КиевЗНИИЭП				

МОНТАЖНЫЙ ПЛАН РИГЕЛЕЙ

ОТМ. -2.32

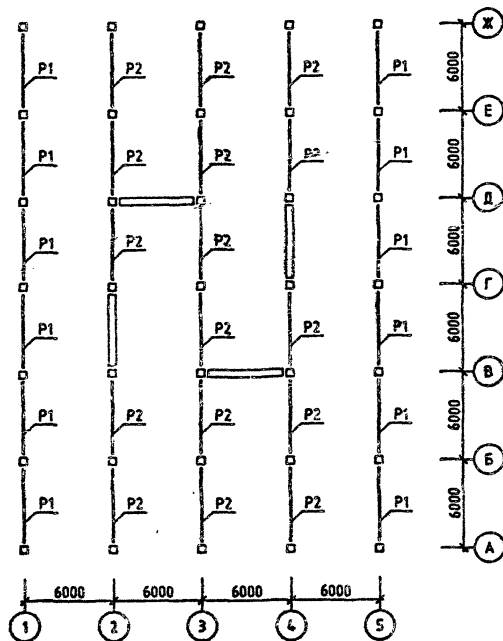

МОНТАЖНЫЙ ПЛАН РИГЕЛЕЙ И СВЯЗЕВЫХ ПЛИТ

ОТМ. -0.10 (+3.20)

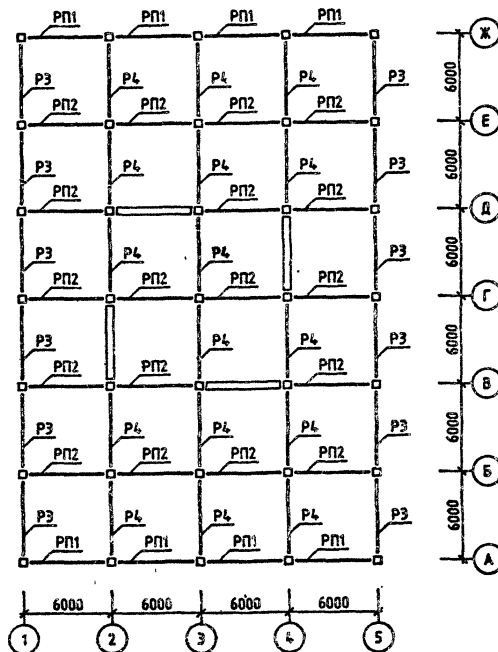

1.220.1-3М.0-1.4 210Б

ЛИСТ

2

23171-04 36 ФОРМАТ А3

МОНТАЖНЫЙ ПЛАН РИГЕЛЕЙ И СВЯЗЕВЫХ ПЛИТ

ОТМ. +3.20 (+6.50)

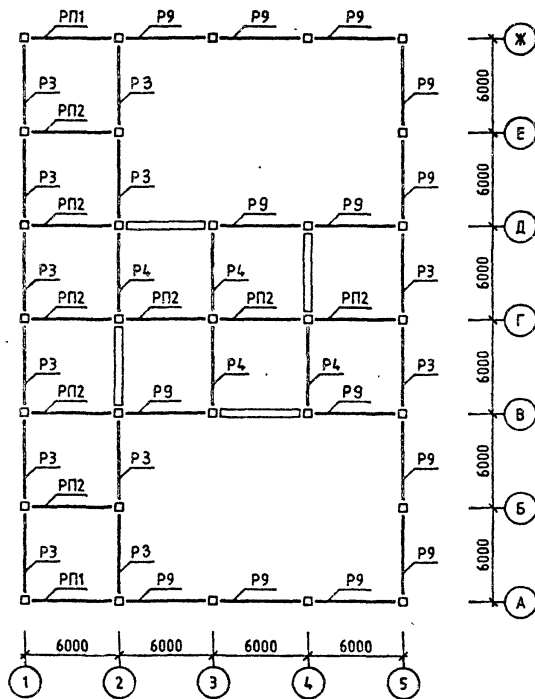

МОНТАЖНЫЙ ПЛАН РИГЕЛЕЙ И СВЯЗЕВЫХ ПЛИТ

ОТМ. +6.50 (+9.80)

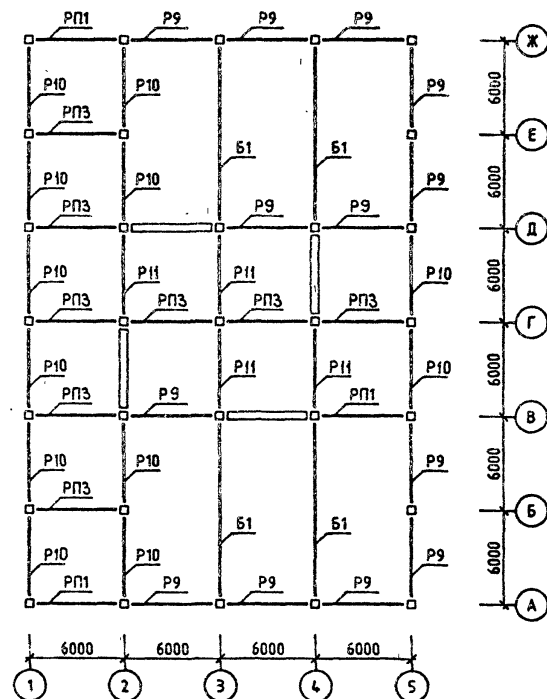

1.220.1-3М.0-1.4 210Б

ЛИСТ
3

МОНТАЖНЫЙ ПЛАН РОСТВЕРКОВ

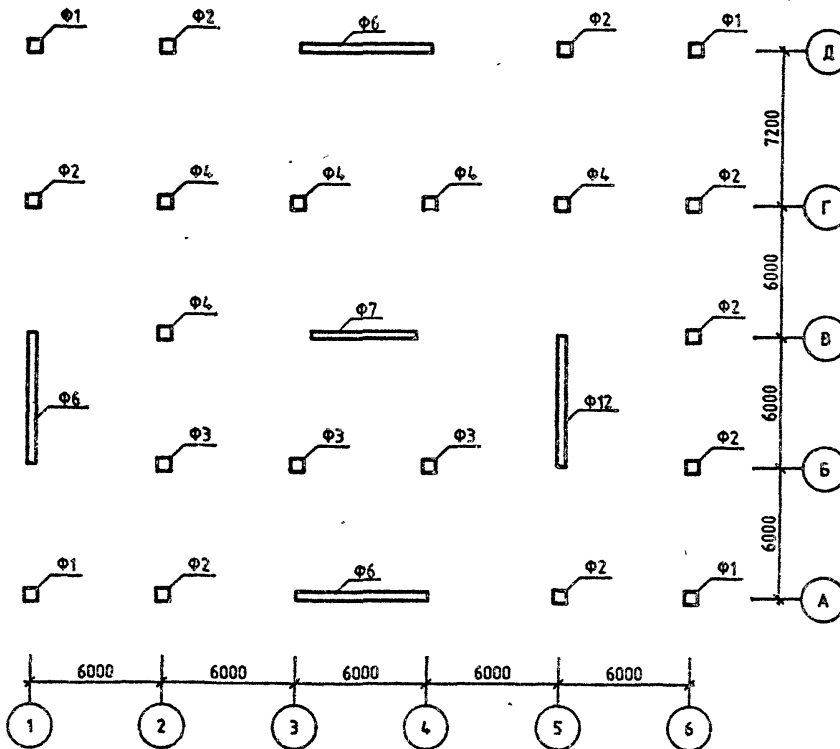

МОНТАЖНЫЙ ПЛАН КОЛОНН

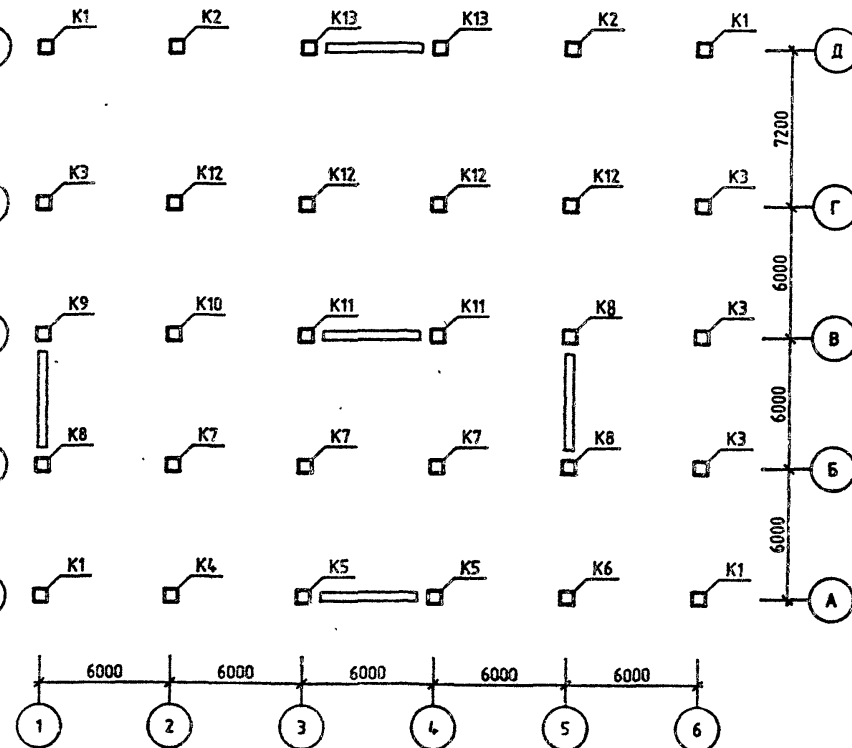

ОБОЗНАЧЕНИЕ	ШИФР ЗДАНИЯ
1.220.1-ЭМ.0-1.4 22	ЭТ 4.5.30-ЗАЛ(12)32-3.5
-01	ЭТ 4.5.30-ЗАЛ(12)40-2.5
-02	ЭТ 4.5.30-ЗАЛ(12)40-4.0
-03	4Т 4.5.30-ЗАЛ(12)32-3.5
-04	4Т 4.5.30-ЗАЛ(12)40-2.5
-05	4Т 4.5.30-ЗАЛ(12)40-4.0

Испол. отд.	Шевченко	<i>[Signature]</i>
ГИП	Егужов	<i>[Signature]</i>
ИНЖЕНТР	Зуево	<i>[Signature]</i>
ПРОВЕРИЛ	Бойко	<i>[Signature]</i>
РАЗРАБ	Рудавен	<i>[Signature]</i>

1.220.1-3М.0-1.4 220Б

ЗДАНИЕ
ЭТ 4.5-ЗАЛ(12)
4Т 4.5-ЗАЛ(12)

СТАДИЯ	ЛИСТ	ЛИСТОВ
Р	1	3

ГОСГРАЖДАНСТРОЙ
КиевЗНИИЭП

МОНТАЖНЫЙ ПЛАН РИГЕЛЕЙ

ОТМ. -2.32

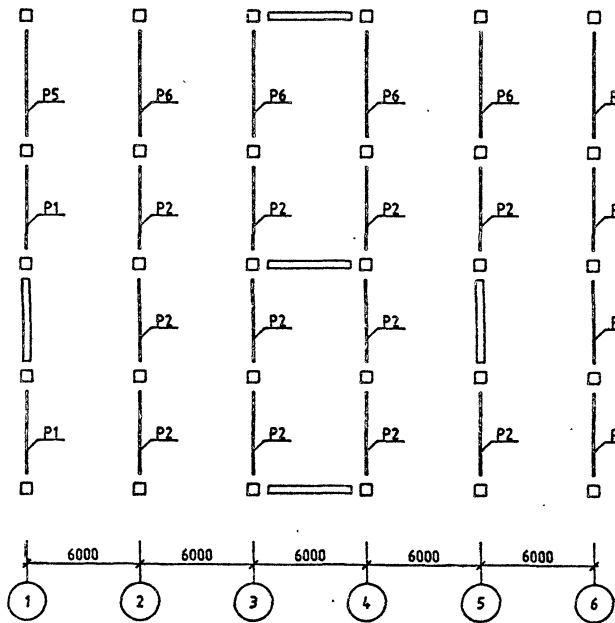

МОНТАЖНЫЙ ПЛАН РИГЕЛЕЙ И СВЯЗЕВЫХ ПЛИТ

ОТМ. -0.10 (+3.20)

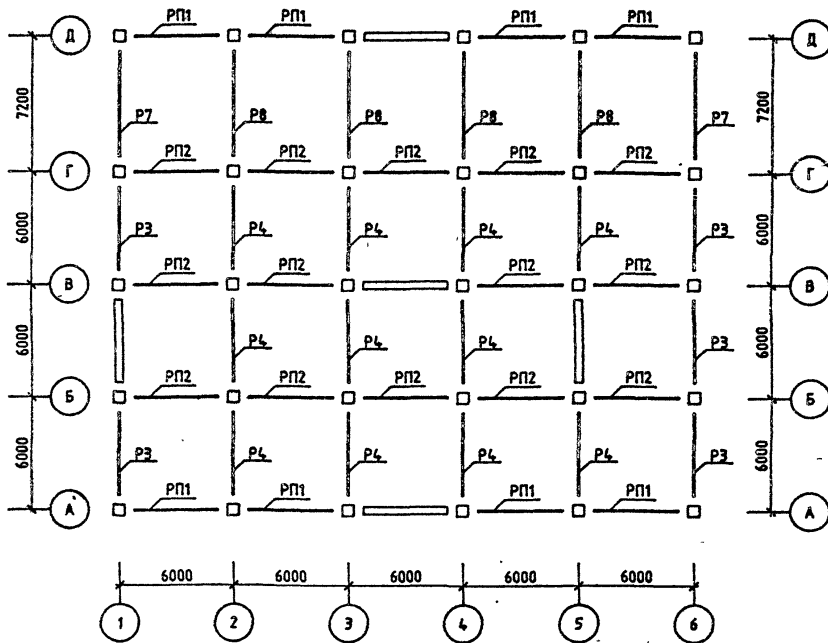

1.220.1-3М.0-1.4 220Б

ЛИСТ
2

23171-04 30
ФОРМАТ А3

Номер загрузки	Тип усилия	Номер группы элементов								
		1	2	3	4	5	6	7	8	
ЯРУС 1 СЕЧЕНИЕ 1										
1	N	0.0	0.0	0.0	0.0	-14.4	-14.1	0.0	0.0	
	MX	-10.2	-11.9	15.2	15.4	-42.7	-14.0	-7.3	-13.6	
	QU	2.9	3.1	-4.1	-4.0	32.9	4.2	1.5	3.4	
	MU	-8.3	-10.8	0.6	2.6	-14.0	-42.1	-5.2	-8.7	
	QX	-1.1	-1.4	0.2	0.7	4.1	-32.5	-0.2	-0.3	
8	N	0.0	0.0	0.0	0.0	0.1	-23.9	0.0	0.0	
	MX	0.1	0.1	0.0	0.1	-0.1	0.1	0.0	0.0	
	QU	0.0	0.0	0.0	0.0	0.1	0.0	0.0	0.0	
	MU	-0.3	-0.7	-0.6	-0.9	-1.5	-8.8	-0.5	-0.5	
	QX	0.0	0.1	-0.1	-0.2	-0.4	-1.1	-0.1	-0.1	
9	N	0.0	3.0	0.0	0.0	-16.2	0.1	0.0	0.0	
	MX	0.3	0.5	0.5	0.7	6.0	1.0	0.4	-0.3	
	QU	-0.1	-0.1	-0.1	-0.2	-4.8	-0.3	-0.1	0.2	
	MU	0.0	0.0	0.0	0.0	0.0	0.0	0.0	0.0	
	QX	0.0	0.0	0.0	0.0	0.0	0.0	0.0	0.0	
14	N	94.5	127.1	112.2	160.4	125.3	120.4	82.4	117.4	
	MX	0.5	0.4	0.6	0.0	4.5	0.1	0.1	2.4	
	QU	-0.5	-0.2	-1.1	0.0	-4.9	-0.1	0.0	-1.8	
	MU	0.7	0.9	0.1	0.1	0.1	4.8	0.0	0.0	
	QX	0.9	1.4	0.0	0.0	0.0	5.2	0.0	0.0	
ЯРУС 1 СЕЧЕНИЕ 2										
1	N	0.0	0.0	0.0	0.0	14.4	14.1	0.0	0.0	
	MX	3.0	4.0	-5.0	-5.5	-39.6	3.6	3.6	5.1	
	QU	-2.9	-3.1	4.1	4.0	-32.9	-4.2	-1.5	-3.4	
	MU	-2.5	4.1	-0.1	-0.9	3.6	-39.0	2.5	-3.0	
	QX	1.1	1.4	-0.2	-0.7	-4.1	32.5	0.2	0.3	
8	N	0.0	0.0	0.0	0.0	-0.1	23.9	0.0	0.0	
	MX	0.0	0.0	0.0	0.0	-0.1	0.0	0.0	0.0	
	QU	0.0	0.0	0.0	0.0	-0.1	0.0	0.0	0.0	
	MU	0.2	0.3	0.3	0.4	0.5	-8.9	0.3	0.3	
	QX	0.1	-0.1	0.1	0.2	0.4	7.0	0.1	0.1	
9	N	0.0	0.0	0.0	0.0	16.2	-0.1	0.0	0.0	
	MX	-0.1	-0.2	-0.2	-0.3	6.1	-0.3	-0.2	-0.2	
	QU	0.1	0.1	0.1	0.2	4.8	0.3	0.1	-0.2	
	MU	0.0	0.0	0.0	0.0	0.0	0.0	0.0	0.0	
	QX	0.0	0.0	0.0	0.0	0.0	0.0	0.0	0.0	
14	N	-94.5	-127.1	-112.2	-160.4	-125.3	-120.4	-82.4	-117.4	
	MX	-0.9	0.0	2.1	0.0	7.7	0.1	0.0	-2.1	
	QU	-0.5	0.0	1.1	0.0	4.9	0.1	0.0	-1.8	
	MU	1.5	-2.6	0.0	0.0	0.0	8.2	0.0	0.0	
	QX	0.9	1.0	0.0	0.0	0.0	5.1	0.0	0.0	
1.220.1-3М.0-1.4 21МУ1										
ГИП	Егунов					СТАДИЯ	ЛИСТ	ЛИСТОВ		
Н.КОНТР	Бойко					Р	1	3		
РУК.ГР	Рудавин					ЗДАНИЕ				
ПРОВЕРИЛ	Футорная					ДТ 6.4.30-ЗАЛ(2*12)40-2.5				
РАЗРАБ	Зуенко					ГОСГРАЖДАНСТРОЙ				
					КиевЗНИИЭП					

ФОРМАТ А 4

Номер загрузки	Тип усилия	Номер группы элементов							
		1	2	3	4	5	6	7	8
ЯРУС 2 СЕЧЕНИЕ 1									
1	N	0.0	0.0	0.0	0.0	-11.1	-10.7	0.0	0.0
	MX	-3.0	-4.0	5.0	5.5	0.5	-1.9	-3.6	-5.1
	QU	2.9	3.1	-4.1	-4.0	-0.4	1.8	1.5	3.4
	MU	2.5	-4.7	0.1	0.9	-1.9	0.5	-2.5	3.0
	QX	-1.1	-1.4	0.2	0.7	1.8	0.3	-0.2	-0.3
8	N	0.0	0.0	0.0	0.0	0.0	-7.9	0.0	0.0
	MX	0.0	0.0	0.0	0.0	0.0	0.0	0.0	0.0
	QU	0.0	0.0	0.0	0.0	0.0	0.0	0.0	0.0
	MU	-0.2	-0.3	-0.3	-0.4	-0.2	-0.2	-0.3	-0.3
	QX	-0.1	0.1	-0.1	-0.2	-0.2	-0.2	-0.1	-0.1
9	N	0.0	0.0	0.0	0.0	3.3	0.0	0.0	0.0
	MX	0.1	0.2	0.2	0.3	0.2	0.1	0.2	0.2
	QU	-0.1	-0.1	-0.1	-0.2	-0.1	-0.1	-0.1	0.2
	MU	0.0	0.0	0.0	0.0	0.0	0.0	0.0	0.0
	QX	0.0	0.0	0.0	0.0	0.0	0.0	0.0	0.0
14	N	67.0	93.2	79.5	122.1	50.4	48.2	44.1	84.7
	MX	0.6	0.0	1.2	0.0	-0.3	0.1	0.0	1.1
	QU	-0.4	0.0	-1.1	0.0	0.1	-0.1	0.0	-1.8
	MU	-1.0	1.5	0.0	0.0	0.0	-0.4	0.0	0.0
	QX	-0.8	-1.0	0.0	0.0	0.0	0.1	0.0	0.0
ЯРУС 2 СЕЧЕНИЕ 2									
1	N	0.0	0.0	0.0	0.0	11.1	10.7	0.0	0.0
	MX	-4.0	-3.5	4.7	3.9	0.3	-2.3	0.0	-3.0
	QU	-2.9	-3.1	4.1	4.0	0.4	-1.8	1.3	-3.4
	MU	-3.1	-3.3	0.4	0.8	-2.3	0.3	0.0	-2.4
	QX	1.1	1.4	-0.2	-0.7	-1.8	-0.3	0.4	0.3
8	N	0.0	0.0	0.0	0.0	0.0	7.9	0.0	0.0
	MX	0.1	0.1	0.0	0.0	0.0	0.0	0.0	0.0
	QU	0.0	0.0	0.0	0.0	0.0	0.0	0.0	0.0
	MU	0.1	0.7	0.0	-0.2	-0.2	-0.2	0.0	0.1
	QX	0.0	-0.1	0.1	0.2	0.2	0.2	0.1	0.1
9	N	0.0	0.0	0.0	0.0	-5.3	0.0	0.0	0.0
	MX	0.1	0.1	0.1	0.2	0.1	0.1	0.0	-0.7
	QU	0.1	0.1	0.1	0.2	0.1	0.1	0.1	-0.2
	MU	0.0	0.0	0.0	0.0	0.0	0.0	0.0	0.0
	QX	0.0	0.0	0.0	0.0	0.0	0.0	0.0	0.0
14	N	-67.0	-93.2	-79.5	-122.1	-50.4	-48.2	-44.1	-84.7
	MX	0.8	0.4	1.4	0.0	-0.2	0.2	0.0	3.2
	QU	0.5	0.2	1.1	0.0	0.1	0.1	0.0	1.8
	MU	1.1	1.8	0.1	0.1	0.0	-0.1	0.0	0.0
	QX	-0.9	-1.4	0.0	0.0	0.0	0.1	0.0	0.0
1.220.1-3М.0-1.4 21МУ1									
ИНВ № ПОДЛ									ЛИСТ
									2

23171-04 41

ФОРМАТ А 4

Номер загрузки	Тип усилия	Номер группы элементов							
		1	2	3	4	5	6	7	8
ЯРУС 3 СЕЧЕНИЕ 1									
1	N	0.0	0.0	0.0	0.0	-3.8	-3.7	0.0	0.0
	MX	4.0	3.5	-4.7	-3.9	0.2	1.6	0.0	3.0
	QY	-1.4	-1.2	1.7	1.4	-0.1	-0.7	0.0	-0.5
	MU	3.1	3.3	-0.4	-0.9	1.5	0.2	0.0	2.4
	QX	0.8	0.2	-0.3	-0.3	-0.6	0.1	0.0	0.4
8	N	0.0	0.0	0.0	0.0	0.0	4.3	0.0	0.0
	MX	-0.1	-0.1	0.0	0.0	0.0	0.0	0.0	0.0
	QY	0.0	0.0	0.0	0.0	0.0	0.0	0.0	0.0
	MU	-0.1	-0.7	0.0	0.2	0.1	-0.1	0.0	-0.1
	QX	-0.1	-0.4	0.0	0.0	0.1	-0.1	0.0	0.0
9	N	0.0	0.0	0.0	0.0	3.0	0.1	0.0	0.0
	MX	-0.1	-0.1	-0.1	-0.2	0.1	-0.1	0.0	-0.7
	QY	0.0	0.0	0.0	0.1	-0.1	0.1	0.0	-0.5
	MU	0.0	0.0	0.0	0.0	0.0	0.0	0.0	0.0
	QX	0.0	0.0	0.0	0.0	0.0	0.0	0.0	0.0
14	N	44.3	60.9	48.4	78.0	21.2	17.6	0.0	53.6
	MX	0.4	-0.4	0.5	0.0	-0.6	-0.2	0.0	-1.2
	QY	-0.3	0.6	-0.1	0.0	0.4	0.2	0.0	1.2
	MU	-0.3	-2.2	-0.1	-0.1	0.0	-0.4	0.0	0.0
	QX	-0.4	0.7	0.0	-0.1	0.0	-0.3	0.0	0.0
ЯРУС 3 СЕЧЕНИЕ 2									
1	N	0.0	0.0	0.0	0.0	0.0	3.7	0.0	0.0
	MX	0.6	-0.5	-0.9	-0.2	0.1	0.5	0.0	-1.5
	QY	1.1	-1.2	-1.7	-1.1	0.1	0.7	0.0	0.9
	MU	0.9	-1.2	-0.4	-0.0	0.6	0.1	0.0	0.6
	QX	0.9	0.9	0.3	0.3	0.3	-0.1	0.0	-0.4
8	N	0.0	0.0	0.0	0.0	0.0	-4.3	0.0	0.0
	MX	0.1	0.1	0.0	0.0	0.0	0.0	0.0	0.0
	QY	0.0	0.0	0.0	0.0	0.0	0.0	0.0	0.0
	MU	-0.3	-1.1	-0.1	0.1	-0.1	-0.1	0.0	-0.7
	QX	0.1	0.5	0.0	0.0	-0.1	0.1	0.0	0.0
9	N	0.0	0.0	0.0	0.0	-3.0	-0.1	0.0	0.0
	MX	0.0	0.0	0.0	-0.1	0.1	-0.1	0.0	1.1
	QY	0.0	0.0	0.0	-0.1	0.1	-0.1	0.0	0.5
	MU	0.0	0.0	0.0	0.0	0.0	0.0	0.0	0.0
	QX	0.0	0.0	0.0	0.0	0.0	0.0	0.0	0.0
14	N	-44.3	-60.9	-48.4	-78.0	-21.2	-17.6	0.0	-53.6
	MX	-0.9	-1.4	-0.1	0.0	-0.6	0.5	0.0	2.9
	QY	-0.3	-0.5	0.1	0.0	-0.4	0.2	0.0	1.2
	MU	-0.6	2.4	-0.1	-0.1	0.1	-0.5	0.0	-0.1
	QX	-0.4	0.7	0.0	0.0	0.0	-0.2	0.0	0.0

1.220.1-3М.0-1.4 21МУ1

ЛИСТ

3

Номер загрузки	Тип усилия	Номер группы элементов							
		1	2	3	4	5	6	7	8
ЯРУС 1 СЕЧЕНИЕ 1									
1	N	0.0	0.0	0.0	0.0	-20.5	-20.5	0.0	0.0
	MX	-6.3	-7.8	10.3	11.7	-22.7	-8.9	-5.2	-9.4
	QY	1.4	1.6	-2.1	-2.2	11.2	2.1	0.8	1.8
	MU	-4.9	-7.2	1.1	2.9	-8.8	-22.3	-3.4	-5.4
	QX	-0.6	-0.9	0.2	0.6	2.0	-11.0	-0.2	-0.3
8	N	0.0	0.0	0.0	0.0	0.1	-26.4	0.0	0.0
	MX	0.1	0.1	0.0	0.0	-0.2	0.1	0.0	0.0
	QY	0.0	0.0	0.0	0.0	0.1	0.0	0.0	0.0
	MU	-0.8	-1.6	-1.4	-2.7	-3.5	-13.6	-1.2	-1.4
	QX	-0.1	-0.1	-0.3	-0.5	-0.8	-6.7	-0.2	-0.3
9	N	0.0	0.0	0.0	0.0	-17.2	0.1	0.0	0.0
	MX	0.5	1.1	1.1	1.0	9.2	2.4	0.2	0.3
	QY	-0.1	-0.2	-0.2	-0.3	-4.5	-0.5	-0.1	0.0
	MU	0.0	0.0	0.0	0.0	0.0	0.0	0.0	0.0
	QX	0.0	0.0	0.0	0.0	0.0	0.0	0.0	0.0
14	N	94.5	127.1	112.2	160.4	139.0	134.8	82.4	117.4
	MX	0.7	0.4	1.4	0.3	2.3	0.2	0.0	3.0
	QY	-0.4	-0.1	-0.9	0.0	-2.5	-0.1	0.0	-1.4
	MU	1.1	1.0	0.0	0.1	0.1	3.8	0.0	0.0
	QX	0.7	1.2	0.0	0.0	0.0	2.6	-0.9	0.0
ЯРУС 1 СЕЧЕНИЕ 2									
1	N	0.0	0.0	0.0	0.0	20.5	20.5	0.0	0.0
	MX	0.8	1.5	-2.0	-2.7	-22.2	-0.6	1.9	2.3
	QY	-1.4	-1.6	2.1	2.2	-11.2	2.0	-0.8	-1.8
	MU	-0.5	1.7	-0.1	-0.6	0.6	-21.0	1.3	-1.1
	QX	0.6	0.9	-0.2	-0.6	-2.0	-10.0	0.2	0.0
8	N	0.0	0.0	0.0	0.0	-0.1	26.4	0.0	0.0
	MX	0.0	0.0	0.0	0.0	-0.1	0.0	0.0	0.0
	QY	0.0	0.0	0.0	0.0	-0.1	0.0	0.0	0.0
	MU	0.2	0.6	0.4	0.6	0.4	-13.1	0.5	0.4
	QX	0.2	0.3	0.3	0.5	0.8	6.5	0.2	0.2
9	N	0.0	0.0	0.0	0.0	17.3	-0.1	0.0	0.0
	MX	-0.1	-0.2	-0.2	-0.4	2.8	-0.2	-0.3	-0.4
	QY	0.1	0.2	0.2	0.3	4.5	0.5	0.1	0.0
	MU	0.0	0.0	0.0	0.0	0.0	0.0	0.0	0.0
	QX	0.0	0.0	0.0	0.0	0.0	0.0	0.0	0.0
14	N	-94.5	-127.1	-112.2	-160.4	-139.0	-134.8	-82.4	-117.4
	MX	-1.0	0.1	2.3	0.0	6.3	0.2	0.0	-2.8
	QY	-0.4	0.1	0.9	0.0	2.5	0.1	0.0	-1.4
	MU	1.7	-2.9	0.0	0.0	0.0	6.7	0.0	0.0
	QX	0.7	-1.2	0.0	0.0	0.0	2.6	0.0	0.0

ИНВ № ПОДП
ПОДПИСЬ И ДАТА
ВЗАМ ИНВ №

Безуглова
ОПЕРАТОР СИСТЕМЫ
САПР
КиевЗНИИЭП

1.220.1-3М.0-1.4 21МУ1

ГИП	Егунов		СТАДИЯ	ЛИСТ	ЛИСТОВ
И КОНТР	Бойко		Р	7	3
РУК.ГР	Рудавин		ЗДАНИЕ ИТ 6.4.30-ЗАЛ(2*12)40-4.0 ГОСГРАЖДАНСТРОЙ КиевЗНИИЭП		
ПРОВЕРИЛ	Футорная				
РАЗРАБ	Зуенко				

Номер загрузки	Тип усилия	Номер группы элементов							
		1	2	3	4	5	6	7	8
ЯРУС 2 СЕЧЕНИЕ 1									
1	N	0.0	0.0	0.0	0.0	3.6	3.3	0.0	0.0
	MX	-0.8	-1.5	2.0	2.7	0.5	-0.8	-1.9	-2.3
	QY	1.4	1.6	-2.1	-2.2	-0.4	0.9	0.8	1.8
	MU	0.6	-1.7	0.1	0.6	-0.8	0.4	-1.3	1.1
	QX	-0.6	-0.9	0.2	0.6	0.9	0.3	-0.2	-0.3
8	N	0.0	0.0	0.0	0.0	-0.1	-6.2	0.0	0.0
	MX	0.0	0.0	0.0	0.0	0.0	0.0	0.0	0.0
	QY	0.0	0.0	0.0	0.0	0.0	0.0	0.0	0.0
	MU	-0.2	-0.6	-0.4	-0.6	-0.3	0.0	-0.5	-0.4
	QX	-0.2	-0.3	-0.3	-0.5	-0.4	0.0	-0.2	-0.2
9	N	0.0	0.0	0.0	0.0	4.2	0.0	0.0	0.0
	MX	0.1	0.2	0.2	0.4	0.0	0.2	0.3	0.4
	QY	-0.1	-0.2	-0.2	-0.3	0.0	-0.2	-0.1	0.0
	MU	0.0	0.0	0.0	0.0	0.0	0.0	0.0	0.0
	QX	0.0	0.0	0.0	0.0	0.0	0.0	0.0	0.0
14	N	67.0	93.2	79.5	122.1	56.0	54.0	44.1	84.7
	MX	0.5	-0.1	0.9	0.0	-0.5	0.1	0.0	0.5
	QY	-0.4	-0.1	-0.9	0.0	0.2	-0.1	0.0	-1.4
	MU	-0.8	1.4	0.0	0.0	0.0	-0.7	0.0	0.0
	QX	-0.7	1.2	0.0	0.0	0.0	-0.3	0.0	0.0
ЯРУС 2 СЕЧЕНИЕ 2									
1	N	0.0	0.0	0.0	0.0	-3.6	-3.3	0.0	0.0
	MX	-2.5	-2.2	3.0	2.6	0.4	-1.4	0.0	-2.0
	QY	-1.4	-1.6	2.1	2.2	0.4	-0.9	0.7	-1.8
	MU	-1.9	-2.1	0.4	0.7	-1.4	0.4	0.0	-1.4
	QX	0.6	0.9	-0.2	-0.6	-0.9	-0.3	0.2	0.3
8	N	0.0	0.0	0.0	0.0	0.1	6.2	0.0	0.0
	MX	-0.1	-0.1	0.0	0.0	0.0	0.0	0.0	0.0
	QY	0.0	0.0	0.0	0.0	0.0	0.0	0.0	0.0
	MU	0.2	-0.5	-0.3	-0.6	-0.5	0.0	0.0	-0.2
	QX	0.2	0.3	0.3	0.5	0.4	0.0	0.2	0.3
9	N	0.0	0.0	0.0	0.0	-4.2	0.0	0.0	0.0
	MX	0.2	0.3	0.3	0.4	0.0	0.4	0.0	-0.5
	QY	0.1	0.2	0.2	0.3	0.0	0.2	0.1	0.0
	MU	0.0	0.0	0.0	0.0	0.0	0.0	0.0	0.0
	QX	0.0	0.0	0.0	0.0	0.0	0.0	0.0	0.0
14	N	-67.0	-93.2	-79.5	-122.1	-56.0	-54.0	-44.1	-84.7
	MX	0.7	0.3	1.3	0.0	0.0	0.2	0.0	2.9
	QY	0.4	0.1	0.9	0.0	0.2	0.1	0.0	1.4
	MU	0.9	1.7	0.1	0.1	0.0	-0.1	0.0	0.0
	QX	-0.7	-1.2	0.0	0.0	0.0	0.3	0.0	0.0

1.220.1-3М.0-1.4 21МУ2

ЛИСТ

2

Номер загрузки	Тип усилия	Номер группы элементов							
		1	2	3	4	5	6	7	8
ЯРУС 3 СЕЧЕНИЕ 1									
1	N	0.0	0.0	0.0	0.0	2.0	2.0	0.0	0.0
	MX	2.5	2.2	-3.0	-2.6	0.1	1.1	0.0	2.0
	QY	-0.9	-0.8	1.1	1.0	-0.1	-0.4	0.0	-0.3
	MU	1.9	2.1	-0.4	-0.7	1.0	0.1	0.0	1.4
	QX	0.5	0.1	-0.2	-0.3	-0.4	0.0	0.0	0.3
8	N	0.0	0.0	0.0	0.0	0.0	4.1	0.0	0.0
	MX	0.1	0.1	0.0	0.0	0.0	0.0	0.0	0.0
	QY	0.0	0.0	0.0	0.0	0.0	0.0	0.0	0.0
	MU	0.2	0.5	0.3	0.6	0.4	-0.1	0.0	0.2
	QX	0.0	0.1	0.0	0.2	0.2	-0.1	0.0	0.0
9	N	0.0	0.0	0.0	0.0	2.8	0.1	0.0	0.0
	MX	-0.2	-0.3	-0.3	-0.4	0.1	-0.3	0.0	0.5
	QY	0.1	0.1	0.1	0.2	0.0	0.1	0.0	-0.5
	MU	0.0	0.0	0.0	0.0	0.0	0.0	0.0	0.0
	QX	0.0	0.0	0.0	0.0	0.0	0.0	0.0	0.0
14	N	44.3	60.9	48.4	78.0	22.7	19.2	0.0	53.6
	MX	0.4	-0.3	0.7	0.0	-0.5	-0.2	0.0	-1.0
	QY	-0.3	0.5	-0.2	0.0	0.4	0.2	0.0	1.2
	MU	-1.0	-2.3	-0.1	-0.1	0.0	-0.3	0.0	0.0
	QX	-0.5	0.7	0.0	0.0	0.0	-0.2	0.0	0.0
ЯРУС 3 СЕЧЕНИЕ 2									
1	N	0.0	0.0	0.0	0.0	-2.0	-2.0	0.0	0.0
	MX	-0.4	-0.4	-0.6	-0.5	0.1	0.4	0.0	-1.0
	QY	-0.9	-0.8	-1.1	-1.0	0.1	0.4	0.0	0.3
	MU	0.5	-0.8	-0.2	-0.2	0.4	0.1	0.0	0.4
	QX	0.5	0.6	0.2	0.3	0.4	0.0	0.0	-0.3
8	N	0.0	0.0	0.0	0.0	0.0	-4.1	0.0	0.0
	MX	-0.1	-0.1	-0.1	0.0	0.0	0.0	0.0	0.0
	QY	0.0	0.0	0.0	0.0	0.0	0.0	0.0	0.0
	MU	-0.4	-1.2	-0.1	0.1	0.2	-0.1	0.0	-0.4
	QX	0.1	0.4	0.0	-0.2	-0.2	0.1	0.0	0.0
9	N	0.0	0.0	0.0	0.0	-2.8	-0.1	0.0	0.0
	MX	0.0	-0.1	-0.1	-0.1	0.1	-0.1	0.0	1.2
	QY	-0.1	-0.1	-0.1	-0.2	0.0	-0.1	0.0	0.5
	MU	0.0	0.0	0.0	0.0	0.0	0.0	0.0	0.0
	QX	0.0	0.0	0.0	0.0	0.0	0.0	0.0	0.0
14	N	-44.3	-60.9	-48.4	-78.0	-22.7	-19.2	0.0	-53.6
	MX	-0.9	-1.4	-0.1	0.0	-0.7	0.5	0.0	3.0
	QY	-0.2	-0.5	0.2	0.0	-0.4	0.2	0.0	1.2
	MU	-0.7	2.3	-0.1	-0.1	0.0	-0.5	0.0	0.0
	QX	-0.5	0.7	0.0	0.0	0.0	-0.2	0.0	0.0

1.220.1-3М.0-1.4 21МУ2

ЛИСТ

3

Номер загрузки	Тип усилки	Номер группы элементов							
		1	2	3	4	5	6	7	8
ЯРУС 1 СЕЧЕНИЕ 1									
1	N	0.0	0.0	0.0	0.0	-14.5	-14.1	0.0	0.0
	MX	-10.1	-11.7	15.1	15.3	-42.6	-13.6	-10.4	-15.1
	QY	2.9	3.1	-4.0	-3.9	32.8	4.0	2.7	4.0
	MU	-8.2	-12.0	0.7	2.8	-13.8	-42.5	-7.3	-8.6
	QX	-1.0	-1.8	0.2	0.8	4.1	-32.7	-0.5	-0.3
8	N	0.0	0.0	0.0	0.0	0.1	-37.5	0.0	0.0
	MX	0.0	0.0	0.0	0.0	0.0	0.0	0.0	0.0
	QY	0.0	0.0	0.0	0.0	0.0	0.0	0.0	0.0
	MU	-0.5	-1.0	-0.8	-1.2	-1.8	-11.0	-0.8	-0.8
	QX	-0.1	-0.3	-0.2	-0.3	-0.4	-9.1	-0.2	-0.2
9	N	0.0	0.0	0.0	0.0	-25.3	0.0	0.0	0.0
	MX	0.3	0.5	0.5	0.8	7.4	1.2	0.5	0.7
	QY	-0.1	-0.1	-0.1	-0.2	-6.2	-0.3	-0.1	-0.2
	MU	0.0	0.0	0.0	0.0	0.0	0.0	0.0	0.0
	QX	0.0	0.0	0.0	0.0	0.0	0.0	0.0	0.0
14	N	117.1	159.4	143.3	204.5	152.8	148.8	126.5	148.5
	MX	0.3	-0.1	0.3	0.0	-7.0	0.0	0.0	-0.2
	QY	-0.4	0.0	-1.0	0.0	7.5	0.0	0.0	-0.8
	MU	-0.6	1.0	0.0	0.0	0.0	7.4	0.0	0.0
	QX	-0.8	1.2	0.0	0.0	0.0	8.0	0.0	0.0
ЯРУС 1 СЕЧЕНИЕ 2									
1	N	0.0	0.0	0.0	0.0	14.5	14.1	0.0	0.0
	MX	2.9	3.9	-5.0	-5.5	-39.5	3.6	3.5	5.0
	QY	-2.9	-3.1	4.0	3.9	-32.8	-4.0	-2.7	-4.0
	MU	2.4	4.0	-0.1	-0.9	3.6	-39.3	2.5	2.9
	QX	1.0	1.8	-0.2	-0.8	-4.1	32.7	0.5	0.3
8	N	0.0	0.0	0.0	0.0	-0.1	37.5	0.0	0.0
	MX	0.0	0.0	0.0	0.0	0.0	0.0	0.0	0.0
	QY	0.0	0.0	0.0	0.0	0.0	0.0	0.0	0.0
	MU	0.2	0.3	0.3	0.5	0.7	-11.8	0.3	0.3
	QX	0.1	0.2	0.2	0.3	0.4	9.1	0.2	0.2
9	N	0.0	0.0	0.0	0.0	25.3	0.0	0.0	0.0
	MX	-0.1	-0.2	-0.2	-0.3	8.0	-0.5	-0.2	-0.2
	QY	0.1	0.1	0.1	0.2	6.2	0.3	0.1	0.2
	MU	0.0	0.0	0.0	0.0	0.0	0.0	0.0	0.0
	QX	0.0	0.0	0.0	0.0	0.0	0.0	0.0	0.0
14	N	-117.1	-159.4	-143.3	-204.5	-152.8	-148.8	-126.5	-148.5
	MX	0.8	0.0	2.1	0.0	-12.0	0.0	0.0	2.1
	QY	0.4	0.0	1.0	0.0	-7.6	0.0	0.0	0.8
	MU	1.5	2.6	0.0	0.0	0.0	12.7	0.0	0.0
	QX	0.8	-1.3	0.0	0.0	0.0	8.0	0.0	0.0

		1.220.1-3Ж.0-1.4 21МУЗ	
ГИП	Егунов		
И.КОНТР.	Бойко		
РУК.ГР.	Рудавин		
ПРОВЕРИЛ	Футормая		
РАЗРАБ.	Зуежко		
		ЗДАНИЕ	
		ИТ 6.4.30-ЗАЛ(2*12)40-2.5	
СТАДИЯ	ЛИСТ	ЛИСТОВ	
Г	1	4	
		ГОСГРАЖДАНСТРОЙ	
		КиевЗНИИЭП	

ФОРМАТ А4

Номер загрузки	Тип усилки	Номер группы элементов							
		1	2	3	4	5	6	7	8
ЯРУС 2 СЕЧЕНИЕ 1									
1	N	0.0	0.0	0.0	0.0	-11.0	-11.1	0.0	0.0
	MX	-2.9	-3.9	5.0	5.5	0.5	-1.9	-3.5	-5.0
	QY	2.9	3.1	-4.0	-3.9	-0.4	1.7	2.7	4.0
	MU	-2.4	-4.0	0.1	0.9	-1.9	0.5	-2.5	-2.9
	QX	-1.0	-1.8	0.2	0.8	1.8	0.3	-0.5	-0.3
8	N	0.0	0.0	0.0	0.0	0.0	14.9	0.0	0.0
	MX	0.0	0.0	0.0	0.0	0.0	0.0	0.0	0.0
	QY	0.0	0.0	0.0	0.0	0.0	0.0	0.0	0.0
	MU	-0.2	-0.3	-0.3	-0.5	-0.2	-0.5	-0.3	-0.3
	QX	-0.1	-0.2	-0.2	-0.3	-0.2	-0.3	-0.2	-0.2
9	N	0.0	0.0	0.0	0.0	10.1	0.0	0.0	0.0
	MX	-0.1	0.2	0.2	0.3	0.3	0.2	0.2	0.2
	QY	-0.1	-0.1	-0.1	-0.2	-0.2	-0.1	-0.1	-0.2
	MU	0.0	0.0	0.0	0.0	0.0	0.0	0.0	0.0
	QX	0.0	0.0	0.0	0.0	0.0	0.0	0.0	0.0
14	N	89.6	125.4	110.5	166.2	64.6	63.2	88.2	115.7
	MX	-0.6	0.0	1.2	0.0	0.7	0.0	0.0	-1.2
	QY	0.4	0.0	-1.0	0.0	-0.3	0.0	0.0	0.8
	MU	-1.0	-1.5	0.0	0.0	0.0	-0.8	0.0	0.0
	QX	0.8	1.3	0.0	0.0	0.0	-0.4	0.0	0.0
ЯРУС 2 СЕЧЕНИЕ 2									
1	N	0.0	0.0	0.0	0.0	11.0	11.1	0.0	0.0
	MX	-4.0	-3.5	4.6	3.9	0.3	-2.2	-3.0	-4.6
	QY	-2.9	-3.1	4.0	3.9	0.4	-1.7	-2.7	-4.0
	MU	3.2	-3.6	0.5	0.9	-2.3	0.3	-2.1	2.5
	QX	1.0	1.8	-0.2	-0.8	-1.8	-0.3	0.5	0.3
8	N	0.0	0.0	0.0	0.0	0.0	-14.9	0.0	0.0
	MX	0.0	0.0	0.0	0.0	0.0	0.0	0.0	0.0
	QY	0.0	0.0	0.0	0.0	0.0	0.0	0.0	0.0
	MU	-0.1	-0.3	-0.2	-0.2	-0.2	-0.3	-0.1	-0.2
	QX	0.1	0.3	0.2	0.3	0.2	0.3	0.2	0.2
9	N	0.0	0.0	0.0	0.0	-10.1	0.0	0.0	0.0
	MX	0.1	0.1	0.1	0.1	0.2	0.1	0.1	0.3
	QY	0.1	0.1	0.1	0.2	0.2	0.1	0.1	0.2
	MU	0.0	0.0	0.0	0.0	0.0	0.0	0.0	0.0
	QX	0.0	0.0	0.0	0.0	0.0	0.0	0.0	0.0
14	N	-89.6	-125.4	-110.5	-166.2	-64.6	-63.2	-88.2	-115.7
	MX	0.5	-0.1	1.1	0.0	0.1	0.0	0.0	-0.6
	QY	0.4	0.0	1.0	0.0	0.3	0.0	0.0	-0.8
	MU	1.0	1.9	0.0	0.0	0.0	-0.2	0.0	0.0
	QX	0.8	1.3	0.0	0.0	0.0	-0.3	0.6	0.6

ИВ № ПОДЛ
ПОДПИСЬ И ДАТА
ВЗАМ. ИВ №

1.220.1-3Ж.0-1.6 21МУЗ		ЛИСТ
		2

23171-04 44 ФОРМАТ А4

Номер загрузки	Тип усилия	Номер группы элементов							
		1	2	3	4	5	6	7	8
ЯРУС 3 СЕЧЕНИЕ 1									
1	N	0.0	0.0	0.0	0.0	-3.8	-3.8	0.0	0.0
	MX	4.0	3.5	-4.6	-3.9	0.2	1.5	3.0	4.6
	QY	-1.4	-1.2	1.7	1.4	-0.1	-0.6	-0.9	-1.6
	MU	-3.2	3.6	-0.5	-0.9	1.5	0.2	2.1	-2.5
	QX	0.7	0.8	-0.2	-0.4	-0.6	0.1	0.2	0.2
8	N	0.0	0.0	0.0	0.0	0.0	-8.9	0.0	0.0
	MX	0.0	0.0	0.0	0.0	0.0	0.0	0.0	0.0
	QY	0.0	0.0	0.0	0.0	0.0	0.0	0.0	0.0
	MU	0.1	0.3	0.2	0.2	0.1	-0.2	0.1	0.2
	QX	0.1	0.3	0.1	0.1	0.0	-0.1	0.0	0.1
9	N	0.0	0.0	0.0	0.0	6.0	0.0	0.0	0.0
	MX	-0.1	-0.1	-0.1	-0.1	0.2	-0.1	-0.1	-0.3
	QY	0.0	0.0	0.0	0.1	-0.1	0.0	0.0	0.3
	MU	0.0	0.0	0.0	0.0	0.0	0.0	0.0	0.0
	QX	0.0	0.0	0.0	0.0	0.0	0.0	0.0	0.0
14	N	67.0	93.2	79.5	122.1	28.7	27.3	44.1	84.7
	MX	-0.4	0.1	0.9	0.0	0.4	0.1	0.0	1.3
	QY	0.3	-0.1	-0.6	0.0	-0.3	-0.1	0.0	-1.3
	MU	-0.9	-1.4	0.0	0.0	0.0	-0.3	0.0	0.0
	QX	0.5	-0.9	0.0	0.0	0.0	-0.2	0.0	0.0
ЯРУС 3 СЕЧЕНИЕ 2									
1	N	0.0	0.0	0.0	0.0	3.8	3.8	0.0	0.0
	MX	0.8	0.6	-1.0	-0.8	0.1	0.5	0.0	0.6
	QY	1.1	0.8	-1.7	-1.4	0.1	0.6	0.9	1.5
	MU	-0.6	0.7	-0.4	-0.4	0.6	0.1	0.0	-0.3
	QX	1.1	1.2	0.2	0.4	0.6	-0.1	-0.2	0.3
8	N	0.0	0.0	0.0	0.0	0.0	8.9	0.0	0.0
	MX	0.1	0.1	0.0	0.0	0.0	0.0	0.0	0.0
	QY	0.0	0.0	0.0	0.0	0.0	0.0	0.0	0.0
	MU	0.2	0.8	0.1	0.1	0.1	-0.2	0.0	0.2
	QX	-0.1	-0.3	-0.1	-0.1	0.0	0.1	0.0	-0.1
9	N	0.0	0.0	0.0	0.0	-6.0	0.0	0.0	0.0
	MX	0.0	0.0	0.0	0.0	0.1	0.0	0.0	-0.8
	QY	0.0	0.0	0.0	-0.1	0.1	0.0	0.0	-0.3
	MU	0.0	0.0	0.0	0.0	0.0	0.0	0.0	0.0
	QX	0.0	0.0	0.0	0.0	0.0	0.0	0.0	0.0
14	N	-67.0	-93.2	-79.5	-122.1	-28.7	-27.3	-44.1	-84.7
	MX	-0.7	0.4	1.2	0.0	0.5	0.2	0.0	3.0
	QY	-0.3	0.1	0.6	0.0	0.3	0.1	0.0	1.3
	MU	1.0	-1.6	0.0	0.1	0.0	-0.4	0.0	0.0
	QX	0.5	-0.9	0.0	0.0	0.0	0.2	0.0	0.0

1.220.1-3М.0-1.4 21МУ3

ЛИСТ
3

Номер загрузки	Тип усилия	Номер группы элементов							
		1	2	3	4	5	6	7	8
ЯРУС 4 СЕЧЕНИЕ 1									
1	N	0.0	0.0	0.0	0.0	-0.8	-0.7	0.0	0.0
	MX	-0.8	-0.6	1.0	0.8	0.1	-0.1	0.0	-0.6
	QY	0.3	0.2	-0.3	-0.3	0.0	0.0	0.0	0.1
	MU	0.6	-0.7	0.4	0.4	0.0	-0.1	0.0	0.3
	QX	0.2	0.1	0.1	0.1	0.0	0.0	0.0	0.0
8	N	0.0	0.0	0.0	0.0	0.0	4.5	0.0	0.0
	MX	-0.1	-0.1	0.0	0.0	0.0	0.0	0.0	0.0
	QY	-0.0	0.0	0.0	0.0	0.0	0.0	0.0	0.0
	MU	-0.2	-0.8	-0.1	-0.1	0.0	-0.2	0.0	-0.2
	QX	-0.1	-0.4	-0.1	0.0	0.0	-0.1	0.0	-0.1
9	N	0.0	0.0	0.0	0.0	3.0	0.1	0.0	0.0
	MX	0.0	0.0	0.0	0.0	0.1	0.0	0.0	0.8
	QY	0.0	0.0	0.0	0.0	-0.1	0.0	0.0	-0.5
	MU	0.0	0.0	0.0	0.0	0.0	0.0	0.0	0.0
	QX	0.0	0.0	0.0	0.0	0.0	0.0	0.0	0.0
14	N	44.3	60.9	48.4	78.0	15.7	12.3	0.0	53.6
	MX	0.5	-0.4	0.7	0.0	-0.8	-0.2	0.0	-1.1
	QY	-0.3	0.5	-0.2	0.0	0.5	0.2	0.0	1.2
	MU	-0.9	2.3	0.0	-0.1	0.0	-0.7	0.0	0.0
	QX	-0.5	0.7	0.0	0.0	0.0	-0.4	0.0	0.0
ЯРУС 4 СЕЧЕНИЕ 2									
1	N	0.0	0.0	0.0	0.0	0.8	0.7	0.0	0.0
	MX	0.2	0.1	0.2	0.1	0.0	-0.1	0.0	0.3
	QY	0.3	0.2	0.3	0.3	0.0	0.0	0.0	-0.1
	MU	0.1	0.2	0.1	0.1	0.0	0.0	0.0	0.1
	QX	0.2	0.1	-0.1	-0.1	0.0	0.0	0.0	0.0
8	N	0.0	0.0	0.0	0.0	0.0	-4.5	0.0	0.0
	MX	-0.1	0.1	0.0	0.0	0.0	0.0	0.0	0.0
	QY	0.0	0.0	0.0	0.0	0.0	0.0	0.0	0.0
	MU	-0.2	-1.0	-0.1	0.0	0.1	-0.1	0.0	-0.2
	QX	0.1	0.5	0.1	0.0	0.0	0.1	0.0	0.1
9	N	0.0	0.0	0.0	0.0	-3.0	-0.1	0.0	0.0
	MX	0.0	0.0	0.0	0.0	0.1	0.0	0.0	1.0
	QY	0.0	0.0	0.0	0.0	0.1	0.0	0.0	0.5
	MU	0.0	0.0	0.0	0.0	0.0	0.0	0.0	0.0
	QX	0.0	0.0	0.0	0.0	0.0	0.0	0.0	0.0
14	N	-44.3	-60.9	-48.4	-78.0	-15.7	-12.3	0.0	-53.6
	MX	-0.9	-1.4	-0.1	0.0	-0.9	0.5	0.0	2.9
	QY	-0.2	-0.5	0.2	0.0	-0.5	0.2	0.0	1.2
	MU	-0.7	2.3	-0.1	-0.1	0.1	-0.7	0.0	0.0
	QX	-0.4	0.7	0.0	0.0	0.0	-0.4	0.0	0.0

1.220.1-3М.0-1.4 21МУ3

ЛИСТ
4

1.220.1-3М.0-1.4 21МУ3

Безуглова
Безуглова
ОПЕРАТОР
СИСТЕМ
САПР
КиевНИИЭП

ИНВ № ПОДЛ
ПОДПИСЬ И ДАТА
ВЗАМ ИНВ №

Номер загрузки	Тип усилия	Номер группы элементов							
		1	2	3	4	5	6	7	8
ЯРУС 1 СЕЧЕНИЕ 1									
1	N	0.0	0.0	0.0	0.0	-20.6	-20.3	0.0	0.0
	MX	-6.3	-7.8	10.3	11.7	-22.6	-8.6	-7.0	-10.3
	QY	1.4	1.6	-2.1	-2.2	11.2	2.0	1.4	2.1
	MY	-4.9	-7.8	1.2	3.0	-8.7	-22.4	-4.6	-5.3
	QX	-0.6	-1.0	0.3	0.6	2.0	-11.1	-0.4	-0.3
8	N	0.0	0.0	0.0	0.0	0.1	41.1	0.0	0.0
	MX	0.0	0.0	0.0	0.0	0.1	0.0	0.0	0.0
	QY	0.0	0.0	0.0	0.0	0.0	0.0	0.0	0.0
	MY	-1.1	-2.1	-1.9	-3.3	-4.2	-17.0	-1.9	-1.9
	QX	-0.2	-0.4	-0.4	-0.6	-0.9	-8.4	-0.4	-0.4
9	N	0.0	0.0	0.0	0.0	-27.8	0.0	0.0	0.0
	MX	0.8	1.3	1.3	2.2	11.4	2.8	1.3	1.5
	QY	-0.2	-0.3	-0.3	-0.4	-5.7	-0.6	-0.3	-0.3
	MY	0.0	0.0	0.0	0.0	0.0	0.0	0.0	0.0
	QX	0.0	0.0	0.0	0.0	0.0	0.0	0.0	0.0
14	N	117.1	159.4	143.3	204.5	173.1	169.5	126.5	148.5
	MX	0.5	-0.1	1.1	0.0	-5.3	0.0	0.0	-0.7
	QY	-0.4	0.0	-0.8	0.0	3.7	0.0	0.0	0.7
	MY	1.0	1.9	0.0	0.0	0.0	5.6	0.0	0.0
	QX	-0.7	-1.1	0.0	0.0	0.0	3.8	0.0	0.0
ЯРУС 1 СЕЧЕНИЕ 2									
1	N	0.0	0.0	0.0	0.0	20.6	20.3	0.0	0.0
	MX	0.7	1.5	-1.9	-2.7	-22.1	0.6	1.4	2.0
	QY	-1.4	-1.6	2.1	2.2	-11.2	-2.0	-1.4	-2.1
	MY	0.6	1.5	-0.1	-0.6	0.6	-21.9	0.9	1.1
	QX	0.6	1.0	-0.3	-0.6	-2.0	11.1	0.4	0.3
8	N	0.0	0.0	0.0	0.0	-0.1	-41.1	0.0	0.0
	MX	0.0	0.0	0.0	0.0	0.1	0.0	0.0	0.0
	QY	0.0	0.0	0.0	0.0	0.0	0.0	0.0	0.0
	MY	0.2	0.4	0.4	0.8	0.5	-16.8	0.4	0.4
	QX	0.2	0.4	0.4	0.6	0.9	8.4	0.4	0.4
9	N	0.0	0.0	0.0	0.0	27.8	0.0	0.0	0.0
	MX	-0.1	-0.3	-0.3	-0.5	11.3	-0.4	-0.3	-0.3
	QY	0.2	0.3	0.3	0.4	5.7	0.6	0.3	0.3
	MY	0.0	0.0	0.0	0.0	0.0	0.0	0.0	0.0
	QX	0.0	0.0	0.0	0.0	0.0	0.0	0.0	0.0
14	N	-117.1	-159.4	-143.3	-204.5	-173.1	-169.5	-126.5	-148.5
	MX	0.9	0.0	2.2	0.0	-9.7	0.0	0.0	2.1
	QY	0.4	0.0	0.8	0.0	-3.7	0.0	0.0	0.7
	MY	1.7	2.9	0.0	0.0	0.0	10.1	0.0	0.0
	QX	0.7	-1.1	0.0	0.0	0.0	-3.8	0.0	0.0

1.220.1-3М.0-1.4 21МУ4

ГИП	Егулов		СТАДИЯ	ЛИСТ	ЛИСТОВ
И.КОНТР	Бойко	<i>Бойко</i>	Р	1	4
РУК.ГР	Рудавик	<i>Рудавик</i>	ГОСГРАЖДАНСТРОЙ КиевЗНИИЭП		
ПРОВЕРИЛ	Футорная	<i>Футорная</i>			
РАЗРАБ	Эуежко	<i>Эуежко</i>			

ЗДАНИЕ
4Т 6.4.30-ЗАЛ(2*12)40-4.0

ФОРМАТ А4

Номер загрузки	Тип усилия	Номер группы элементов							
		1	2	3	4	5	6	7	8
ЯРУС 2 СЕЧЕНИЕ 1									
1	N	0.0	0.0	0.0	0.0	3.5	3.5	0.0	0.0
	MX	-0.7	-1.5	1.9	2.7	0.5	-0.8	-1.4	-2.0
	QY	1.4	1.6	-2.1	-2.2	-0.4	0.9	1.4	2.1
	MY	-0.6	-1.5	0.1	0.6	-0.8	0.4	-0.9	-1.1
	QX	-0.6	-1.0	0.3	0.6	0.9	0.3	-0.4	-0.3
8	N	0.0	0.0	0.0	0.0	0.0	13.1	0.0	0.0
	MX	0.0	0.0	0.0	0.0	0.0	0.0	0.0	0.0
	QY	0.0	0.0	0.0	0.0	0.0	0.0	0.0	0.0
	MY	-0.2	-0.4	-0.4	-0.8	-0.4	-0.2	-0.4	-0.4
	QX	-0.2	-0.4	-0.4	-0.6	-0.4	-0.2	-0.4	-0.4
9	N	0.0	0.0	0.0	0.0	8.9	0.0	0.0	0.0
	MX	-0.1	0.3	0.3	0.5	0.2	0.3	0.3	0.3
	QY	-0.2	-0.3	-0.3	-0.4	-0.1	-0.3	-0.3	-0.3
	MY	0.0	0.0	0.0	0.0	0.0	0.0	0.0	0.0
	QX	0.0	0.0	0.0	0.0	0.0	0.0	0.0	0.0
14	N	89.6	125.4	110.5	166.2	72.8	71.6	88.2	115.7
	MX	-0.5	0.0	1.0	0.0	1.0	0.0	0.0	-1.1
	QY	0.3	0.0	-0.8	0.0	-0.6	0.0	0.0	0.7
	MY	-0.8	-1.2	0.0	0.0	0.0	-1.1	0.0	0.0
	QX	0.7	1.1	0.0	0.0	0.0	-0.6	0.0	0.0
ЯРУС 2 СЕЧЕНИЕ 2									
1	N	0.0	0.0	0.0	0.0	-3.5	-3.5	0.0	0.0
	MX	-2.6	-2.2	3.0	2.6	0.4	-1.4	-2.0	-3.0
	QY	-1.4	-1.6	2.1	2.2	0.4	-0.9	-1.4	-2.1
	MY	-2.0	-2.2	0.5	0.8	-1.4	0.4	-1.3	-1.5
	QX	0.6	1.0	-0.3	-0.6	-0.9	-0.3	0.4	0.3
8	N	0.0	0.0	0.0	0.0	0.0	-13.1	0.0	0.0
	MX	0.0	0.0	0.0	0.0	0.0	0.0	0.0	0.0
	QY	0.0	0.0	0.0	0.0	0.0	0.0	0.0	0.0
	MY	-0.4	-0.6	-0.5	-0.7	-0.6	-0.2	-0.5	-0.5
	QX	0.2	0.4	0.4	0.6	0.4	0.2	0.4	0.4
9	N	0.0	0.0	0.0	0.0	-8.9	0.0	0.0	0.0
	MX	0.3	0.3	0.3	0.4	0.1	0.4	0.3	0.5
	QY	0.2	0.3	0.3	0.4	0.1	0.3	0.3	0.3
	MY	0.0	0.0	0.0	0.0	0.0	0.0	0.0	0.0
	QX	0.0	0.0	0.0	0.0	0.0	0.0	0.0	0.0
14	N	-89.6	-125.4	-110.5	-166.2	-72.8	-71.6	-88.2	-115.7
	MX	0.4	-0.1	1.0	0.0	0.3	0.0	0.0	-0.6
	QY	0.4	0.0	0.8	0.0	0.6	0.0	0.0	-0.7
	MY	0.9	1.7	0.0	0.0	0.0	-0.4	0.0	0.0
	QX	0.7	1.1	0.0	0.0	0.0	-0.5	0.0	0.0

1.220.1-3М.0-1.4 21МУ4

ЛИСТ

2

23171-04 46

ФОРМАТ А4

Номер загрузки	Тип усилия	Номер группы элементов							
		1	2	3	4	5	6	7	8
ЯРУС 3 СЕЧЕНИЕ 1									
1	N	0.0	0.0	0.0	0.0	2.0	2.0	0.0	0.0
	MX	2.6	2.2	-3.0	-2.6	0.1	1.0	2.0	3.0
	QY	-0.9	-0.8	1.1	1.0	-0.1	-0.4	-0.6	-1.0
	MU	2.0	2.2	-0.5	-0.8	1.0	0.1	1.3	1.5
	QX	0.5	0.6	-0.2	-0.3	-0.4	0.0	0.2	0.2
8	N	0.0	0.0	0.0	0.0	0.0	-8.7	0.0	0.0
	MX	0.0	0.0	0.0	0.0	0.0	0.0	0.0	0.0
	QY	0.0	0.0	0.0	0.0	0.0	0.0	0.0	0.0
	MU	0.4	0.6	0.5	0.7	0.4	-0.2	0.5	0.5
	QX	0.2	0.4	0.2	0.2	0.2	-0.1	0.1	0.2
9	N	0.0	0.0	0.0	0.0	5.9	0.0	0.0	0.0
	MX	-0.3	-0.3	-0.3	-0.4	0.1	-0.3	-0.3	-0.5
	QY	0.1	0.1	0.1	0.2	-0.1	0.1	0.1	0.4
	MU	0.0	0.0	0.0	0.0	0.0	0.0	0.0	0.0
	QX	0.0	0.0	0.0	0.0	0.0	0.0	0.0	0.0
14	N	67.0	93.2	79.5	122.1	30.9	29.7	44.1	84.7
	MX	-0.5	0.1	1.0	0.0	0.3	0.1	0.0	1.4
	QY	0.4	-0.1	-0.7	0.0	-0.2	-0.1	0.0	-1.3
	MU	-1.0	-1.6	0.0	0.0	0.0	-0.2	0.0	0.0
	QX	0.6	-1.0	0.0	0.0	0.0	-0.2	0.0	0.0
ЯРУС 3 СЕЧЕНИЕ 2									
1	N	0.0	0.0	0.0	0.0	-2.0	-2.0	0.0	0.0
	MX	0.5	0.4	-0.6	-0.6	0.1	0.4	0.0	0.4
	QY	0.8	0.6	-1.1	-1.0	0.1	0.4	-0.5	1.0
	MU	-0.4	0.5	-0.2	-0.3	0.4	0.1	0.0	-0.2
	QX	0.7	0.8	0.2	0.3	0.4	0.0	-0.1	0.2
8	N	0.0	0.0	0.0	0.0	0.0	8.7	0.0	0.0
	MX	0.1	0.1	0.0	0.0	0.0	0.0	0.0	0.0
	QY	0.0	0.0	0.0	0.0	0.0	0.0	0.0	0.0
	MU	0.2	0.8	0.1	0.2	0.2	-0.2	0.0	0.2
	QX	-0.2	-0.4	-0.2	-0.2	-0.2	0.1	-0.1	-0.2
9	N	0.0	0.0	0.0	0.0	-5.9	0.0	0.0	0.0
	MX	-0.1	-0.1	-0.1	-0.1	0.1	-0.1	0.0	-0.8
	QY	-0.1	-0.1	-0.1	-0.2	0.1	-0.1	-0.1	-0.4
	MU	0.0	0.0	0.0	0.0	0.0	0.0	0.0	0.0
	QX	0.0	0.0	0.0	0.0	0.0	0.0	0.0	0.0
14	N	-67.0	-93.2	-79.5	-122.1	-30.9	-29.7	-44.1	-84.7
	MX	-0.7	0.4	1.2	0.0	0.5	0.2	0.0	3.0
	QY	-0.4	0.1	0.7	0.0	0.2	0.1	0.0	1.3
	MU	1.0	-1.7	0.0	0.1	0.0	-0.4	0.0	0.0
	QX	0.6	-1.0	0.0	0.0	0.0	0.2	0.0	0.0

ЛИСТ
3

1.220.1-3М.0-1.4 21МУ4

ФОРМАТ А4

Номер загрузки	Тип усилия	Номер группы элементов							
		1	2	3	4	5	6	7	8
ЯРУС 4 СЕЧЕНИЕ 1									
1	N	0.0	0.0	0.0	0.0	0.4	0.4	0.0	0.0
	MX	-0.5	-0.4	0.6	0.6	0.0	0.0	0.0	-0.4
	QY	0.2	0.1	-0.2	-0.2	0.0	0.0	0.0	0.1
	MU	0.4	-0.5	0.2	0.3	0.0	0.0	0.0	0.2
	QX	0.1	0.0	0.1	0.1	0.0	0.0	0.0	0.0
8	N	0.0	0.0	0.0	0.0	0.0	4.4	0.0	0.0
	MX	-0.1	-0.1	0.0	0.0	0.0	0.0	0.0	0.0
	QY	0.1	0.0	0.0	0.0	0.0	0.0	0.0	0.0
	MU	-0.2	-0.8	-0.1	-0.2	0.0	-0.2	0.0	-0.2
	QX	-0.1	-0.4	-0.1	-0.1	0.0	-0.1	0.0	-0.1
9	N	0.0	0.0	0.0	0.0	3.0	0.1	0.0	0.0
	MX	0.1	0.1	0.1	0.1	0.1	0.0	0.0	0.8
	QY	0.0	0.0	0.0	0.0	-0.1	0.0	0.0	-0.5
	MU	0.0	0.0	0.0	0.0	0.0	0.0	0.0	0.0
	QX	0.0	0.0	0.0	0.0	0.0	0.0	0.0	0.0
14	N	44.3	60.9	48.4	78.0	16.1	12.8	0.0	53.6
	MX	0.4	-0.4	0.7	0.0	-0.8	-0.2	0.0	-1.1
	QY	-0.3	0.5	-0.2	0.0	0.5	0.2	0.0	1.2
	MU	-0.9	2.3	0.0	-0.1	0.0	-0.6	0.0	0.0
	QX	-0.5	0.7	0.0	0.0	0.0	-0.4	0.0	0.0
ЯРУС 4 СЕЧЕНИЕ 2									
1	N	0.0	0.0	0.0	0.0	-0.4	-0.4	0.0	0.0
	MX	0.1	0.1	0.1	0.1	0.0	0.0	0.0	0.2
	QY	0.2	0.1	0.2	0.2	0.0	0.0	0.0	-0.1
	MU	0.1	0.2	0.0	0.0	0.0	0.0	0.0	0.1
	QX	0.1	0.0	-0.1	-0.1	0.0	0.0	0.0	0.0
8	N	0.0	0.0	0.0	0.0	0.0	-4.4	0.0	0.0
	MX	-0.1	-0.1	0.0	0.0	0.0	0.0	0.0	0.0
	QY	-0.1	0.0	0.0	0.0	0.0	0.0	0.0	0.0
	MU	-0.2	-1.0	-0.1	-0.1	0.0	-0.1	0.0	-0.2
	QX	0.1	0.4	0.1	0.1	0.0	0.1	0.0	0.1
9	N	0.0	0.0	0.0	0.0	-3.0	-0.1	0.0	0.0
	MX	0.0	0.0	0.0	0.0	0.1	0.0	0.0	1.0
	QY	0.0	0.0	0.0	0.0	0.1	0.0	0.0	0.5
	MU	0.0	0.0	0.0	0.0	0.0	0.0	0.0	0.0
	QX	0.0	0.0	0.0	0.0	0.0	0.0	0.0	0.0
14	N	-44.3	-60.9	-48.4	-78.0	-16.1	-12.8	0.0	-53.6
	MX	-0.9	-1.4	-0.1	0.0	-0.9	0.5	0.0	2.9
	QY	-0.2	-0.5	0.2	0.0	-0.5	0.2	0.0	1.2
	MU	-0.7	2.3	-0.1	-0.1	0.1	-0.7	0.0	0.0
	QX	-0.4	0.7	0.0	0.0	0.0	-0.4	0.0	0.0

ЛИСТ
4

1.220.1-3М.0-1.4 21МУ4

23171-04 47

ФОРМАТ А4

Безупомятливо
ОПЕРАТОР СИСТЕМ
САПР КиевЗНИИЭП

Номер загрузки	Тип усилия	Номер группы элементов								
		1	2	3	4	5	6	7	8	
ЯРУС 1 СЕЧЕНИЕ 1										
1	N	0.0	0.0	0.0	0.0	-13.5	-12.3	0.0	0.0	
	MX	2.6	2.4	4.6	4.1	-11.2	4.6	-0.9	-2.8	
	QY	-0.8	-0.6	-1.1	-0.9	6.4	-1.3	0.2	0.7	
	MU	2.7	4.7	2.8	4.9	-6.0	8.8	1.9	2.8	
8	N	0.0	0.0	0.0	0.0	-0.5	-26.4	0.0	0.0	
	MX	-0.1	-0.1	-0.1	-0.1	0.2	-0.1	0.0	0.0	
	QY	0.0	0.0	0.0	0.0	-0.1	0.1	0.0	0.0	
	MU	-0.5	-0.9	-0.8	-1.6	-1.9	-7.6	-0.6	-0.8	
9	N	0.0	0.0	0.0	0.0	29.3	3.0	0.0	0.0	
	MX	1.1	1.8	1.5	2.6	12.3	1.7	1.3	-0.1	
	QY	-0.4	-0.5	-0.4	-0.6	-7.0	0.1	-0.2	-0.4	
	MU	0.6	0.3	0.7	0.5	-0.7	-1.1	0.1	-0.6	
14	N	104.6	138.8	137.4	175.5	128.6	130.7	82.4	117.4	
	MX	0.9	-0.3	1.9	0.6	2.0	-2.2	0.1	-2.4	
	QY	-0.6	-0.2	-1.4	-0.2	-1.5	1.5	0.0	1.5	
	MU	-1.2	-1.9	-0.1	-0.1	-1.7	2.1	0.0	0.0	
1	N	0.0	0.0	0.0	0.0	13.5	12.3	0.0	0.0	
	MX	-0.1	-0.4	-0.7	-0.9	-11.1	0.5	0.4	0.5	
	QY	-0.6	0.5	1.1	0.8	-6.4	-0.7	-0.2	-0.7	
	MU	0.1	0.6	0.4	-1.0	-0.6	8.8	-0.8	-0.4	
8	N	0.0	0.0	0.0	0.0	0.5	26.4	0.0	0.0	
	MX	-0.1	-0.1	-0.1	-0.1	0.2	-0.2	0.0	0.0	
	QY	0.0	0.0	0.0	0.0	0.1	-0.1	0.0	0.0	
	MU	0.1	0.2	0.2	0.4	0.5	-7.8	0.3	0.2	
9	N	0.0	0.0	0.0	0.0	-29.3	-3.0	0.0	0.0	
	MX	-1.0	-1.2	-0.9	-1.2	12.1	-2.4	-0.5	-1.2	
	QY	-0.4	-0.3	-0.1	0.0	7.0	-0.3	0.2	-0.4	
	MU	0.5	0.2	0.5	0.2	-0.9	-1.0	0.0	-0.4	
14	N	-104.6	-138.8	-137.4	-175.5	-128.6	-130.7	-82.4	-117.4	
	MX	1.3	-0.5	3.0	-1.0	3.3	-3.1	0.0	-2.7	
	QY	0.6	-0.2	1.4	-0.4	1.5	-1.5	0.0	-1.5	
	MU	-1.8	-3.0	0.0	0.0	-2.5	3.6	0.0	0.0	
1.220.1-3М.0-1.4 22МУ1										
ГИП	Егунов							СТАДИЯ	ЛИСТ	ЛИСТОВ
И.КОНТР	Бойко							Р	1	3
РУК.ГР.	Рудакин							ЗДАНИЕ		
ПРОВЕРИЛ	Футорная							ГОСГРАЖДАНСТРОЙ		
РАЗРАБ	Эуенко							КиевЗНИИЭП		
37 4.5.30-ЗАЛ(12)32-3.5										

Номер загрузки	Тип усилия	Номер группы элементов								
		1	2	3	4	5	6	7	8	
ЯРУС 2 СЕЧЕНИЕ 1										
1	N	0.0	0.0	0.0	0.0	2.4	1.5	0.0	0.0	
	MX	0.1	0.4	0.7	0.9	0.3	0.5	-0.4	-0.5	
	QY	-0.6	-0.5	-1.1	-0.8	-0.2	-0.6	0.2	0.7	
	MU	-0.1	-0.6	-0.4	1.0	-0.6	-0.2	0.8	0.4	
8	N	0.0	0.0	0.0	0.0	-0.4	11.1	0.0	0.0	
	MX	0.1	0.1	0.1	0.1	0.0	0.0	0.0	0.0	
	QY	0.0	0.0	0.0	0.0	0.0	0.0	0.0	0.0	
	MU	-0.1	-0.2	-0.2	-0.4	-0.2	-0.4	-0.3	-0.2	
9	N	0.0	0.0	0.0	0.0	8.8	2.8	0.0	0.0	
	MX	1.0	1.2	0.9	1.2	-0.7	0.3	0.5	1.2	
	QY	0.4	0.3	0.1	0.0	0.6	-0.1	-0.2	0.4	
	MU	-0.5	-0.2	-0.5	-0.2	-0.1	0.2	0.0	0.4	
14	N	74.3	102.2	101.5	134.0	54.1	65.8	44.1	81.7	
	MX	0.9	-0.3	1.7	-0.5	0.5	0.8	0.0	-0.6	
	QY	-0.6	0.2	-1.4	0.4	-0.2	-0.6	0.0	1.5	
	MU	1.1	1.5	0.0	0.0	-0.7	-0.7	0.0	0.0	
1	N	0.0	0.0	0.0	0.0	-2.4	-1.5	0.0	0.0	
	MX	1.6	1.1	2.1	1.3	0.2	0.9	0.0	-1.1	
	QY	0.8	0.6	1.1	0.9	0.2	0.6	-0.2	-0.7	
	MU	2.0	2.2	1.4	1.6	-1.5	-0.2	0.0	1.3	
8	N	0.0	0.0	0.0	0.0	0.4	-11.1	0.0	0.0	
	MX	-0.2	-0.2	-0.1	-0.1	0.0	-0.1	0.0	-0.1	
	QY	0.0	0.0	0.0	0.0	0.0	0.0	0.0	0.0	
	MU	-0.2	-0.3	-0.3	-0.4	-0.4	-0.3	0.0	-0.3	
9	N	0.0	0.0	0.0	0.0	-8.8	-2.8	0.0	0.0	
	MX	-1.9	-1.9	-1.3	-1.2	-0.7	-1.0	0.0	-2.1	
	QY	-0.4	-0.3	-0.1	0.0	-0.6	-0.3	0.2	-0.4	
	MU	1.3	0.6	1.4	0.6	-0.8	0.3	0.0	-1.2	
14	N	-74.3	-102.2	-101.5	-134.0	-54.1	-65.8	-44.1	-84.7	
	MX	0.7	-0.3	1.6	0.5	-1.1	-1.1	0.0	-2.9	
	QY	0.6	-0.2	1.4	0.2	-0.6	-0.7	0.0	-1.5	
	MU	-0.9	-1.8	-0.1	-0.1	-0.9	-1.2	0.0	0.0	
1.220.1-3М.0-1.4 22МУ1										
ИНВ.№ ПОДЛ	ПОДПИСЬ И ДАТА	ВЗАМ.ИНВ.№								ЛИСТ
										2

Номер загрузки	Тип усилия	Номер группы элементов							
		1	2	3	4	5	6	7	8
ЯРУС 3 СЕЧЕНИЕ 1									
1	N	0.0	0.0	0.0	0.0	1.4	1.2	0.0	0.0
	MX	-1.8	-1.1	-2.1	-1.3	0.9	-3.0	0.0	1.1
	QU	0.7	0.4	0.8	0.5	-0.4	1.1	0.0	-0.2
	MU	-2.0	-2.2	-1.4	-1.6	-3.1	-0.5	0.0	-1.3
	QX	0.6	0.8	0.4	0.5	-1.2	-0.2	0.0	-0.5
8	N	0.0	0.0	0.0	0.0	-0.2	6.3	0.0	0.0
	MX	0.2	0.2	0.1	0.1	0.5	0.1	0.0	0.1
	QU	-0.1	-0.1	0.0	0.0	-0.2	0.0	0.0	0.0
	MU	0.2	0.3	0.3	0.4	-0.6	-0.6	0.0	0.3
	QX	0.1	0.1	0.1	0.1	0.1	-0.2	0.0	0.0
9	N	0.0	0.0	0.0	0.0	5.2	0.4	0.0	0.0
	MX	1.9	1.9	1.3	1.2	6.5	2.2	0.0	2.1
	QU	-0.2	-0.2	-0.1	-0.1	-1.9	-0.8	0.0	-0.7
	MU	-1.3	-0.6	-1.4	-0.6	0.9	-3.4	0.0	1.2
	QX	0.1	-0.1	-0.2	0.0	0.0	0.8	0.0	0.1
14	N	49.4	66.8	66.1	85.7	49.5	65.8	0.0	53.6
	MX	0.8	-0.4	1.4	-0.6	-2.0	1.7	0.0	1.0
	QU	-0.5	0.3	-0.9	0.4	1.2	-1.3	0.0	-1.2
	MU	1.1	1.6	0.1	0.1	-2.4	1.3	0.0	0.0
	QX	0.5	-0.8	0.1	0.0	-0.7	-0.4	0.0	0.0
ЯРУС 3 СЕЧЕНИЕ 2									
1	N	0.0	0.0	0.0	0.0	-1.4	-1.2	0.0	0.0
	MX	0.5	-0.2	-0.4	-0.3	0.4	-0.6	0.0	-0.5
	QU	0.6	-0.4	-0.8	-0.5	0.4	-1.1	0.0	0.2
	MU	-0.5	-0.5	-0.4	-0.4	0.8	-0.2	0.0	-0.3
	QX	0.7	-0.8	-0.4	-0.5	1.2	0.2	0.0	0.5
8	N	0.0	0.0	0.0	0.0	0.2	-6.3	0.0	0.0
	MX	0.1	0.1	0.0	0.0	0.1	0.0	0.0	0.0
	QU	0.0	0.0	0.0	0.0	0.2	0.0	0.0	0.0
	MU	-0.1	0.1	-0.1	0.1	-1.1	-0.3	0.0	-0.1
	QX	0.0	-0.1	-0.1	-0.1	-0.1	0.2	0.0	0.0
9	N	0.0	0.0	0.0	0.0	-5.2	-0.4	0.0	0.0
	MX	-1.4	-1.3	-1.0	-1.0	0.1	0.7	0.0	0.3
	QU	0.2	0.2	0.1	0.1	0.1	0.6	0.0	0.7
	MU	-0.8	-0.4	-0.8	0.3	-0.4	-0.3	0.0	-0.8
	QX	-0.1	0.1	0.2	0.1	0.0	-0.7	0.0	-0.1
14	N	-49.4	-66.8	-66.1	-85.7	-49.5	-65.8	0.0	-53.6
	MX	0.9	-0.5	1.6	-1.8	-2.0	2.6	0.0	3.0
	QU	0.5	-0.3	0.9	-0.7	-1.2	1.3	0.0	1.2
	MU	0.7	1.1	0.2	0.1	-2.2	0.5	0.0	-0.1
	QX	-0.5	0.8	-0.1	0.0	0.7	-0.4	0.0	0.0

1.220.1-3М.0-1.4 22МУ1

ЛИСТ
3

Номер загрузки	Тип усилия	Номер группы элементов							
		1	2	3	4	5	6	7	8
ЯРУС 1 СЕЧЕНИЕ 1									
1	N	0.0	0.0	0.0	0.0	-10.0	-5.2	0.0	0.0
	MX	7.5	6.5	12.0	9.5	-39.2	13.6	-2.0	-6.9
	QU	-2.2	-1.7	-3.2	-2.4	30.2	-3.5	0.4	1.8
	MU	7.4	11.8	7.2	10.4	-15.3	34.7	4.8	7.0
	QX	-2.0	-3.1	-1.8	-2.5	-4.4	-12.9	0.3	1.9
8	N	0.0	0.0	0.0	0.0	-0.7	-25.0	0.0	0.0
	MX	-0.1	-0.2	-0.1	-0.2	0.2	-0.1	0.0	-0.1
	QU	0.1	0.1	0.1	0.1	-0.2	0.1	0.0	0.0
	MU	-0.2	-0.4	-0.3	-0.6	-0.9	-6.4	-0.3	-0.3
	QX	0.0	-0.1	0.0	-0.1	-0.1	-5.4	-0.1	-0.1
9	N	0.0	0.0	0.0	0.0	27.9	3.6	0.0	0.0
	MX	-1.4	-1.7	-1.0	-1.4	10.2	0.7	0.7	-1.9
	QU	0.8	0.8	0.6	0.6	-8.2	0.1	-0.1	0.9
	MU	0.9	0.6	1.3	0.9	-1.0	-1.2	0.1	-1.3
	QX	-0.4	0.3	0.6	0.0	-0.6	-0.8	0.0	-0.5
14	N	104.6	138.8	137.4	175.5	120.1	123.8	82.4	117.4
	MX	0.6	-0.2	0.8	0.9	4.1	-1.8	0.1	-2.4
	QU	-0.7	0.3	-1.5	-0.3	-4.4	1.8	0.0	1.8
	MU	-0.7	-0.9	-0.3	-0.2	-1.2	4.9	0.1	0.1
	QX	-1.0	1.5	0.0	0.0	0.0	0.0	0.0	0.0
ЯРУС 1 СЕЧЕНИЕ 2									
1	N	0.0	0.0	0.0	0.0	10.0	5.2	0.0	0.0
	MX	-2.2	-2.2	-4.0	-3.4	-36.4	-4.8	1.0	2.5
	QU	2.0	1.5	3.1	2.4	-30.2	3.5	-0.4	-1.8
	MU	-2.1	-3.8	2.3	-3.6	-5.0	32.4	-2.3	-2.3
	QX	-2.2	-3.2	-2.0	2.5	4.4	-12.7	-0.3	-1.9
8	N	0.0	0.0	0.0	0.0	0.7	25.0	0.0	0.0
	MX	0.0	0.0	0.0	0.0	0.2	-0.1	0.0	0.0
	QU	-0.1	0.0	0.0	-0.1	0.2	-0.1	0.0	0.0
	MU	0.1	0.2	0.1	0.2	0.5	-7.1	0.2	0.1
	QX	0.0	0.1	0.0	0.1	0.1	5.4	0.1	0.1
9	N	0.0	0.0	0.0	0.0	-27.9	-3.6	0.0	0.0
	MX	-0.6	-0.4	-0.4	-0.4	10.4	-2.2	-0.4	-0.4
	QU	-0.7	-0.8	-0.6	0.3	8.2	-1.1	0.1	-0.9
	MU	0.2	0.0	0.1	-0.1	-0.6	-1.0	0.0	0.0
	QX	-0.5	-0.3	-0.6	-0.3	0.6	-0.1	0.0	0.5
14	N	-104.6	-138.8	-137.4	-175.5	-120.1	-123.8	-82.4	-117.4
	MX	1.3	-0.5	3.0	-1.0	7.0	-2.7	0.0	-2.1
	QU	0.7	-0.2	1.4	-0.4	4.4	-1.8	0.0	-1.8
	MU	-1.7	-2.9	0.0	0.0	-2.4	8.3	0.0	0.0
	QX	1.0	1.5	0.1	0.0	0.0	0.0	0.0	0.0

1.220.1-3М.0-1.4 22МУ2

ГИП	Егунов	<i>[Signature]</i>
И КОНТР	Бойко	<i>[Signature]</i>
РУК ГР	Рудакин	<i>[Signature]</i>
ПРОВЕРИЛ	Футорная	<i>[Signature]</i>
РАЗРАБ	Зуенко	<i>[Signature]</i>

ЗДАНИЕ
3Т 4.5.30-ЗАЛ(12)40-2.5

СТАДИЯ	ЛИСТ	ЛИСТОВ
Р	1	3
ГОСГРАЖДАНСТРОЙ КиевЗНИИЭП		

Номер загрузки	Тип усилия	Номер группы элементов							
		1	2	3	4	5	6	7	8
ЯРУС 2 СЕЧЕНИЕ 1									
1	N	0.0	0.0	0.0	0.0	-10.6	-9.7	0.0	0.0
	MX	2.2	2.2	4.0	3.4	0.5	2.0	-1.0	-2.5
	QV	-2.0	-1.5	-3.1	-2.4	-0.3	-1.6	0.4	1.8
	MV	2.1	3.8	-2.3	3.6	-2.1	-0.4	2.3	2.3
	QX	2.2	3.2	2.0	-2.5	-1.9	0.3	0.3	1.9
8	N	0.0	0.0	0.0	0.0	-0.4	10.8	0.0	0.0
	MX	0.0	0.0	0.0	0.0	0.0	0.0	0.0	0.0
	QV	0.1	0.0	0.0	0.1	0.0	0.1	0.0	0.0
	MV	-0.1	-0.2	-0.1	-0.2	-0.1	-0.4	-0.2	-0.1
	QX	0.0	-0.1	0.0	-0.1	-0.1	-0.3	-0.1	-0.1
9	N	0.0	0.0	0.0	0.0	9.2	2.7	0.0	0.0
	MX	0.6	0.4	0.4	0.4	-0.3	-0.2	0.4	0.4
	QV	0.7	0.8	0.6	-0.3	0.3	0.7	-0.1	0.9
	MV	-0.2	0.0	-0.1	0.1	-0.2	0.2	0.0	0.0
	QX	0.5	0.3	0.6	0.2	-0.1	0.0	0.0	-0.5
14	N	74.3	102.2	101.5	134.0	56.0	67.9	44.1	84.7
	MX	0.9	-0.5	1.7	-0.4	0.3	0.9	0.0	-1.1
	QV	-0.7	0.3	-1.5	0.4	-0.3	-0.7	0.0	1.8
	MV	1.1	1.6	0.0	0.0	-0.7	-0.4	0.0	0.0
	QX	0.9	1.5	0.0	0.0	-0.5	-0.6	0.0	0.0
ЯРУС 2 СЕЧЕНИЕ 2									
1	N	0.0	0.0	0.0	0.0	10.6	9.7	0.0	0.0
	MX	3.1	2.0	3.7	2.4	-0.3	1.9	0.0	-1.7
	QV	2.2	1.7	3.2	2.4	-0.2	1.6	-0.4	-1.8
	MV	3.2	3.8	2.4	2.8	-2.5	0.3	0.9	2.1
	QX	2.0	3.1	1.8	2.5	-1.7	-0.3	0.3	-1.9
8	N	0.0	0.0	0.0	0.0	0.4	-10.8	0.0	0.0
	MX	-0.2	-0.2	-0.1	-0.1	0.0	-0.1	0.0	-0.1
	QV	-0.1	-0.1	-0.1	-0.1	0.0	-0.1	0.0	0.0
	MV	0.1	0.0	0.1	-0.1	0.3	-0.3	0.0	0.0
	QX	0.0	0.1	0.0	0.1	0.1	0.3	0.1	0.1
9	N	0.0	0.0	0.0	0.0	-9.2	-2.7	0.0	0.0
	MX	-2.3	-2.4	-1.7	-1.8	-0.4	-1.5	0.0	-2.5
	QV	-0.6	-0.8	-0.6	-0.6	-0.3	-0.7	0.1	-0.9
	MV	1.3	0.6	1.4	0.7	-0.8	0.2	0.0	-1.2
	QX	0.4	-0.3	-0.6	0.0	0.1	0.0	0.0	0.5
14	N	-74.3	-102.2	-101.5	-134.0	-56.0	-67.9	-44.1	-84.7
	MX	0.9	-0.3	1.8	0.6	-0.9	-1.2	0.0	-3.2
	QV	0.7	-0.3	1.5	0.3	-0.5	-0.8	0.0	-1.8
	MV	-1.2	-2.3	-0.2	-0.1	-1.0	-1.1	0.0	0.0
	QX	1.0	-1.5	0.0	0.0	0.7	-0.5	0.0	0.0

ЛИСТ

1.220.1-3М.0-1.4 22МУ2

2

ФОРМАТ А4

Номер загрузки	Тип усилия	Номер группы элементов							
		1	2	3	4	5	6	7	8
ЯРУС 3 СЕЧЕНИЕ 1									
1	N	0.0	0.0	0.0	0.0	-3.5	-3.1	0.0	0.0
	MX	-3.1	-2.0	-3.7	-2.4	1.4	-3.8	0.0	1.7
	QV	1.1	0.7	1.4	0.9	-0.6	1.4	0.0	-0.3
	MV	-3.2	-3.8	-2.4	-2.8	-3.9	-0.8	0.0	-2.1
	QA	1.0	1.3	0.7	0.9	-0.3	-0.2	0.0	-0.8
8	N	0.0	0.0	0.0	0.0	-0.2	6.1	0.0	0.0
	MX	0.2	0.2	0.1	0.1	0.4	0.1	0.0	0.1
	QV	-0.1	-0.1	0.0	0.0	-0.1	0.0	0.0	0.0
	MV	-0.1	0.0	-0.1	0.1	-0.9	-0.5	0.0	0.0
	QX	0.0	0.0	0.0	0.0	0.0	-0.2	0.0	0.0
9	N	0.0	0.0	0.0	0.0	5.1	0.4	0.0	0.0
	MX	2.3	2.4	1.7	1.8	5.3	2.5	0.0	2.5
	QV	-0.3	-0.3	-0.2	-0.2	-1.5	-0.8	0.0	-0.8
	MV	-1.3	-0.6	-1.4	-0.7	0.8	-2.8	0.0	1.2
	QX	0.1	-0.1	-0.2	0.0	0.1	0.6	0.0	0.2
14	N	49.4	66.8	66.1	85.7	49.5	65.8	0.0	53.6
	MX	0.6	-0.4	1.3	-0.6	-1.9	1.9	0.0	1.2
	QV	-0.4	0.3	-0.8	0.7	1.2	-1.3	0.0	-1.2
	MV	0.8	1.4	0.2	0.1	-2.3	1.2	0.0	0.0
	QX	0.4	-0.7	0.1	0.0	-0.6	0.4	0.0	0.0
ЯРУС 3 СЕЧЕНИЕ 2									
1	N	0.0	0.0	0.0	0.0	3.5	3.1	0.0	0.0
	MX	0.8	-0.4	-0.8	-0.5	0.6	-0.8	0.0	-0.8
	QV	1.0	-0.7	-1.4	-0.9	0.6	0.2	0.0	0.3
	MV	-0.8	-0.9	-0.6	-0.7	1.0	-0.3	0.0	-0.5
	QX	1.1	-1.3	-0.7	-0.9	0.3	0.1	0.0	0.8
8	N	0.0	0.0	0.0	0.0	0.2	-6.1	0.0	0.0
	MX	0.0	0.0	0.0	0.0	0.0	0.0	0.0	0.0
	QV	0.0	0.0	0.0	0.0	0.1	0.0	0.0	0.0
	MV	-0.1	0.0	-0.1	0.0	-0.9	-0.2	0.0	-0.1
	QX	0.0	0.0	0.0	0.0	0.0	0.1	0.0	0.0
9	N	0.0	0.0	0.0	0.0	-5.1	-0.4	0.0	0.0
	MX	-1.3	-1.3	-1.0	-1.0	-0.4	0.5	0.0	0.1
	QV	0.3	0.3	0.2	0.2	1.5	0.7	0.0	0.8
	MV	0.7	-0.3	-0.7	0.3	-0.4	-0.4	0.0	-0.7
	QX	0.2	0.1	0.2	0.1	-0.1	-0.6	0.0	-0.2
14	N	-49.4	-66.8	-66.1	-85.7	-49.5	-65.8	0.0	-53.6
	MX	0.9	-0.5	1.5	-1.8	-2.0	2.5	0.0	2.8
	QV	0.4	-0.3	0.8	-0.7	-1.2	1.3	0.0	1.2
	MV	0.7	1.1	0.2	0.1	-2.3	-0.5	0.0	-0.1
	QX	-0.4	0.7	-0.1	0.0	0.6	0.3	0.0	0.0

ЛИСТ

1.220.1-3М.0-1.4 22МУ2

3

23171-04 50

ФОРМАТ А4

Номер загрузки	Тип усилия	Номер группы элементов								
		1	2	3	4	5	6	7	8	
ЯРУС 1 СЕЧЕНИЕ 1										
1	N	0.0	0.0	0.0	0.0	-18.7	-16.1	0.0	0.0	
	MX	4.6	4.2	8.1	7.0	-20.6	8.3	-1.6	-5.0	
	QU	-1.0	-0.9	-1.6	-1.3	10.2	-1.7	0.2	1.0	
	MU	4.7	8.2	4.9	8.2	-10.2	16.3	3.5	4.9	
	QX	-1.0	-1.6	-0.9	-1.5	-2.3	-4.2	-0.2	1.0	
8	N	0.0	0.0	0.0	0.0	-0.6	-26.7	0.0	0.0	
	MX	-0.1	-0.2	-0.1	-0.2	0.3	-0.1	0.0	0.0	
	QU	0.0	0.1	0.0	0.0	-0.1	0.1	0.0	0.0	
	MU	-0.5	-1.0	-0.9	-1.7	-2.1	-9.0	-0.7	-0.9	
	QX	-0.1	-0.2	-0.1	-0.3	-0.2	-4.5	-0.1	-0.2	
9	N	0.0	0.0	0.0	0.0	-30.0	2.9	0.0	0.0	
	MX	1.3	2.2	1.8	2.9	14.9	1.8	1.5	-0.7	
	QU	-0.4	-0.5	-0.4	-0.6	-7.3	0.2	-0.2	0.5	
	MU	0.8	0.5	1.1	0.8	-1.0	-1.0	0.1	-1.0	
	QX	0.3	0.2	-0.3	0.2	-0.5	0.0	0.0	-0.3	
14	N	104.6	138.8	137.4	175.5	132.4	134.6	82.4	117.4	
	MX	1.0	-0.3	1.9	0.8	3.4	-2.4	0.1	-3.0	
	QU	-0.6	0.2	-1.3	-0.2	-2.3	1.5	0.0	1.4	
	MU	-1.2	-2.0	-0.2	-0.1	-1.9	3.8	0.0	0.0	
	QX	-0.8	1.3	0.0	0.0	0.0	0.0	0.0	0.0	
ЯРУС 1 СЕЧЕНИЕ 2										
1	N	0.0	0.0	0.0	0.0	18.7	16.1	0.0	0.0	
	MX	-0.6	-0.9	-1.6	-1.7	-20.3	-1.4	0.6	1.1	
	QU	1.0	0.8	1.6	1.3	-10.2	1.7	-0.2	-1.0	
	MU	0.6	1.5	0.9	-1.9	-1.7	16.6	-1.3	-1.0	
	QX	-1.1	-1.7	-1.0	-1.6	2.3	-4.2	0.2	-1.0	
8	N	0.0	0.0	0.0	0.0	0.6	26.7	0.0	0.0	
	MX	-0.1	-0.1	0.0	0.0	0.2	-0.2	0.0	0.0	
	QU	0.0	-0.1	0.0	0.0	0.1	-0.1	0.0	0.0	
	MU	0.1	0.2	0.3	0.4	0.6	-9.2	0.3	0.2	
	QX	0.1	0.2	0.1	0.3	0.2	4.5	0.1	0.2	
9	N	0.0	0.0	0.0	0.0	30.0	-2.9	0.0	0.0	
	MX	-1.1	-1.1	-0.9	-1.1	14.4	-3.0	-0.6	-1.2	
	QU	-0.4	-0.4	-0.2	-0.1	7.3	-0.4	0.2	-0.5	
	MU	0.5	0.2	0.4	0.1	-0.9	-0.9	0.0	-0.4	
	QX	-0.3	-0.2	-0.4	-0.2	0.5	0.0	0.0	0.3	
14	N	-104.6	-138.8	-137.4	-175.5	-132.4	-134.6	-82.4	-117.4	
	MX	1.5	-0.6	3.3	-1.1	5.9	-3.4	0.0	-2.8	
	QU	0.6	-0.2	1.3	-0.3	2.3	-1.5	0.0	-1.4	
	MU	-2.0	-3.2	0.0	0.0	-2.8	6.7	0.0	0.0	
	QX	0.8	-1.3	0.0	0.0	0.0	0.0	0.0	0.0	
1.220.1-3М.0-1.4 22МУЗ										
ГИП	Егунов				СТАДИЯ	ЛИСТ	ЛИСТОВ			
Н.КОНТР.	Бойко				Р	1	3			
РУК ГР.	Рудавин				ГОСГРАЖДАНСТРОЙ					
ПРОВЕРИЛ	Футорная				КиевЗНИИЭП					
РАЗРАБ	Зуенко				ЗДАНИЕ					
					3Т 4.5.30-ЗАЛ(12) 40-4.0					

ФОРМАТ А 4

Номер загрузки	Тип усилия	Номер группы элементов								
		1	2	3	4	5	6	7	8	
ЯРУС 2 СЕЧЕНИЕ 1										
1	N	0.0	0.0	0.0	0.0	3.1	1.7	0.0	0.0	
	MX	0.6	0.9	1.6	1.7	0.4	0.8	-0.6	-1.1	
	QU	-1.0	-0.8	-1.6	-1.3	-0.3	-0.8	0.2	1.0	
	MU	-0.6	-1.5	-0.9	1.9	-1.0	-0.3	1.3	1.0	
	QX	1.1	1.7	1.0	1.6	-1.1	0.0	-0.2	1.0	
8	N	0.0	0.0	0.0	0.0	-0.4	10.2	0.0	0.0	
	MX	0.1	0.1	0.0	0.0	0.0	0.0	0.0	0.0	
	QU	0.0	0.1	0.0	0.0	0.0	0.0	0.0	0.0	
	MU	-0.1	-0.2	-0.3	-0.4	-0.2	-0.3	-0.3	-0.2	
	QX	-0.1	-0.2	-0.1	-0.3	-0.1	-0.2	-0.1	-0.2	
9	N	0.0	0.0	0.0	0.0	7.4	2.7	0.0	0.0	
	MX	1.1	1.1	0.9	1.1	-0.6	0.3	0.6	1.2	
	QU	0.4	0.4	0.2	0.1	0.6	0.0	-0.2	0.5	
	MU	-0.5	-0.2	-0.4	-0.1	-0.1	0.2	0.0	0.4	
	QX	0.3	0.2	0.4	0.2	-0.1	0.0	0.0	-0.3	
14	N	74.3	102.2	101.5	134.0	55.2	67.0	44.1	84.7	
	MX	0.7	-0.2	1.4	-0.4	0.5	0.7	0.0	-0.5	
	QU	-0.6	0.1	-1.2	0.3	-0.2	-0.6	0.0	1.4	
	MU	0.9	1.3	0.0	0.0	-0.6	-0.6	0.0	0.0	
	QX	0.8	-1.3	-0.1	0.0	0.0	-0.6	0.0	0.0	
ЯРУС 2 СЕЧЕНИЕ 2										
1	N	0.0	0.0	0.0	0.0	-3.1	-1.7	0.0	0.0	
	MX	2.0	1.3	2.4	1.6	0.3	1.1	0.0	-1.2	
	QU	1.0	0.9	1.6	1.3	0.3	0.8	-0.2	-1.0	
	MU	2.1	2.5	1.6	1.9	-1.6	-0.2	0.0	1.4	
	QX	1.0	1.6	0.9	1.5	1.1	-0.1	0.2	-1.0	
8	N	0.0	0.0	0.0	0.0	0.4	-10.2	0.0	0.0	
	MX	-0.2	-0.2	-0.1	-0.1	0.0	-0.1	0.0	-0.1	
	QU	0.0	-0.1	0.0	0.0	0.0	0.0	0.0	0.0	
	MU	-0.1	-0.2	-0.2	-0.3	-0.2	-0.2	0.0	-0.2	
	QX	0.1	0.2	0.1	0.3	0.1	0.2	0.1	0.2	
9	N	0.0	0.0	0.0	0.0	-7.4	-2.7	0.0	0.0	
	MX	-2.1	-2.1	-1.4	-1.4	-0.7	-1.2	0.0	-2.3	
	QU	-0.4	-0.4	-0.2	-0.1	-0.6	-0.4	0.2	-0.5	
	MU	1.3	0.6	1.4	0.7	-0.8	0.3	0.0	-1.2	
	QX	0.3	-0.2	-0.4	0.0	0.1	0.0	0.0	0.3	
14	N	-74.3	-102.2	-101.5	-134.0	-55.2	-67.0	-44.1	-84.7	
	MX	0.8	-0.3	1.7	0.6	-1.0	-1.1	0.0	-3.0	
	QU	0.6	-0.2	1.3	0.2	-0.6	-0.7	0.0	-1.4	
	MU	-1.0	-1.8	-0.1	-0.1	-0.9	-1.1	0.0	0.0	
	QX	0.8	-1.3	0.0	0.0	0.6	-0.5	0.0	0.0	
1.220.1-3М.0-1.4 22МУЗ										
ИНВ № ПОДЛ	ПОДПИСЬ И ДАТА	ВЗАМ ИНВ №								ЛИСТ
										2

23171-04 51 ФОРМАТ А 4

Номер загрузки	Тип усилия	Номер группы элементов							
		1	2	3	4	5	6	7	8
ЯРУС 3 СЕЧЕНИЕ 1									
1	N	0.0	0.0	0.0	0.0	1.8	1.4	0.0	0.0
	MX	-2.0	-1.3	-2.4	-1.6	1.0	-2.9	0.0	1.2
	QU	0.7	0.5	0.9	0.6	-0.4	1.1	0.0	-0.2
	MU	-2.1	-2.5	-1.6	-1.9	-3.0	-0.6	0.0	-1.4
	QX	0.6	0.8	0.4	0.6	-1.1	-0.2	0.0	-0.5
8	N	0.0	0.0	0.0	0.0	-0.2	6.1	0.0	0.0
	MX	0.2	0.2	0.1	0.1	0.4	0.1	0.0	0.1
	QU	-0.1	-0.1	0.0	0.0	-0.2	0.0	0.0	0.0
	MU	0.1	0.2	0.2	0.3	-0.8	-0.5	0.0	0.2
	QX	0.0	0.1	0.0	0.1	0.1	-0.2	0.0	0.0
9	N	0.0	0.0	0.0	0.0	4.8	0.4	0.0	0.0
	MX	2.1	2.1	1.4	1.4	6.0	2.4	0.0	2.3
	QU	-0.2	-0.2	-0.1	-0.1	-1.8	-0.8	0.0	-0.8
	MU	-1.3	-0.6	-1.4	-0.7	0.8	-3.2	0.0	1.2
	QX	0.1	-0.1	-0.2	0.0	0.0	0.7	0.0	0.1
14	N	49.4	66.8	66.1	85.7	49.5	65.8	0.0	53.6
	MX	0.7	-0.4	1.4	-0.6	-2.0	1.8	0.0	1.0
	QU	-0.5	0.3	-0.9	0.4	1.2	-1.3	0.0	-1.2
	MU	1.0	1.6	0.1	0.1	-2.3	1.2	0.0	0.0
	QX	0.5	-0.8	0.1	0.0	-0.6	-0.4	0.0	0.0
ЯРУС 3 СЕЧЕНИЕ 2									
1	N	0.0	0.0	0.0	0.0	-1.3	-1.4	0.0	0.0
	MX	0.5	-0.2	-0.5	-0.3	0.5	-0.6	0.0	-0.6
	QU	0.6	-0.5	-0.9	-0.6	0.4	0.2	0.0	0.2
	MU	-0.5	-0.6	-0.4	-0.5	0.8	-0.2	0.0	-0.4
	QX	0.7	-0.8	-0.4	-0.6	1.1	-0.1	0.0	0.5
8	N	0.0	0.0	0.0	0.0	0.2	-6.1	0.0	0.0
	MX	0.1	0.0	0.0	0.0	0.1	0.0	0.0	0.0
	QU	0.0	0.0	0.0	0.0	0.2	0.0	0.0	0.0
	MU	-0.1	0.1	-0.1	0.1	-1.0	-0.2	0.0	-0.1
	QX	0.0	-0.1	0.0	-0.1	-0.1	0.2	0.0	0.0
9	N	0.0	0.0	0.0	0.0	-4.8	-0.4	0.0	0.0
	MX	-1.3	-1.3	-1.0	-1.0	-0.2	0.6	0.0	0.3
	QU	0.2	0.2	0.1	0.1	1.7	0.7	0.0	0.8
	MU	-0.8	-0.3	-0.7	0.3	-0.4	-0.4	0.0	-0.7
	QX	0.2	0.1	0.2	0.1	-0.1	-0.7	0.0	-0.1
14	N	-49.4	-66.8	-66.1	-85.7	-49.5	-65.8	0.0	-53.6
	MX	0.9	-0.5	1.6	-1.8	-2.0	2.5	0.0	3.0
	QU	0.5	-0.3	0.9	-0.7	-1.2	1.3	0.0	1.2
	MU	0.7	1.1	0.2	0.1	-2.3	0.5	0.0	-0.1
	QX	-0.5	0.8	-0.1	0.0	0.6	-0.4	0.0	0.0

1.220.1-3М.0-1.4 22МУ3

ЛИСТ
3

ФОРМАТ А4

Номер загрузки	Тип усилия	Номер группы элементов							
		1	2	3	4	5	6	7	8
ЯРУС 1 СЕЧЕНИЕ 1									
1	N	0.0	0.0	0.0	0.0	-13.9	-12.1	0.0	0.0
	MX	2.6	2.4	4.6	4.1	-11.1	6.3	-1.3	-3.1
	QU	-0.8	-0.6	-1.1	-0.9	6.3	-2.3	0.3	0.8
	MU	-2.6	-4.6	-2.7	-4.8	6.3	-8.4	2.7	2.7
	QX	-0.8	1.1	-0.7	-1.1	-1.9	-2.5	0.2	0.7
8	N	0.0	0.0	0.0	0.0	-0.6	-32.7	0.0	0.0
	MX	0.0	0.1	0.0	0.1	-0.1	0.0	0.0	0.0
	QU	0.0	0.0	0.0	0.0	0.1	0.0	0.0	0.0
	MU	-0.7	-1.1	-1.2	-2.0	-2.4	-9.0	-1.1	-1.1
	QX	-0.2	-0.3	-0.3	-0.4	-0.7	-5.2	-0.3	-0.3
9	N	0.0	0.0	0.0	0.0	-43.7	1.7	0.0	0.0
	MX	1.2	1.9	1.8	3.0	13.8	3.4	1.5	1.9
	QU	-0.4	-0.5	-0.5	-0.7	-7.9	-1.0	-0.4	-0.5
	MU	0.1	-0.1	-0.1	-0.1	0.0	0.3	0.0	0.2
	QX	0.1	0.0	-0.1	0.0	0.0	0.0	0.0	0.1
14	N	129.5	174.1	172.7	223.8	162.2	164.1	126.5	148.5
	MX	0.8	-0.3	1.8	-0.5	2.8	1.6	0.0	-0.9
	QU	-0.6	0.2	-1.4	0.4	-2.2	-1.1	0.0	0.8
	MU	1.1	-1.8	0.0	-0.1	-1.6	-3.2	0.0	0.0
	QX	0.8	-1.3	0.0	0.0	0.0	-0.8	0.0	0.0
ЯРУС 1 СЕЧЕНИЕ 2									
1	N	0.0	0.0	0.0	0.0	13.9	12.1	0.0	0.0
	MX	0.0	-0.3	-0.6	-0.9	-11.1	1.8	0.2	0.4
	QU	-0.5	0.6	1.1	0.9	-6.3	2.3	-0.3	-0.8
	MU	0.0	0.6	0.4	1.0	1.8	-8.5	-0.4	-0.4
	QX	-0.8	-1.1	-0.7	-1.1	1.9	2.5	0.2	-0.7
8	N	0.0	0.0	0.0	0.0	0.6	32.7	0.0	0.0
	MX	0.0	0.0	0.0	0.0	-0.1	0.0	0.0	0.0
	QU	0.0	0.0	0.0	0.0	-0.1	0.0	0.0	0.0
	MU	0.3	0.2	0.2	0.4	-0.3	-9.2	0.2	0.2
	QX	0.2	0.3	0.3	0.4	0.7	2.7	0.3	0.3
9	N	0.0	0.0	0.0	0.0	43.7	-1.7	0.0	0.0
	MX	0.2	-0.3	-0.3	-0.7	14.0	0.3	-0.3	-0.1
	QU	0.4	0.4	0.4	0.6	7.9	0.7	0.4	0.5
	MU	0.1	-0.1	-0.1	0.0	0.0	0.3	0.0	0.1
	QX	-0.1	0.0	0.0	0.0	0.0	0.1	0.0	-0.1
14	N	-129.5	-174.1	-172.7	-223.8	-162.2	-164.1	-126.5	-148.5
	MX	1.3	-0.5	3.0	-1.0	4.9	2.4	0.0	-1.9
	QU	0.5	-0.2	1.4	-0.4	2.2	1.1	0.0	-0.8
	MU	1.7	2.9	0.0	0.0	-2.3	-5.5	0.0	0.0
	QX	-0.8	1.3	0.0	0.0	0.0	0.8	0.0	0.0

1.220.1-3М.0-1.4 22МУ4

ПОДПИСЬ И ДАТА
ИЗМ. ИМБ №

ИМБ № ПОДП	ПОДПИСЬ И ДАТА	ИЗМ. ИМБ №
ГИП	Егузов	
И.КОНТР.	Бойко	
РУК.ГР.	Рудавин	
ПРОВЕРИЛ	Футорная	
РАЗРАБ	Зуенко	

ЗДАНИЕ
ИТ 4.5.30-ЗАЛ(12)32-3.5

СТАДИЯ	ЛИСТ	ЛИСТОВ
Р	1	4
ГОСГРАЖДАНСТРОЙ		
КиевЗНИИЭП		

23171-04 52

ФОРМАТ А4

Номер загрузки	Тип усилия	Номер группы элементов							
		1	2	3	4	5	6	7	8
ЯРУС 2 СЕЧЕНИЕ 1									
1	N	0.0	0.0	0.0	0.0	2.8	2.1	0.0	0.0
	MX	0.0	0.3	0.6	0.9	0.3	0.6	-0.2	-0.4
	QY	0.5	-0.6	-1.1	-0.9	-0.2	-1.1	0.3	0.8
	MU	0.0	-0.6	-0.4	-1.0	-0.7	0.2	0.4	0.4
	QX	0.8	1.1	0.7	1.1	-0.9	0.1	-0.2	0.7
8	N	0.0	0.0	0.0	0.0	-0.4	14.5	0.0	0.0
	MX	0.0	0.0	0.0	0.0	0.0	0.0	0.0	0.0
	QY	0.0	0.0	0.0	0.0	0.0	0.0	0.0	0.0
	MU	0.0	-0.2	-0.2	-0.4	-0.3	-0.4	-0.2	-0.2
	QX	-0.2	-0.3	-0.3	-0.4	-0.3	-0.3	-0.3	-0.3
9	N	0.0	0.0	0.0	0.0	17.4	2.0	0.0	0.0
	MX	-0.2	0.3	0.3	0.7	0.5	0.4	0.3	0.1
	QY	-0.4	-0.4	-0.4	-0.6	-0.4	-0.5	-0.4	-0.5
	MU	-0.1	0.1	0.1	0.0	0.0	0.0	0.0	-0.1
	QX	0.1	0.0	0.0	0.0	0.0	0.0	0.0	0.1
14	N	99.2	137.5	136.8	182.4	72.2	73.7	88.2	115.7
	MX	0.9	-0.3	1.7	-0.5	1.0	0.7	0.0	-1.3
	QY	-0.6	0.2	-1.3	0.4	-0.5	-0.4	0.0	0.8
	MU	-1.1	-1.6	0.0	0.0	-0.6	1.1	0.0	0.0
	QX	-0.8	1.3	0.0	0.0	0.0	-0.1	0.0	0.0
ЯРУС 2 СЕЧЕНИЕ 2									
1	N	0.0	0.0	0.0	0.0	-2.8	-2.1	0.0	0.0
	MX	1.8	1.1	2.1	1.3	0.2	2.1	-0.6	-1.5
	QY	0.8	0.6	1.1	0.9	0.2	1.1	-0.3	-0.8
	MU	-1.8	-2.2	-1.3	-1.6	2.1	0.2	1.2	1.3
	QX	0.8	1.1	0.7	1.1	0.9	-0.1	-0.2	-0.7
8	N	0.0	0.0	0.0	0.0	0.4	-14.5	0.0	0.0
	MX	0.1	0.1	0.0	0.0	0.0	0.0	0.0	0.0
	QY	0.0	0.0	0.0	0.0	0.0	0.0	0.0	0.0
	MU	-0.4	-0.5	-0.5	-0.6	-0.5	-0.3	-0.4	-0.5
	QX	0.2	0.3	0.3	0.4	0.3	0.0	0.3	0.3
9	N	0.0	0.0	0.0	0.0	-17.4	-2.0	0.0	0.0
	MX	1.1	1.2	1.0	1.2	0.4	0.8	0.6	1.2
	QY	0.4	0.5	0.5	0.7	0.4	0.5	0.4	0.5
	MU	0.3	-0.1	-0.3	-0.1	0.0	0.0	0.0	0.3
	QX	-0.1	0.0	0.1	0.0	0.0	0.0	0.0	-0.1
14	N	-99.2	-137.5	-136.8	-182.4	-72.2	-73.7	-88.2	-115.7
	MX	0.6	-0.4	1.5	-0.6	0.4	0.4	0.0	-0.6
	QY	0.6	-0.2	1.4	-0.4	0.1	0.4	0.0	-0.8
	MU	0.9	1.6	0.1	0.0	-0.5	0.4	0.0	0.0
	QX	-0.8	1.3	0.0	0.0	0.5	0.1	0.0	0.0

Номер загрузки	Тип усилия	Номер группы элементов							
		1	2	3	4	5	6	7	8
ЯРУС 3 СЕЧЕНИЕ 1									
1	N	0.0	0.0	0.0	0.0	1.2	1.1	0.0	0.0
	MX	-1.8	-1.1	-2.1	-1.3	0.1	-1.9	0.6	1.5
	QY	0.7	0.4	0.8	0.5	-0.1	0.8	-0.2	-0.5
	MU	1.8	2.2	1.3	1.6	-1.9	0.1	-1.2	-1.3
	QX	0.7	0.8	0.5	0.6	-0.8	0.0	-0.1	-0.5
6	N	0.0	0.0	0.0	0.0	-0.4	9.8	0.0	0.0
	MX	-0.1	-0.1	0.0	0.0	0.0	0.0	0.0	0.0
	QY	0.1	0.1	0.1	0.1	0.0	0.0	0.0	0.0
	MU	0.4	0.5	0.5	0.6	0.5	-0.2	0.4	0.5
	QX	0.2	0.2	0.3	0.3	0.2	-0.1	0.1	0.2
9	N	0.0	0.0	0.0	0.0	10.7	2.6	0.0	0.0
	MX	-1.1	-1.2	-1.0	-1.2	0.3	-1.1	-0.6	-1.2
	QY	1.1	1.1	0.9	1.0	-0.2	0.8	0.2	1.2
	MU	-0.3	0.1	0.3	0.1	-0.3	-0.1	0.0	-0.3
	QX	-0.5	0.2	0.5	0.0	0.0	0.0	0.0	-0.5
14	N	74.3	102.2	101.5	134.0	44.5	54.1	44.1	84.7
	MX	0.8	-0.3	1.5	-0.5	-0.7	0.7	0.0	-1.4
	QY	-0.5	0.2	-0.9	0.3	0.6	-0.4	0.0	1.3
	MU	-1.1	-1.7	-0.1	0.0	-0.7	-0.8	0.0	0.0
	QX	-0.6	1.1	0.0	0.0	-0.5	-0.6	0.0	0.0
ЯРУС 3 СЕЧЕНИЕ 2									
1	N	0.0	0.0	0.0	0.0	-1.3	-1.1	0.0	0.0
	MX	-0.4	-0.2	-0.5	-0.3	0.1	-0.8	0.0	0.3
	QY	-0.7	-0.4	-0.8	-0.5	0.1	-0.8	0.2	0.5
	MU	-0.4	-0.5	-0.3	-0.4	-0.8	0.1	0.0	-0.3
	QX	-0.7	-0.8	-0.5	-0.6	0.8	0.0	-0.1	0.5
8	N	0.0	0.0	0.0	0.0	0.4	-9.8	0.0	0.0
	MX	-0.2	-0.2	-0.1	-0.1	0.0	-0.1	0.0	-0.1
	QY	-0.1	-0.1	-0.1	-0.1	0.0	0.0	0.0	0.0
	MU	0.3	0.2	0.3	0.3	0.5	-0.1	0.0	0.2
	QX	-0.2	-0.2	-0.3	-0.3	-0.2	0.1	-0.1	-0.2
9	N	0.0	0.0	0.0	0.0	-10.7	-2.6	0.0	0.0
	MX	-2.7	-2.6	-1.9	-2.0	0.2	-1.6	0.0	-2.7
	QY	-1.1	-1.1	-0.9	-1.0	0.2	-0.8	-0.2	-1.2
	MU	1.3	0.6	1.3	0.6	-0.7	0.1	0.0	-1.3
	QX	0.5	-0.2	-0.5	0.0	0.0	0.0	0.0	0.5
14	N	-74.3	-102.2	-101.5	-134.0	-44.5	-54.1	-44.1	-84.7
	MX	0.8	-0.3	1.6	0.6	-1.2	-1.1	0.0	-3.1
	QY	0.5	-0.2	0.9	0.2	-0.6	-0.5	0.0	-1.3
	MU	-1.0	-1.8	-0.2	-0.1	-0.8	-1.3	0.0	0.0
	QX	0.6	-1.1	0.0	0.0	0.5	-0.5	0.0	0.0

Безупоко
 Оператор системы
 САПР КиевЗНИИЭП
 Инв № подл
 Подпись и дата
 Взам инв №

1.220.1-3М.0-1.4 22МУ4

ЛИСТ
2

1.220.1-3М.0-1.4 22МУ4

ЛИСТ
3

23171-04 53

Номер загрузки	Тип усилия	Номер группы элементов							
		1	2	3	4	5	6	7	8
ЯРУС 4 СЕЧЕНИЕ 1									
1	N	0.0	0.0	0.0	0.0	0.2	0.2	0.0	0.0
	MX	0.4	0.2	0.5	0.3	-0.1	-0.1	0.0	-0.3
	QY	-0.2	-0.1	-0.2	-0.1	0.0	0.0	0.0	0.0
	MV	0.4	0.5	0.3	0.4	-0.1	0.1	0.0	0.3
	QX	-0.1	-0.2	-0.1	-0.1	0.0	0.0	0.0	0.1
8	N	0.0	0.0	0.0	0.0	-0.2	5.7	0.0	0.0
	MX	0.2	0.2	0.1	0.1	0.3	0.1	0.3	0.1
	QY	0.0	0.0	0.0	0.0	-0.1	0.0	0.0	0.0
	MV	-0.3	-0.2	-0.2	-0.2	-1.0	-0.6	0.0	-0.2
	QX	-0.1	-0.1	-0.1	-0.1	-0.1	-0.2	0.0	-0.1
9	N	0.0	0.0	0.0	0.0	3.2	0.4	0.0	0.0
	MX	2.7	2.5	1.9	2.0	5.1	2.5	3.0	2.7
	QY	-0.4	-0.4	-0.3	-0.3	-1.1	-0.5	0.0	-0.8
	MV	-1.3	-0.6	-1.3	-0.6	3.3	-2.6	0.0	1.3
	QX	0.2	-0.1	-0.2	0.0	0.1	0.6	0.0	0.2
14	N	49.4	66.8	66.1	85.7	49.5	65.8	0.0	53.6
	MX	0.7	-0.5	1.5	-0.6	-2.2	1.9	0.0	1.1
	QY	-0.5	0.3	-0.9	0.4	1.3	-1.3	0.1	-1.2
	MV	1.0	1.6	0.2	0.7	-2.3	1.6	0.0	0.0
	QX	0.5	-0.8	0.1	0.0	-1.5	0.5	0.0	0.0
ЯРУС 4 СЕЧЕНИЕ 2									
1	N	0.0	0.0	0.0	0.0	-0.2	-0.2	0.0	0.0
	MX	-0.1	0.0	0.1	0.1	0.0	0.0	0.0	0.1
	QY	-0.1	0.1	0.2	0.1	0.0	0.0	0.0	0.0
	MV	0.1	0.1	0.1	0.1	0.1	0.0	0.0	0.0
	QX	-0.1	0.2	0.5	0.1	0.0	0.0	0.0	-0.1
8	N	0.0	0.0	0.0	0.0	0.2	-5.7	0.0	0.0
	MX	0.0	0.0	0.0	0.0	0.0	0.0	0.0	0.0
	QY	0.0	0.0	0.0	0.0	0.0	0.0	0.0	0.0
	MV	-0.1	-0.1	-0.1	0.0	-0.9	-0.2	0.0	-0.1
	QX	0.1	0.1	0.1	0.1	0.0	0.1	0.0	0.1
9	N	0.0	0.0	0.0	0.0	-5.2	-3.4	0.0	0.0
	MX	-1.3	-1.2	-1.3	-0.9	-0.5	-0.5	0.0	0.1
	QY	0.4	0.4	0.3	0.3	1.4	0.4	0.0	0.8
	MV	0.7	0.3	0.7	0.3	-3.4	-0.4	0.0	-0.7
	QX	0.2	0.1	0.2	0.1	0.0	0.7	0.0	-0.2
14	N	-49.4	-66.8	-66.1	-85.7	-49.5	-65.8	0.0	-53.6
	MX	0.9	-0.5	1.6	-1.8	-2.1	2.5	0.0	2.9
	QY	0.5	-0.3	0.9	-0.7	-1.3	1.3	0.0	1.2
	MV	0.7	1.1	0.2	0.7	-2.3	-0.6	0.0	-0.1
	QX	-0.5	0.8	-0.1	0.0	0.6	0.5	0.0	0.0

Номер загрузки	Тип усилия	Номер группы элементов							
		1	2	3	4	5	6	7	8
ЯРУС 1 СЕЧЕНИЕ 1									
1	N	0.0	0.0	0.0	0.0	-10.7	-5.5	0.0	0.0
	MX	7.5	6.5	12.1	9.5	-39.3	16.3	-2.9	-7.6
	QY	-2.2	-1.7	-3.2	-2.4	30.3	-5.3	0.8	2.1
	MV	7.3	-11.7	-6.9	-10.2	15.7	33.8	6.8	7.0
	QX	-2.1	3.1	-1.9	-2.6	-4.5	-13.2	0.5	1.9
3	N	0.0	0.0	0.0	0.0	-0.6	-30.1	0.0	0.0
	MX	0.0	0.1	0.0	0.1	-0.1	0.0	0.0	0.0
	QY	0.0	0.0	0.0	0.0	0.1	0.0	0.0	0.0
	MV	-0.4	-0.5	-0.6	-0.9	-1.1	-6.4	-0.5	-0.5
	QX	-0.1	-0.1	-0.2	-0.2	-0.3	-5.5	-0.1	-0.1
9	N	0.0	0.0	0.0	0.0	-40.9	1.4	0.0	0.0
	MX	-0.9	1.3	1.1	1.5	11.2	1.5	0.6	1.0
	QY	-0.3	-0.4	-0.3	-0.3	-9.4	-0.4	-0.2	-0.4
	MV	0.2	-0.1	-0.3	-0.2	-0.1	0.5	-0.1	0.3
	QX	0.1	-0.1	-0.1	0.0	0.0	0.0	0.0	0.1
14	N	129.5	174.1	172.7	223.8	148.3	143.3	125.5	148.5
	MX	0.5	-0.2	0.5	-0.2	5.4	1.1	0.0	0.2
	QY	-0.7	0.3	-1.4	0.1	-7.0	-1.4	0.0	0.3
	MV	0.7	0.8	0.1	0.0	-1.2	7.4	0.0	0.0
	QX	1.0	-1.5	0.0	0.0	0.0	-4.2	0.0	0.0
ЯРУС 1 СЕЧЕНИЕ 2									
1	N	0.0	0.0	0.0	0.0	10.7	5.5	0.0	0.0
	MX	-2.1	-2.1	-4.0	-3.4	-36.5	-2.5	1.0	2.0
	QY	2.2	1.7	3.2	2.4	-30.3	5.3	-0.8	-2.1
	MV	-2.0	3.8	2.3	3.6	4.1	-31.7	-2.3	-2.3
	QX	-2.1	-3.1	1.9	2.6	4.5	-10.1	-0.6	-1.9
8	N	0.0	0.0	0.0	0.0	0.6	30.1	0.0	0.0
	MX	0.0	0.0	0.0	0.0	-0.1	0.0	0.0	0.0
	QY	0.0	0.0	0.0	0.0	-0.1	0.0	0.0	0.0
	MV	0.1	0.2	0.2	0.3	0.4	-7.5	0.2	0.2
	QX	0.1	0.1	0.1	0.2	0.3	5.5	0.1	0.1
9	N	0.0	0.0	0.0	0.0	40.9	-1.4	0.0	0.0
	MX	-0.2	-0.3	-0.3	-0.4	12.2	-0.6	-0.3	-0.3
	QY	-0.1	0.2	0.2	0.3	9.4	0.3	0.2	0.4
	MV	-0.1	0.0	0.0	0.0	0.1	0.4	0.0	0.0
	QX	-0.1	0.0	-0.1	0.1	0.0	0.0	0.0	-0.1
14	N	-129.5	-174.1	-172.7	-223.8	-148.3	-143.3	-125.5	-148.5
	MX	1.3	-0.5	3.0	-1.0	11.2	2.5	0.0	-2.1
	QY	0.7	-0.2	1.4	-0.4	7.0	1.4	0.0	-0.8
	MV	1.7	2.9	0.0	0.0	-2.3	12.7	0.0	0.0
	QX	-1.0	-1.5	0.0	0.0	0.0	4.2	0.0	0.0

Безупоко
ОПЕРАТОР СИСТЕМА
САПР КиевЗНИИЭП

ИНВ № ПОДЛ ПОДПИСЬ И ДАТА
ВЗНМ ИНВ №

1.220.1-3М.0-1.4 22МУ5

ГИП	Егумов							СТАДИЯ	ЛИСТ	ЛИСТОВ
Н.КОНТР.	Бойко							Р	1	4
РУК.ГР	Рудавин							ГОСГРАЖДАНСТРОЙ КиевЗНИИЭП		
ПРОВЕРИЛ	Футорная									
РАЗРАБ	Зуенко									

ВДАНИЕ
АТ 4.5.30-ЗАЛ(12)40-2.5

23174-04 54

Номер загрузки	Тип усилия	Номер группы элементов							
		1	2	3	4	5	6	7	8
ЯРУС 2 СЕЧЕНИЕ 1									
1	N	0.0	0.0	0.0	0.0	-10.4	-9.1	0.0	0.0
	MX	2.1	2.1	4.0	3.4	0.5	2.4	-1.0	-2.5
	QY	-2.2	-1.7	-3.2	-2.4	-0.3	-2.5	0.8	2.1
	MY	2.0	-3.8	-2.3	-3.6	2.3	0.4	2.3	2.3
	QX	2.1	3.1	-1.9	-2.6	-2.0	0.2	0.6	1.9
8	N	0.0	0.0	0.0	0.0	-0.4	14.4	0.0	0.0
	MX	0.0	0.0	0.0	0.0	0.0	0.0	0.0	0.0
	QY	0.0	0.0	0.0	0.0	0.0	0.0	0.0	0.0
	MY	-0.1	-0.2	-0.2	-0.3	-0.1	-0.5	-0.2	-0.2
	QX	-0.1	-0.1	-0.1	-0.2	-0.1	-0.1	-0.1	-0.1
9	N	0.0	0.0	0.0	0.0	17.0	1.9	0.0	0.0
	MX	0.2	0.3	0.3	0.4	0.5	0.3	0.3	0.3
	QY	-0.1	-0.2	-0.2	-0.3	-0.4	-0.2	-0.2	-0.4
	MY	0.1	0.0	0.0	0.0	0.0	0.0	0.0	0.0
	QX	0.1	0.0	0.1	-0.1	0.0	0.0	0.0	0.1
14	N	99.2	137.5	136.8	182.4	62.4	66.6	88.2	115.7
	MX	0.9	-0.3	1.7	-0.5	0.7	0.7	0.0	-1.2
	QY	-0.7	0.3	-1.4	0.5	-0.3	-0.5	0.0	0.8
	MY	-1.2	-1.6	0.0	0.0	-0.6	0.7	0.0	0.0
	QX	-0.9	-1.5	0.0	0.0	-0.1	0.0	0.0	0.0
ЯРУС 2 СЕЧЕНИЕ 2									
1	N	0.0	0.0	0.0	0.0	10.4	9.1	0.0	0.0
	MX	3.1	2.0	3.8	2.5	0.3	3.6	-0.9	-2.4
	QY	2.2	1.7	3.2	2.4	0.3	2.5	-0.8	-2.1
	MY	3.0	-3.7	-2.2	-2.7	3.6	0.2	2.0	2.2
	QX	2.1	-3.1	1.9	2.6	2.0	-0.2	-0.6	-1.9
8	N	0.0	0.0	0.0	0.0	0.4	-14.4	0.0	0.0
	MX	0.1	0.1	0.0	0.0	0.0	0.0	0.0	0.0
	QY	0.0	0.0	0.0	0.0	0.0	0.0	0.0	0.0
	MY	-0.1	-0.1	-0.2	-0.2	-0.1	-0.3	-0.1	-0.1
	QX	0.1	0.1	0.2	0.2	0.1	0.1	0.1	0.1
9	N	0.0	0.0	0.0	0.0	-17.0	-1.9	0.0	0.0
	MX	0.7	0.7	0.6	0.6	0.4	0.3	0.1	0.8
	QY	0.3	0.4	0.3	0.5	0.4	0.2	0.2	0.4
	MY	0.3	-0.2	-0.3	-0.2	0.1	0.0	0.0	0.3
	QX	-0.1	0.1	0.1	0.0	0.0	0.0	0.0	-0.1
14	N	-99.2	-137.5	-136.8	-182.4	-62.4	-66.6	-88.2	-115.7
	MX	0.8	-0.4	1.7	-0.6	0.3	0.6	0.0	-0.6
	QY	0.7	-0.3	1.4	-0.5	0.0	0.5	0.0	-0.8
	MY	1.1	1.9	0.1	0.0	-0.7	-0.2	0.0	0.0
	QX	-1.0	1.5	0.0	0.0	0.5	0.1	0.0	0.0

1.220.1-3М.0-1.4 22МУ5

ЛИСТ
2

Номер загрузки	Тип усилия	Номер группы элементов							
		1	2	3	4	5	6	7	8
ЯРУС 3 СЕЧЕНИЕ 1									
1	N	0.0	0.0	0.0	0.0	-3.4	-2.8	0.0	0.0
	MX	-3.1	-2.0	-3.8	-2.5	0.2	-2.8	0.9	2.4
	QY	1.1	0.7	1.4	0.9	-0.1	1.2	-0.3	-0.9
	MY	-3.0	3.7	2.2	2.7	-2.8	0.1	-2.0	-2.2
	QX	1.1	-1.4	0.8	1.0	0.8	0.1	-0.2	-0.8
8	N	0.0	0.0	0.0	0.0	-0.5	9.7	0.0	0.0
	MX	-0.1	-0.1	0.0	0.0	0.0	0.0	0.0	0.0
	QY	0.1	0.1	0.1	0.1	0.0	0.0	0.0	0.0
	MY	0.1	-0.1	0.2	0.2	0.2	-0.2	0.1	0.1
	QX	0.1	0.1	0.1	0.1	0.1	-0.1	0.0	0.1
9	N	0.0	0.0	0.0	0.0	10.3	2.6	0.0	0.0
	MX	-0.7	-0.7	-0.6	-0.6	0.3	-0.6	-0.1	-0.8
	QY	1.0	1.0	0.7	0.8	-0.1	0.6	0.0	1.0
	MY	-0.3	0.2	0.3	0.2	-0.3	0.1	0.0	-0.3
	QX	-0.5	0.2	0.5	0.0	0.0	0.0	0.0	-0.5
14	N	74.3	102.2	101.5	134.0	44.7	54.2	44.1	84.7
	MX	0.6	-0.2	1.3	-0.4	-0.7	-0.6	0.0	-1.3
	QY	-0.4	0.2	-0.8	0.3	0.6	0.5	0.0	1.3
	MY	-0.9	-1.5	-0.1	0.0	-0.5	-0.7	0.0	0.0
	QX	-0.5	1.0	0.0	0.0	-0.4	0.5	0.0	0.0
ЯРУС 3 СЕЧЕНИЕ 2									
1	N	0.0	0.0	0.0	0.0	3.4	2.8	0.0	0.0
	MX	-0.7	-0.4	-0.9	-0.6	0.1	-1.2	0.0	0.4
	QY	-1.1	-0.7	-1.4	-0.9	0.1	-1.2	0.3	0.9
	MY	-0.7	0.9	-0.5	-0.6	-1.2	0.1	0.0	-0.5
	QX	-1.1	-1.4	-0.8	-1.0	1.2	-0.1	-0.2	0.8
8	N	0.0	0.0	0.0	0.0	0.5	-9.7	0.0	0.0
	MX	-0.2	-0.2	-0.1	-0.1	0.0	-0.1	0.0	-0.1
	QY	-0.1	-0.1	-0.1	-0.1	0.0	0.0	0.0	0.0
	MY	0.2	0.2	0.2	0.2	0.4	-0.1	0.0	0.1
	QX	-0.1	-0.1	-0.1	-0.1	0.0	0.1	0.0	-0.1
9	N	0.0	0.0	0.0	0.0	-10.3	-2.6	0.0	0.0
	MX	-2.6	-2.5	-1.9	-1.9	0.2	-1.5	0.0	-2.6
	QY	-1.0	-1.0	-0.7	-0.8	0.1	-0.6	0.0	-1.0
	MY	1.3	0.6	1.4	0.6	-0.7	0.1	0.0	-1.2
	QX	0.5	-0.2	-0.5	0.0	0.3	0.0	0.0	0.5
14	N	-74.3	-102.2	-101.5	-134.0	-44.7	-54.2	-44.1	-84.7
	MX	0.8	-0.3	1.5	0.6	-1.2	-1.0	0.0	-3.0
	QY	0.4	-0.2	0.8	0.2	-0.6	-0.5	0.0	-1.3
	MY	-1.0	-1.8	-0.2	-0.1	-0.7	-1.3	0.0	0.0
	QX	0.5	-1.0	0.0	0.0	0.4	-0.5	0.0	0.0

1.220.1-3М.0-1.4 22МУ5

ЛИСТ
3

КиевНИИЭП

САПР ОПЕРАТОР СИСТЕМЫ Безудова В.Б.

ИНВ № ПОДЛ ПОДПИСЬ И ДАТА ВЗАМ ИНВ №

Номер загрузки	Тип усилки	Номер группы элементов							
		1	2	3	4	5	6	7	8
ЯРУС 4 СЕЧЕНИЕ 1									
1	N	0.0	0.0	0.0	0.0	-0.6	-0.6	0.0	0.0
	MX	0.7	0.4	0.9	0.6	-0.2	-0.2	0.0	-0.4
	QY	-0.3	-0.2	-0.3	-0.2	0.1	0.1	0.0	0.1
	MY	0.7	-0.9	0.5	0.6	0.0	0.1	0.0	0.5
	QX	-0.2	-0.3	-0.2	-0.2	0.0	0.0	0.0	0.2
8	N	0.0	0.0	0.0	0.0	-0.2	5.8	0.0	0.0
	MX	0.2	0.2	0.1	0.1	0.3	0.1	0.0	0.1
	QY	0.0	0.0	0.0	0.0	-0.1	0.0	0.0	0.0
	MY	-0.2	-0.2	-0.2	-0.2	-1.0	-0.6	0.0	-0.1
	QX	-0.1	0.0	-0.1	-0.1	-0.1	-0.2	0.0	-0.1
9	N	0.0	0.0	0.0	0.0	5.2	0.4	0.0	0.0
	MX	2.6	2.5	1.9	1.9	5.2	2.5	0.0	2.6
	QY	-0.4	-0.4	-0.3	-0.3	-1.4	-0.8	0.0	-0.8
	MY	-1.3	-0.6	-1.4	-0.6	0.8	-2.6	0.0	1.2
	QX	0.2	-0.1	-0.2	0.0	0.1	0.6	0.0	0.2
14	N	49.4	66.8	66.1	85.7	49.5	65.8	0.0	53.6
	MX	0.8	-0.5	1.6	-0.7	-2.2	1.9	0.0	1.1
	QY	-0.5	0.3	-1.0	0.4	1.3	-1.3	0.0	-1.2
	MY	1.0	1.6	0.2	0.1	-2.3	1.6	0.0	0.0
	QX	0.5	-0.8	0.1	0.0	-0.6	0.5	0.0	0.0
ЯРУС 4 СЕЧЕНИЕ 2									
1	N	0.0	0.0	0.0	0.0	0.6	0.6	0.0	0.0
	MX	-0.1	0.1	0.2	0.1	-0.1	-0.1	0.0	-0.2
	QY	-0.2	0.2	0.3	0.2	-0.1	-0.1	0.0	-0.1
	MY	0.1	0.2	0.1	0.1	0.0	0.1	0.0	-0.1
	QX	-0.2	0.3	0.2	0.2	0.0	0.0	0.0	-0.2
8	N	0.0	0.0	0.0	0.0	0.2	-5.8	0.0	0.0
	MX	0.0	0.0	0.0	0.0	0.0	0.0	0.0	0.0
	QY	0.0	0.0	0.0	0.0	0.1	0.0	0.0	0.0
	MY	-0.1	0.0	-0.1	0.0	-0.9	-0.2	0.0	-0.1
	QX	0.1	0.0	0.1	0.0	0.1	0.2	0.0	0.1
9	N	0.0	0.0	0.0	0.0	-5.2	-0.4	0.0	0.0
	MX	-1.3	-1.3	-1.0	-0.9	-0.5	0.5	0.0	0.1
	QY	0.4	0.4	0.3	0.3	1.4	0.7	0.0	0.8
	MY	0.7	0.3	0.7	0.3	-0.4	-0.4	0.0	-0.7
	QX	0.2	0.1	0.2	0.1	0.0	-0.5	0.0	-0.2
14	N	-49.4	-66.8	-66.1	-85.7	-49.5	-65.8	0.0	-53.6
	MX	0.9	-0.5	1.6	-1.8	-2.1	2.5	0.0	2.9
	QY	0.5	-0.3	1.0	-0.7	-1.3	1.3	0.0	1.2
	MY	0.7	1.1	0.2	0.1	-2.3	-0.6	0.0	-0.1
	QX	-0.5	0.8	-0.1	0.0	0.6	0.5	0.0	0.0

1.220.1-3М.0-1.4 22МУ6

ЛИСТ
4

Номер загрузки	Тип усилки	Номер группы элементов							
		1	2	3	4	5	6	7	8
ЯРУС 1 СЕЧЕНИЕ 1									
1	N	0.0	0.0	0.0	0.0	-19.1	-16.1	0.0	0.0
	MX	4.7	4.2	8.1	7.0	-20.6	10.3	-2.2	-5.5
	QY	-1.0	-0.9	-1.6	-1.3	10.2	-2.8	0.5	1.1
	MY	4.6	-8.1	-4.8	-8.1	-10.4	15.9	4.7	4.8
	QX	1.0	1.6	1.0	1.5	-2.4	4.0	0.3	1.0
8	N	0.0	0.0	0.0	0.0	0.6	-33.2	0.0	0.0
	MX	0.0	0.1	0.0	0.1	-0.1	0.0	0.0	0.0
	QY	0.0	0.0	0.0	0.0	0.1	0.0	0.0	0.0
	MY	-0.7	-1.3	-1.3	-2.1	-2.6	-10.4	-1.2	-1.2
	QX	-0.2	-0.3	-0.3	-0.4	-0.6	-5.3	-0.2	-0.2
9	N	0.0	0.0	0.0	0.0	-44.8	1.3	0.0	0.0
	MX	1.4	2.2	2.1	3.4	17.0	3.8	1.8	2.3
	QY	-0.4	-0.5	-0.4	-0.7	-8.5	-0.8	-0.3	-0.5
	MY	0.2	-0.1	-0.2	-0.1	-0.1	0.6	-0.1	0.2
	QX	0.1	0.0	-0.1	0.0	0.0	0.0	0.0	0.1
14	N	129.5	174.1	172.7	223.8	167.1	169.2	126.5	148.5
	MX	0.9	-0.4	1.7	-0.6	4.9	1.7	0.0	-0.7
	QY	-0.6	0.2	-1.2	0.4	-3.5	-1.1	0.0	0.7
	MY	1.2	1.8	0.1	-0.1	-1.7	5.6	0.0	0.0
	QX	0.8	-1.3	0.0	0.0	0.0	-1.4	0.0	0.0
ЯРУС 1 СЕЧЕНИЕ 2									
1	N	0.0	0.0	0.0	0.0	19.1	16.1	0.0	0.0
	MX	-0.3	-0.8	-1.3	-1.6	-20.3	0.9	0.4	1.0
	QY	1.0	0.9	1.6	1.3	-10.2	2.8	-0.5	-1.1
	MY	-0.5	1.5	0.9	1.9	0.9	16.1	-0.9	-0.9
	QX	-1.0	-1.6	-1.0	-1.5	2.4	4.1	0.3	-1.0
8	N	0.0	0.0	0.0	0.0	-0.6	33.2	0.0	0.0
	MX	0.0	0.0	0.0	0.0	-0.1	0.0	0.0	0.0
	QY	0.0	0.0	0.0	0.0	-0.1	0.0	0.0	0.0
	MY	0.1	0.3	0.2	0.5	0.3	-10.7	0.3	0.2
	QX	0.2	0.3	0.3	0.4	0.6	2.7	0.2	0.2
9	N	0.0	0.0	0.0	0.0	44.8	-1.3	0.0	0.0
	MX	-0.2	-0.5	-0.4	-0.8	16.9	-0.5	-0.4	-0.2
	QY	0.2	0.4	0.4	0.6	8.5	0.8	0.3	0.5
	MY	0.1	-0.1	-0.1	0.0	0.0	0.5	0.0	0.1
	QX	0.0	0.0	0.0	0.0	0.0	0.0	0.0	-0.1
14	N	-129.5	-174.1	-172.7	-223.8	-167.1	-169.2	-126.5	-148.5
	MX	1.4	-0.6	3.3	-1.0	9.0	2.8	0.0	-2.1
	QY	0.6	-0.2	1.2	-0.4	3.5	1.1	0.0	-0.7
	MY	1.9	3.2	0.0	0.0	-2.7	10.1	0.0	0.0
	QX	-0.8	1.3	0.0	0.0	0.0	1.4	0.0	0.0

1.220.1-3М.0-1.4 22МУ6

ИНВ. № ПОДП
ПОДПИСЬ И ДАТА
ВЗАМ. ИНВ. №

ГИП Егунов
И КОНТР. Бойко
РУК. ГР. Рудакин
ПРОВЕРИЛ Футорная
РАЗРАБ Зуенко

ЭДАНИЕ
4Т 4.5.30-ЗАЛ(12)40-4.0

СТАДИЯ ЛИСТ ЛИСТОВ
Р 1 4
ГОСГРАЖДАНСТРОЙ
КиевЗНИИЭП

Номер загрузки	Тип усилия	Номер группы элементов							
		1	2	3	4	5	6	7	8
ЯРУС 2 СЕЧЕНИЕ 1									
1	N	0.0	0.0	0.0	0.0	3.6	2.7	0.0	0.0
	MX	0.5	0.8	1.5	1.6	0.4	0.9	-0.4	-1.0
	QY	-1.0	-0.9	-1.6	-1.3	-0.3	-1.3	0.5	1.1
	MU	0.3	-1.5	-0.9	-1.9	-1.0	0.2	0.9	0.9
	QX	1.0	1.6	1.0	1.5	-1.1	-0.1	-0.3	1.0
8	N	0.0	0.0	0.0	0.0	-0.4	13.5	0.0	0.0
	MX	0.0	0.0	0.0	0.0	0.0	0.0	0.0	0.0
	QY	0.0	0.0	0.0	0.0	0.0	0.0	0.0	0.0
	MU	-0.1	-0.3	-0.2	-0.5	-0.3	-0.4	-0.3	-0.2
	QX	-0.2	-0.3	-0.3	-0.4	-0.2	-0.3	-0.2	-0.2
9	N	0.0	0.0	0.0	0.0	15.6	2.0	0.0	0.0
	MX	0.2	0.5	0.4	0.8	0.3	0.4	0.4	0.2
	QY	-0.2	-0.4	-0.4	-0.6	-0.2	-0.4	-0.3	-0.5
	MU	-0.1	0.1	0.1	0.0	0.0	-0.1	0.0	-0.1
	QX	0.0	0.0	0.0	0.0	0.0	0.0	0.0	0.1
14	N	99.2	137.5	126.8	182.4	70.0	71.1	88.2	115.7
	MX	0.7	-0.2	1.4	-0.4	1.0	0.6	0.0	-1.1
	QY	-0.6	0.2	-1.2	0.4	-0.5	-0.4	0.0	0.7
	MU	-0.9	-1.3	0.0	0.0	-0.5	1.1	0.0	0.0
	QX	-0.8	1.3	0.0	0.0	-0.1	-0.1	0.0	0.0
ЯРУС 2 СЕЧЕНИЕ 2									
1	N	0.0	0.0	0.0	0.0	-3.6	-2.7	0.0	0.0
	MX	1.9	1.2	2.4	1.6	0.3	2.2	-0.7	-1.3
	QY	1.0	0.9	1.6	1.3	0.3	1.3	-0.5	-1.1
	MU	2.0	-2.4	-1.6	-1.8	2.3	0.2	1.3	1.4
	QX	-1.0	-1.6	1.0	1.6	1.1	-0.1	-0.3	-1.0
8	N	0.0	0.0	0.0	0.0	0.4	-13.5	0.0	0.0
	MX	0.1	0.1	0.0	0.0	0.0	0.0	0.0	0.0
	QY	0.0	0.0	0.0	0.0	0.0	0.0	0.0	0.0
	MU	-0.2	-0.3	-0.4	-0.4	-0.4	-0.2	-0.3	-0.3
	QX	0.2	0.3	0.3	0.4	0.3	0.0	0.2	0.2
9	N	0.0	0.0	0.0	0.0	-15.6	-2.0	0.0	0.0
	MX	0.9	1.0	0.8	1.3	0.2	0.6	0.4	1.0
	QY	0.4	0.5	0.4	0.7	0.2	0.4	0.3	0.5
	MU	0.3	-0.1	-0.3	-0.1	0.0	0.0	0.0	0.3
	QX	-0.1	0.0	0.1	0.0	0.0	0.0	0.0	-0.1
14	N	-99.2	-137.5	-126.8	-182.4	-70.0	-71.1	-88.2	-115.7
	MX	0.7	-0.4	1.6	-0.6	0.3	0.4	0.0	-0.6
	QY	-0.6	-0.2	1.2	-0.4	0.1	0.4	0.0	-0.7
	MU	0.9	1.7	0.1	0.0	-0.5	0.4	0.0	0.0
	QX	-0.8	1.3	0.0	0.0	0.4	0.1	0.0	0.0

ЛИСТ
2

1.220.1-3М.0-1.4 22МУ6

Номер загрузки	Тип усилия	Номер группы элементов							
		1	2	3	4	5	6	7	8
ЯРУС 3 СЕЧЕНИЕ 1									
1	N	0.0	0.0	0.0	0.0	1.7	1.4	0.0	0.0
	MX	-1.9	-1.2	-2.4	-1.6	0.1	-2.0	0.7	1.6
	QY	0.7	0.4	0.9	0.6	-0.1	0.8	-0.2	-0.6
	MU	-2.0	2.4	1.4	1.8	-2.0	0.1	-1.3	-1.4
	QX	-0.7	-0.9	0.5	0.7	-0.8	0.0	-0.1	-0.5
8	N	0.0	0.0	0.0	0.0	-0.5	9.6	0.0	0.0
	MX	-0.1	-0.1	0.0	0.0	0.0	0.0	0.0	0.0
	QY	0.1	0.1	0.1	0.1	0.0	0.0	0.0	0.0
	MU	0.3	0.3	0.4	0.4	0.4	-0.2	0.3	0.3
	QX	0.2	0.2	0.2	0.2	0.1	-0.1	0.1	0.1
9	N	0.0	0.0	0.0	0.0	13.1	2.7	0.0	0.0
	MX	-0.9	-1.0	-0.8	-1.0	0.2	-0.9	-0.4	-1.0
	QY	1.1	1.1	0.8	0.9	-0.1	0.7	0.1	1.1
	MU	-1.3	0.1	0.3	0.1	-0.2	0.1	0.0	-0.3
	QX	-0.3	0.2	0.5	0.0	0.0	0.0	0.0	-0.5
14	N	74.3	102.2	101.5	134.0	44.5	53.9	44.1	84.7
	MX	0.7	-0.3	1.4	-0.5	-0.7	-0.6	0.0	-1.3
	QY	-0.5	0.2	-0.9	0.3	0.6	0.5	0.0	1.3
	MU	-1.0	-1.7	-0.1	0.0	-0.6	-0.6	0.0	0.0
	QX	-0.6	1.1	0.0	0.0	-0.4	0.5	0.0	0.0
ЯРУС 3 СЕЧЕНИЕ 2									
1	N	0.0	0.0	0.0	0.0	-1.7	-1.4	0.0	0.0
	MX	-0.4	-0.3	-0.6	-0.4	0.1	-0.8	0.0	0.3
	QY	-0.7	-0.5	-0.9	-0.6	0.1	-0.6	0.2	0.6
	MU	-0.5	-0.6	-0.3	-0.4	-0.8	0.1	0.0	-0.3
	QX	-0.7	-0.9	-0.5	-0.7	0.8	0.0	-0.1	0.5
8	N	0.0	0.0	0.0	0.0	0.5	-9.6	0.0	0.0
	MX	-0.2	-0.2	-0.1	-0.1	0.0	-0.1	0.0	-0.1
	QY	-0.1	-0.1	-0.1	-0.1	0.0	0.0	0.0	0.0
	MU	0.3	0.2	0.3	0.2	0.4	-0.1	0.0	0.2
	QX	-0.2	-0.2	-0.2	-0.2	-0.1	0.1	-0.1	-0.1
9	N	0.0	0.0	0.0	0.0	-10.1	-2.7	0.0	0.0
	MX	-2.6	-2.6	1.9	-2.0	0.2	-1.6	0.0	-2.7
	QY	1.1	-1.1	-0.8	-0.9	0.1	-0.7	-0.1	-1.1
	MU	1.3	0.6	1.3	0.6	-0.7	0.1	0.0	-1.2
	QX	0.5	-0.2	-0.5	0.0	0.0	0.0	0.0	0.5
14	N	-74.3	-102.2	-101.5	-134.0	-44.5	-53.9	-44.1	-84.7
	MX	0.8	-0.3	1.6	-0.6	-1.2	-1.1	0.0	-3.1
	QY	0.5	-0.2	0.9	0.2	-0.6	-0.5	0.0	-1.3
	MU	-1.0	-1.8	-0.2	-0.1	-0.8	-1.3	0.0	0.0
	QX	0.6	-1.1	0.0	0.0	0.4	-0.5	0.0	0.0

ЛИСТ
3

1.220.1-3М.0-1.4 22МУ6

ИНВ № ПОДЛ
ПОДПИСЬ И ДАТА
ВЗЛМ ИНВ. №

САПР
Курс/Мин/ЭП

ОПЕРАТОР
СИСТЕМ

Результат
Days

МАРКА ПОЗ	ОБОЗНАЧЕНИЕ	НАИМЕНОВАНИЕ	КОП.	МАССА ЕД. КГ	ПРИМЕЧАНИЕ
		ДОКУМЕНТАЦИЯ			
A3	I.220.I-3M.0-I.4 00TO	ТЕХНИЧЕСКОЕ ОПИСАНИЕ СБОРОЧНЫЕ ЕДИНИЦЫ РИГЕЛЬ			
P1	I.220.I-3M.3-I 03-02	РДП4.53-50	6	2518	
P2	I.220.I-3M.3-I 01-01	РДП4.53-90АТУ	13	2518	
P5	I.220.I-3M.3-I 05	РДП4.65-50	2	3090	
P6	I.220.I-3M.3-I 01	РДП4.65-90АТУ	5	3090	
P9	I.220.I-3M.3-I 09	Р4.57-20	14	1710	
PI0	I.020-I/83.3-I 07-01	РОП 4.57-30	9	2070	
PI4	I.020-I/83.3-I 02-02	РДП 4.57-60АТУ	4	2600	
PII	I.020-I/83.3-I 10	РОП 4.69-30АТУ	2	2520	
PI2	I.020-I/83.3-I 04-02	РДП 4.69-60АТУ	5	3170	
		СВЯЗЕВАЯ ПЛИТА			
PI3	I.04I.I-2.I.400-01 ПЕРЕМЕННЫЕ ДАННЫЕ	ПК56.I5-6АТИУС(АЛУ)Т-2 ДЛЯ ИСПОЛНЕНИЯ I.220.I-3M.0-I.4 23 3Т.4.6 30-ЗАЛ(12) 40-2.5	10	2600	
		РОСТВЕРК			
Ф1	I.220.I-3M.I-I 04-01	Ф3-40	4	3625	
Ф2	I.220.I-3M.I-I 03-01	ИФ3-40	12	3755	
Ф3	I.220.I-3M.I-I 02-01	Ф2-40	3	2575	
Ф4	I.220.I-3M.I-I 03-01	ИФ3-40	6	3755	
Ф6		ИФД9-40	1		
Ф12		ИФД9-40	2		
Ф13		ФД9-40	2		
		КОЛОННА			
KI	I.220.I-3M.2-I 13-01	КОЗТ 3.33-25.3	4	2373	
I.220.I-3M.0-I.4 23					
НАЧ.ОТД.	Шевченко	ЗДАНИЕ 3Т 4.6-ЗАЛ(12) 4Т 4.6-ЗАЛ(12)	СТАДИЯ	ЛИСТ	ЛИСТОВ
И.КОНТР.	Егунов		Р	1	5
ГЛ.СПЕЦ.	Рудавин		ГОСГРАЖДАНСТРОИ		
ПРОВЕРИЛ	Зуенко		КиевЗНИИЭП		
РАЗРАБ.	Безгудова				

МАРКА ПОЗ	ОБОЗНАЧЕНИЕ	НАИМЕНОВАНИЕ	КОП.	МАССА ЕД. КГ	ПРИМЕЧАНИЕ
K2	I.220.I-3M.2-I 13-01	КОЗТ 3.33-25.3	3	2373	
K3	I.220.I-3M.2-I 11-04	КДЗТ 3.33-30.3	6	2496	
K4	I.220.I-3M.2-I 13-01	КОЗТ 3.33-25.3	2	2373	
K5	I.220.I-3M.2-I 17-02	КОФЗТ 3.33-40.7	1	2414	
K6	I.220.I-3M.2-I 12	КДЗТ 3.33-40.4	1	2970	
K7	I.220.I-3M.2-I 13	КОЗТ 3.33-25.2	1	2373	
K8	I.220.I-3M.2-I 09-01	КДТ 3.33-25.2	3	786	
K9	I.220.I-3M.2-I 13	КОЗТ 3.33-25.2	1	2373	
K10	I.220.I-3M.2-I 15-06	КДФЗТ 3.33-25.2	2	2396	
K11	I.220.I-3M.2-I 15-09	КДФЗТ 3.33-40.7	1	2490	
K12	I.220.I-3M.2-I 13	КОЗТ 3.33-25.2	3	2373	
K13	I.220.I-3M.2-I 12	КДЗТ 3.33-40.4	4	2970	
K14	I.220.I-3M.2-I 13	КОЗТ 3.33-25.2	1	2373	
K15	I.220.I-3M.2-I 17-02	КОФЗТ 3.33-40.7	2	2414	
		РИГЕЛЬ			
P3	I.020-I/83.3-I 07-02	РОП 4.57-40	15	2070	
P4	I.020-I/83.3-I 02-03	РДП 4.57-70АТУ	17	2600	
P7	I.020-I/83.3-I 10-01	РОП 4.69-40	4	2520	
P8	I.020-I/83.3-I 04-03	РДП 4.69-70АТУ	10	3170	
		СВЯЗЕВАЯ ПЛИТА			
PII	I.04I.I-2.I.200-01	ПК56.I2-6АТИУС(АЛУ)Т-1	24	2000	
PI2	I.04I.I-2.I.400-02	ПК56.I5-6АТИУС(АЛУ)Т-2 I.220.I-3M.0-I.4 23-01 3Т 4.6.30-ЗАЛ(12) 40-4.0	27	2600	
		РОСТВЕРК			
Ф1	I.220.I-3M.I-I 04-01	Ф3-40	4	3625	
Ф2	I.220.I-3M.I-I 03-01	ИФ3-40	12	3755	
Ф3	I.220.I-3M.I-I 02-01	Ф2-40	3	2575	
Ф4	I.220.I-3M.I-I 03-01	ИФ3-40	6	3755	
Ф6		ФД11-40	1		
Ф12		ИФД9-40	2		
Ф13		ФД9-40	2		
I.220.I-3M.0-I.4 23					
ИНВЕН. ПОДЛ.	ПОДПИСЬ И ДАТА	ВЗАИМН. В			
I.220.I-3M.0-I.4 23					

МАРКА ПОЗ	ОБОЗНАЧЕНИЕ	НАИМЕНОВАНИЕ	КОП	МАССА ЕД КГ	ПРИМЕЧАНИЕ
		КОЛОННА			
K1	I.220.I-3M.2-I I3	КОЗТ 3.33-25.2	4	2373	
K2	I.220.I-3M.2-I I3	КОЗТ 3.33-25.2	3	2375	
K3	I.220.I-3M.2-I II-01	КДЗТ 3.33-25.3	6	2496	
K4	I.220.I-3M.2-I I3	КОЗТ 3.33-25.2	2	2375	
K5	I.220.I-3M.2-I I7-02	КОФЗТ 3.33-40.7	1	2414	
K6	I.220.I-3M.2-I II-01	КДЗТ 3.33-25.3	1	2496	
K7	I.220.I-3M.2-I I3	КОЗТ 3.33-25.2	1	2373	
K8	I.220.I-3M.2-I 09	КДПТ 3.33-25.1	3	776	
K9	I.220.I-3M.2-I I3	КОЗТ 3.33-25.2	1	2373	
K10	I.220.I-3M.2-I I5-06	КДФЗТ 3.33-25.2	2	2396	
K11	I.220.I-3M.2-I I5-09	КДФЗТ 3.33-40.7	1	2490	
K12	I.220.I-3M.2-I I3	КОЗТ 3.33-25.2	3	2373	
K13	I.220.I-3M.2-I II-01	КДЗТ 3.33-25.3	4	2496	
K14	I.220.I-3M.2-I I3	КОЗТ 3.33-25.2	1	2373	
K15	I.220.I-3M.2-I I7-02	КОФЗТ 3.33-40.7	2	2414	
		РИГЕЛЬ			
P3	I.020-I/83.3-I 07-02	РОП 4.57-40	15	2070	
P4	I.020-I/83.3-I 02-03	РДП 4.57-70АТУ	17	2600	
P7	I.020-I/83.3-I I0-01	РОП 4.69-40	4	2520	
P8	I.020-I/83.3-I 04-03	РДП 4.69-70АТУ	10	3170	
		СВЯЗЕВАЯ ПЛИТА			
РП1	I.04I.I-2.I.200-01	ПК56.I2-8АТИУС(А1У)Т-1	24	2000	
РП2	I.04I.I-2.I.400-02	ПК56.I5-8АТИУС(А1У)Т-2	27	2600	
		I.220.I-3M.0-I.4 23-02 4Т 4.6.30-ЗАЛ(12) 40-2.5			
		РОСТВЕРК			
Ф1	I.220.I-3M.I-I 04-01	Ф3-40	4	3625	
Ф2	I.220.I-3M.I-I 03-01	Ф3-40	12	3755	
Ф3	I.220.I-3M.I-I 02-01	Ф2-40	3	2575	
Ф4	I.220.I-3M.I-I 05-01	Ф4-40	6	4100	
Ф6		ФДП1-40	1		
Ф12		ФДП1-40	2		
I.220.I-3M.0-I.4 23					ЛИСТ 3

ФОРМАТ А4

МАРКА ПОЗ	ОБОЗНАЧЕНИЕ	НАИМЕНОВАНИЕ	КОП	МАССА ЕД КГ	ПРИМЕЧАНИЕ
		ФД9-40	2		
		КОЛОННА			
K1	I.220.I-3M.2-I 18-01	КО4Т 3.33-40.2	4	3179	
K2	I.220.I-3M.2-I 18-02	КО4Т 3.33-40.3	3	3252	
K3	I.220.I-3M.2-I 20-01	КД4Т 3.33-40.6	6	3394	
K4	I.220.I-3M.2-I 18-02	КО4Т 3.33-40.3	2	3252	
K5	I.220.I-3M.2-I 24-03	КОФ4Т 3.33-40.7	1	3248	
K6	I.220.I-3M.2-I 20-01	КД4Т 3.33-40.6	1	3394	
K7	I.220.I-3M.2-I 18	КО4Т 3.33-30.2	1	3179	
K8	I.220.I-3M.2-I 10	КД2Т 3.33-25.1	3	776	
K9	I.220.I-3M.2-I 18	КО4Т 3.33-30.2	1	3179	
K10	I.220.I-3M.2-I 27	КДФ4Т 3.33-30.2	2	3224	
K11	I.220.I-3M.2-I 29	КДФ4Т 3.33-40.6	1	3349	
K12	I.220.I-3M.2-I 18	КО4Т 3.33-30.2	3	3179	
K13	I.220.I-3M.2-I 20-01	КД4Т 3.33-40.6	4	3394	
K14	I.220.I-3M.2-I 18	КО4Т 3.33-30.2	1	3179	
K15	I.220.I-3M.2-I 24-02	КОФ4Т 3.33-40.3	2	3199	
		РИГЕЛЬ			
P3	I.020-I/83.3-I 07-02	РОП 4.57-40	21	2070	
P4	I.020-I/83.3-I 02-03	РДП 4.57-70АТУ	30	2600	
P7	I.020-I/83.3-I I0-01	РОП 4.69-40	6	2520	
P8	I.020-I/83.3-I 04-03	РДП 4.69-70АТУ	15	3170	
		СВЯЗЕВАЯ ПЛИТА			
РП1	I.04I.I-2.I.200-01	ПК56.I2-8АТИУС(А1У)Т-1	34	2000	
РП2	I.04I.I-2.I.400-02	ПК56.I5-8АТИУС(А1У)Т-2	44	2600	
		I.220.I-3M.0-I.4 23-03 4Т 4.6.30-ЗАЛ(12) 40-4.0			
		РОСТВЕРК			
Ф1	I.220.I-3M.I-I 04-01	Ф3-40	4	3625	
Ф2	I.220.I-3M.I-I 03-01	Ф3-40	12	3755	
Ф3	I.220.I-3M.I-I 02-01	Ф2-40	3	2575	
Ф4	I.220.I-3M.I-I 05-01	Ф4-40	6	4100	
Ф6		ФДП1-40	1		
I.220.I-3M.0-I.4 23					ЛИСТ 4

23171-04 60

ФОРМАТ А4

МАРКА ПОЗ	ОБОЗНАЧЕНИЕ	НАИМЕНОВАНИЕ	КОЛ	МАССА ЕД КГ	ПРИМЕЧАНИЕ
Ф12		ИФД11-40	2		
Ф13		ФД 9-40	2		
		КОЛОННА			
K1	I.220.I-3M.2-I 18	КО4Т 3.33-30.2	4	3179	
K2	I.220.I-3M.2-I 18-01	КО4Т 3.33-40.2	3	3179	
K3	I.220.I-3M.2-I 18-04	КД4Т 3.33-40.2	6	3269	
K4	I.220.I-3M.2-I 18-01	КО4Т 3.33-40.2	2	3179	
K5	I.220.I-3M.2-I 24-03	КО4Т 3.33-40.7	1	3248	
K6	I.220.I-3M.2-I 18-05	КД4Т 3.33-40.3	1	3343	
K7	I.220.I-3M.2-I 18	КО4Т 3.33-30.2	1	3179	
K8	I.220.I-3M.2-I 10	КД2Т 3.33-25.1	3	1592	
K9	I.220.I-3M.2-I 18	КО4Т 3.33-30.2	1	3179	
K10	I.220.I-3M.2-I 27	КД4Т 3.33-30.2	2	3224	
K11	I.220.I-3M.2-I 27-02	КД4Т 3.33-40.3	1	3297	
K12	I.220.I-3M.2-I 18	КО4Т 3.33-30.2	3	3179	
K13	I.220.I-3M.2-I 18-05	КД4Т 3.33-40.3	4	3343	
K14	I.220.I-3M.2-I 18	КО4Т 3.33-30.2	1	3179	
K15	I.220.I-3M.2-I 24-02	КО4Т 3.33-40.3	2	3199	
		РИГЕЛЬ			
P3	I.020-I/83.3-I 07-02	РОП 4.57-40	21	2070	
P4	I.020-I/83.3-I 02-03	РДП 4.57-70АТУ	30	2600	
P7	I.020-I/83.3-I 10-01	РОП 4.69-40	6	2520	
P8	I.020-I/83.3-I 04-03	РДП 4.69-70АТУ	15	3170	
		СВЯЗЕВАЯ ПЛИТА			
РП1	I.041.I-2.I.200-01	ПК56.12-8А1УС(А1У)Т-1	34	2000	
РП2	I.041.I-2.I.400-02	ПК56.15-8А1УС(А1У)Т-2	44	2600	

I.220.I-3M.0-I.4 23

ЛИСТ

5

ФОРМАТ А 4

МАРКА ПОЗ	ОБОЗНАЧЕНИЕ	НАИМЕНОВАНИЕ	КОЛ	МАССА ЕД КГ	ПРИМЕЧАНИЕ
A3	I.220.I-3M.0-I.4 00Т0	ДОКУМЕНТАЦИЯ ТЕХНИЧЕСКОЕ ОПИСАНИЕ СБОРОЧНЫЕ ЕДИНИЦЫ РИГЕЛЬ			
P1	I.220.I-3M.3-I 03-02	РДП4.53-50	6	2518	
P2	I.220.I-3M.3-I 01-01	РДП4.53-90АТУ	16	2518	
P5	I.220.I-3M.3-I 05	РДП4.65-50	2	3090	
P6	I.220.I-3M.3-I 01	РДП4.65-90АТУ	6	3090	
P9	I.220.I-3M.3-I 09	Р4.57-20	14	1710	
P10	I.020-I/83.3-I 07-01	РОП 4.57-30	8	2070	
P11	I.020-I/83.3-I 10	РОП 4.69-30	2	2520	
P12	I.020-I/83.3-I 04-02	РДП 4.69-60АТУ	6	3170	
P13	I.020-I/83.3-I 02-02	РДП 4.57-60АТУ	8	2600	
		СВЯЗЕВАЯ ПЛИТА			
РП3	I.041.I-2.I.400-01	ПК56.15-8А1УС(А1У)Т-2	13	2600	
	ПЕРЕМЕННЫЕ ДАННЫЕ	ДЛЯ ИСПОЛНЕНИЯ I.220.I-3M.0-I.4 24 ЗТ 4.7.30-ЗАЛ(12) 40-2.5			
		РОСТВЕРК			
Ф1	I.220.I-3M.I-I 04-01	Ф3-40	4	3625	
Ф2	I.220.I-3M.I-I 03-01	ИФ3-40	14	3755	
Ф3	I.220.I-3M.I-I 02-01	Ф2-40	3	2575	
Ф4	I.220.I-3M.I-I 03-01	ИФ3-40	9	3755	
Ф6		ФД11-40	2		
Ф13		ФД9-40	1		
Ф12		ИФД9-40	2		
		КОЛОННА			
K1	I.220.I-3M.2-I.13-03	КОЗТ 3.33-30.2	4	2373	
		I.220.I-3M.0-I.4 24			
НАЧ.ОТД.	Шевченко				
Н.КОНТР.	Егунов				
ГЛ.СПЕЦ.	Рудаків				
ПРОВЕРИЛ	Зуенко				
РАЗРАБ.	Безгудова				
СТАДИЯ	Р	ЛИСТ	1	ЛИСТОВ	5
ЭТАП		ЗДАНИЕ		ГОСГРАЖДАНСТРОЙ	
ЗТ 4.7-ЗАЛ(12)		4Т 4.7-ЗАЛ(12)		КиевЗНИИЭП	

23171-04 61

ФОРМАТ А 4

МАРКА ПОЗ	ОБОЗНАЧЕНИЕ	НАИМЕНОВАНИЕ	КОП	МАССА ЕД КГ	ПРИМЕЧАНИЕ
K2	I.220.I-3M.2-I I3-01	КОЗТ 3.33-25.3	5	2428	
K3	I.220.I-3M.2-I II-04	КДЗТ 3.33-30.3	6	2496	
K4	I.220.I-3M.2-I I3-01	КОЗТ 3.33-25.3	2	2428	
K5	I.220.I-3M.2-I I7-02	КОФЗТ 3.33-40.7	1	2414	
K6	I.220.I-3M.2-I I7-02	КОФЗТ 3.33-40.7	2	2414	
K7	I.220.I-3M.2-I I3	КОЗТ 3.33-25.2	2	2373	
K8	I.220.I-3M.2-I 09	КДПТ 3.33-25.1	3	776	
K9	I.220.I-3M.2-I I2	КДЗТ 3.33-40.4	8	2970	
K10	I.220.I-3M.2-I I3	КОЗТ 3.33-25.2	2	2373	
K11	I.220.I-3M.2-I I5_06	КДФЗТ 3.33-25.2	2	2396	
K12	I.220.I-3M.2-I I5_09	КДФЗТ 3.33-40.7	1	2490	
K13	I.220.I-3M.2-I I3	КОЗТ 3.33-25.2	2	2373	
РИГЕЛЬ					
P3	I.020-I/83.3-I 07-02	РОП 4.57-40	14	2070	
P4	I.020-I/83.3-I 02-03	РДП 4.57-70АТУ	24	2600	
P7	I.020-I/83.3-I 10-01	РОП 4.69-40	4	2520	
P8	I.020-I/83.3-I 04-03	РДП 4.69-70АТУ	12	3170	
СВЯЗЕВАЯ ПЛИТА					
РП1	I.04I.I-2.I.200-01	ПК56.12-8АТИУС(АЛУ)Т-1	30	2000	
РП2	I.04I.I-2.I.400-02	ПК56.15-8АТИУС(АЛУ)Т-2	33	2600	
I.220.I-3M.0-I.4 24-01					
ЗТ 4.7.30-ЗАЛ(12)					
40-4.0					
РОСТВЕРК					
Ф1	I.220.I-3M.I-I 04-01	2Ф3-40	4	3625	
Ф2	I.220.I-3M.I-I 03-01	1Ф3-40	14	3755	
Ф3	I.220.I-3M.I-I 02-01	Ф2-40	3	2575	
Ф4	I.220.I-3M.I-I 03-01	1Ф3-40	9	3755	
Ф6		ФДП-40	2		
Ф13		ФД9-40	1		
Ф12		1ФД9-40	2		
КОЛОННА					
K1	I.220.I-3M.2-I I3	КОЗТ 3.33-25.2	4	2373	
K2	I.220.I-3M.2-I I3_01	КОЗТ 3.33-25.3	5	2428	
I.220.I-3M.0-I.4 24					ЛИСТ
					2

ФОРМАТ А4

МАРКА ПОЗ	ОБОЗНАЧЕНИЕ	НАИМЕНОВАНИЕ	КОП	МАССА ЕД КГ	ПРИМЕЧАНИЕ
K3	I.220.I-3M.2-I II-01	КДЗТ 3.33-25.3	6	2496	
K4	I.220.I-3M.2-I I3-01	КОЗТ 3.33-25.3	2	2428	
K5	I.220.I-3M.2-I I7-02	КОФЗТ 3.33-40.7	1	2414	
K6	I.220.I-3M.2-I I7-02	КОФЗТ 3.33-40.7	2	2414	
K7	I.220.I-3M.2-I I3	КОЗТ 3.33-25.2	2	2373	
K8	I.220.I-3M.2-I 09	КДПТ 3.33-25.1	3	776	
K9	I.220.I-3M.2-I II-01	КДЗТ 3.33-25.3	8	2496	
K10	I.220.I-3M.2-I I3	КОЗТ 3.33-25.2	2	2373	
K11	I.220.I-3M.2-I I5-06	КДФЗТ 3.33-25.2	2	2396	
K12	I.220.I-3M.2-I I5-09	КДФЗТ 3.33-40.7	1	2490	
K13	I.220.I-3M.2-I I3	КОЗТ 3.33-25.2	2	2373	
РИГЕЛЬ					
P3	I.020-I/83.3-I 07-02	РОП 4.57-40	14	2070	
P4	I.020-I/83.3-I 02-03	РДП 4.57-70АТУ	24	2600	
P7	I.020-I/83.3-I 10-01	РОП 4.69-40	4	2520	
P8	I.020-I/83.3-I 04-03	РДП 4.69-70АТУ	12	3170	
СВЯЗЕВАЯ ПЛИТА					
РП1	I.04I.I-2.I.200-01	ПК56.12-8АТИУС(АЛУ)Т-1	30	2000	
РП2	I.04I.I-2.I.400-02	ПК56.15-8АТИУС(АЛУ)Т-2	33	2600	
I.220.I-3M.0-I.4 24-02					
4Т 4.7.30-ЗАЛ(12)					
40-2.5					
РОСТВЕРК					
Ф1	I.220.I-3M.I-I 04-01	2Ф3-40	4	3625	
Ф2	I.220.I-3M.I-I 03-01	1Ф3-40	14	3755	
Ф3	I.220.I-3M.I-I 02-01	Ф2-40	3	2575	
Ф4	I.220.I-3M.I-I 05-01	Ф4-40	9	4100	
Ф6		ФДП-40	2		
Ф13		ФД9-40	1		
Ф12		1ФДП-40	2		
КОЛОННА					
K1	I.220.I-3M.2-I I8-01	КО4Т 3.33-40.2	4	3179	
K2	I.220.I-3M.2-I I8-02	КО4Т 3.33-40.3	5	3252	
K3	I.220.I-3M.2-I I8-05	КД4Т 3.33-40.3	6	3343	
I.220.I-3M.0-I.4 24					ЛИСТ
					3

23171-04 62

ФОРМАТ А4

МАРКА ПОЗ	ОБОЗНАЧЕНИЕ	НАИМЕНОВАНИЕ	КОП	МАССА ЕД КГ	ПРИМЕЧАНИЕ
K4	I.220.I-3M.2-I 18-02	КО4Т 3.33-40.3	2	3252	
K5	I.220.I-3M.2-I 24-03	КОФ4Т 3.33-40.7	1	3248	
K6	I.220.I-3M.2-I 24-03	КОФ4Т 3.33-40.7	2	3248	
K7	I.220.I-3M.2-I 18	КО4Т 3.33-30.2	2	3179	
K8	I.220.I-3M.2-I 10	КД2Т 3.33-25.1	3	1592	
K9	I.220.I-3M.2-I 20-01	КД4Т 3.33-40.6	8	3394	
K10	I.220.I-3M.2-I 18	КО4Т 3.33-30.2	2	3179	
K11	I.220.I-3M.2-I 27	КДФ4Т 3.33-30.2	2	3224	
K12	I.220.I-3M.2-I 29	КДФ4Т 3.33-40.6	1	3349	
K13	I.220.I-3M.2-I 18	КО4Т 3.33-30.2	2	3179	
		РИГЕЛЬ			
P3	I.020-I/83.3-I 07-02	РОП 4.57-40АТУ	20	2070	
P4	I.020-I/83.3-I 02-03	РДП 4.57-70АТУ	40	2600	
P7	I.020-I/83.3-I 10-01	РОП 4.69-40АТУ	6	2520	
P8	I.020-I/83.3-I 04-03	РДП 4.69-70АТУ	18	3170	
		СВЯЗЕВАЯ ПЛИТА			
PП	I.04I.I-2.I.200-01	ПК56.12-8АТУС(А1У)Т-1	42	2000	
PП2	I.04I.I-2.I.400-02	ПК56.15-8АТУС(А1У)Т-2	53	2600	
		I.220.I-3M.0-I.4 24-03 4Т 4.7.30-ЗАЛ(12) 40-4.0			
		РОСТВЕРК			
Ф1	I.220.I-3M.I-I 04-01	Ф3-40	4	3625	
Ф2	I.220.I-3M.I-I 03-01	Ф3-40	14	3755	
Ф3	I.220.I-3M.I-I 02-01	Ф2-40	3	2575	
Ф4	I.220.I-3M.I-I 05-01	Ф4-40	9	4100	
Ф6		ФД11-40	2		
Ф73		ФД9-40	1		
Ф12		ФД11-40	2		
		КОЛОННА			
K1	I.220.I-3M.2-I 18	КО4Т 3.33-30.2	4	3179	
K2	I.220.I-3M.2-I 18-01	КО4Т 3.33-40.2	5	3179	
K3	I.220.I-3M.2-I 18-05	КД4Т 3.33-40.3	6	3343	
K4	I.220.I-3M.2-I 18-01	КО4Т 3.33-40.2	2	3179	
		I.220.I-3M.0-I.4 24			

ЛИСТ
4

ФОРМАТ А4

МАРКА ПОЗ	ОБОЗНАЧЕНИЕ	НАИМЕНОВАНИЕ	КОП	МАССА ЕД КГ	ПРИМЕЧАНИЕ
K5	I.220.I-3M.2-I 24-03	КОФ4Т 3.33-40.7	1	3248	
K6	I.220.I-3M.2-I 24-02	КОФ4Т 3.33-40.3	2	3199	
K7	I.220.I-3M.2-I 18	КО4Т 3.33-30.2	2	3179	
K8	I.220.I-3M.2-I 10	КД2Т 3.33-25.1	3	1592	
K9	I.220.I-3M.2-I 18-05	КД4Т 3.33-40.3	8	3343	
K10	I.220.I-3M.2-I 18	КО4Т 3.33-30.2	2	3179	
K11	I.220.I-3M.2-I 27	КДФ4Т 3.33-30.2	2	3224	
K12	I.220.I-3M.2-I 18-05	КДФ4Т 3.33-40.3	1	3343	
K13	I.220.I-3M.2-I 18	КО4Т 3.33-30.2	2	3179	
		РИГЕЛЬ			
P3	I.020-I/83.3-I 07-02	РОП 4.57-40АТУ	20	2070	
P4	I.020-I/83.3-I 02-03	РДП 4.57-70АТУ	40	2600	
P7	I.020-I/83.3-I 10-01	РОП 4.69-40АТУ	6	2520	
P8	I.020-I/83.3-I 04-03	РДП 4.69-70АТУ	18	3170	
		СВЯЗЕВАЯ ПЛИТА			
PП	I.04I.I-2.I.200-01	ПК56.12-8АТУС(А1У)Т-1	42	2000	
PП2	I.04I.I-2.I.400-02	ПК56.15-8АТУС(А1У)Т-2	53	2600	
		I.220.I-3M.0-I.4 24			

ИНВ № ПОД
ПОДПИСЬ И ДАТА
ВЗАИМ №

САПР
КОНСТРУКЦИОН

ОПЕРАТОР
СИСТЕМЫ

Шеф-Взв
Шеф

ЛИСТ
5

23171-04 63 ФОРМАТ А4

МОНТАЖНЫЙ ПЛАН РОСТВЕРКОВ

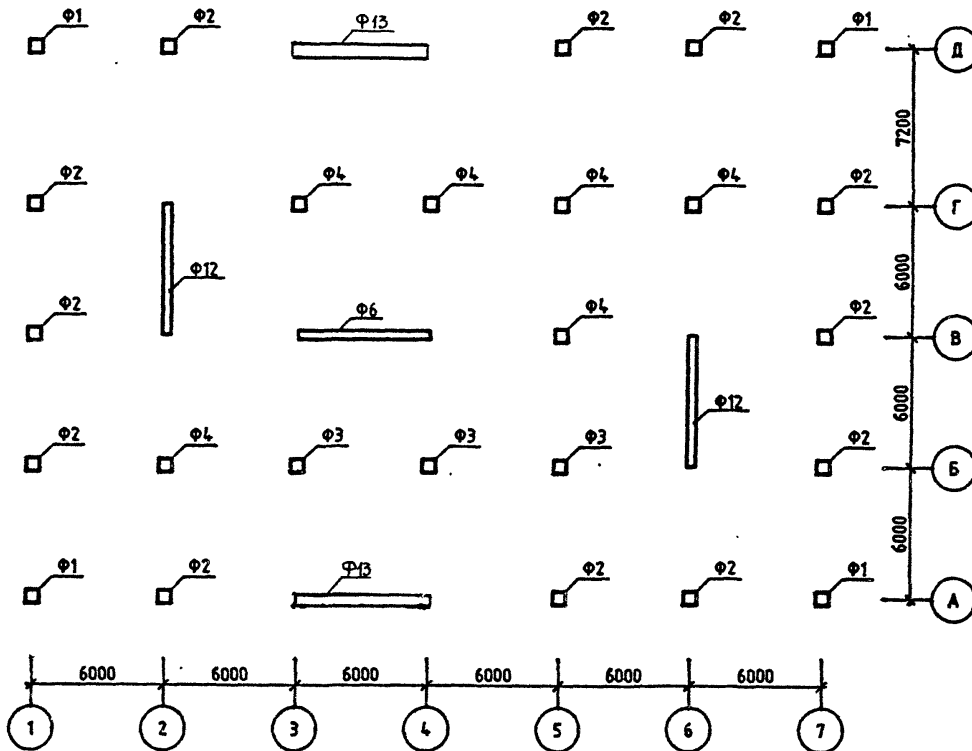

ОБОЗНАЧЕНИЕ	ШИФР ЗДАНИЯ
1.220.1-3М.0-1.423	ЭТ 4.6.30-ЗАЛ(12)40-2.5
-01	ЭТ 4.6.30-ЗАЛ(12)40-4.0
-02	4Т 4.6.30-ЗАЛ(12)40-2.5
-03	4Т 4.6.30-ЗАЛ(12)40-4.0

1.220.1-3М.0-1.4 230Б					
Нач. отд. Шевченко Егупов М.КОНТР. Зуежко ПРОВЕРИЛ Бойко РАЗРАБ Рудякин		ЗДАНИЕ ЭТ 4.6-ЗАЛ(12) 4Т 4.6-ЗАЛ(12)	СТАДИЯ Р	ЛИСТ 1	ЛИСТОВ 6
			ГОСГРАЖДАНСТРОЙ		
			КиевЗНИИЭП		

МОНТАЖНЫЙ ПЛАН КОЛОНН

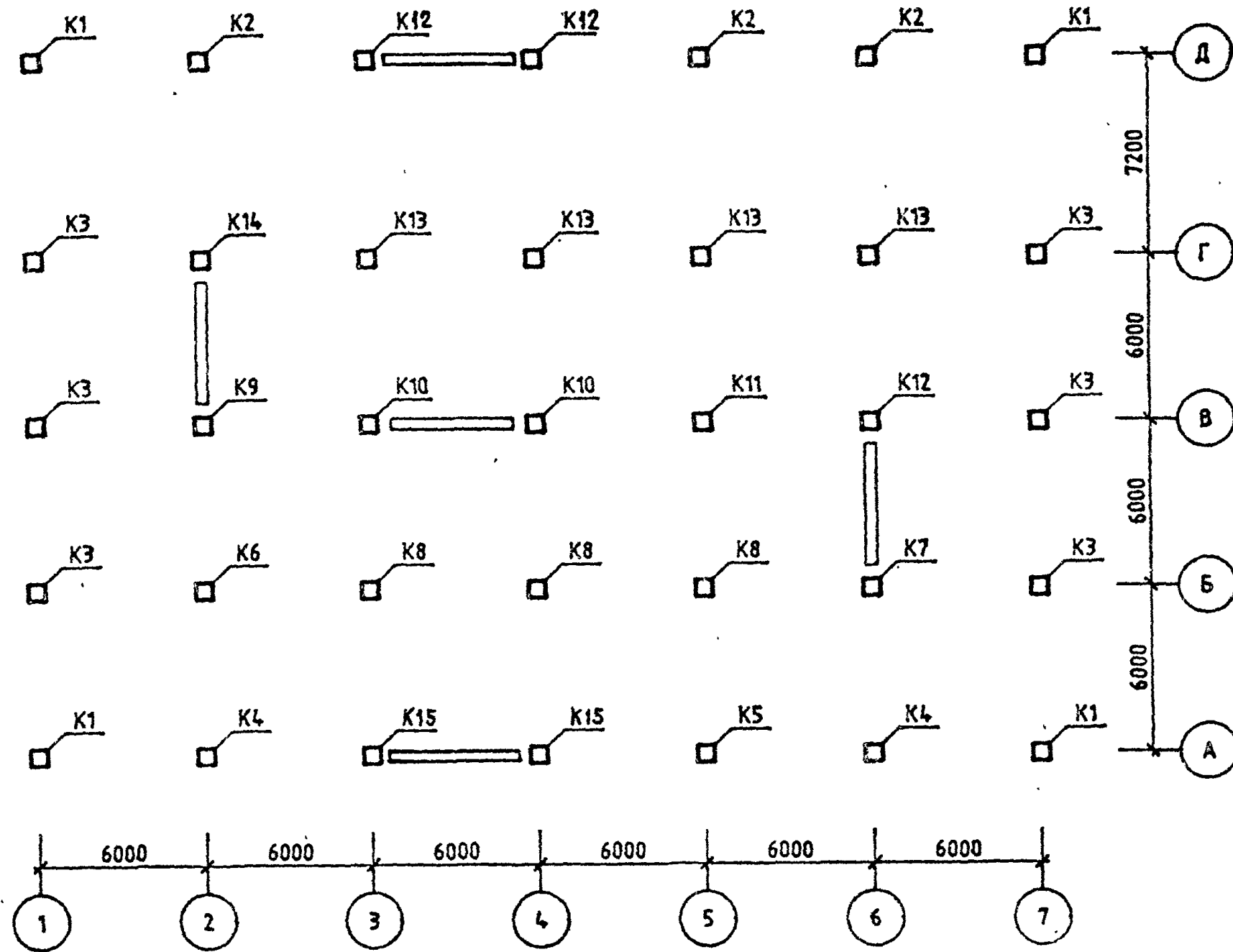

1.220.1-3М.0-1.4 23СБ

ЛИСТ

2

23171-04 65
ФОРМАТ А3

МОНТАЖНЫЙ ПЛАН РИГЕЛЕЙ

ОТМ. -2.32

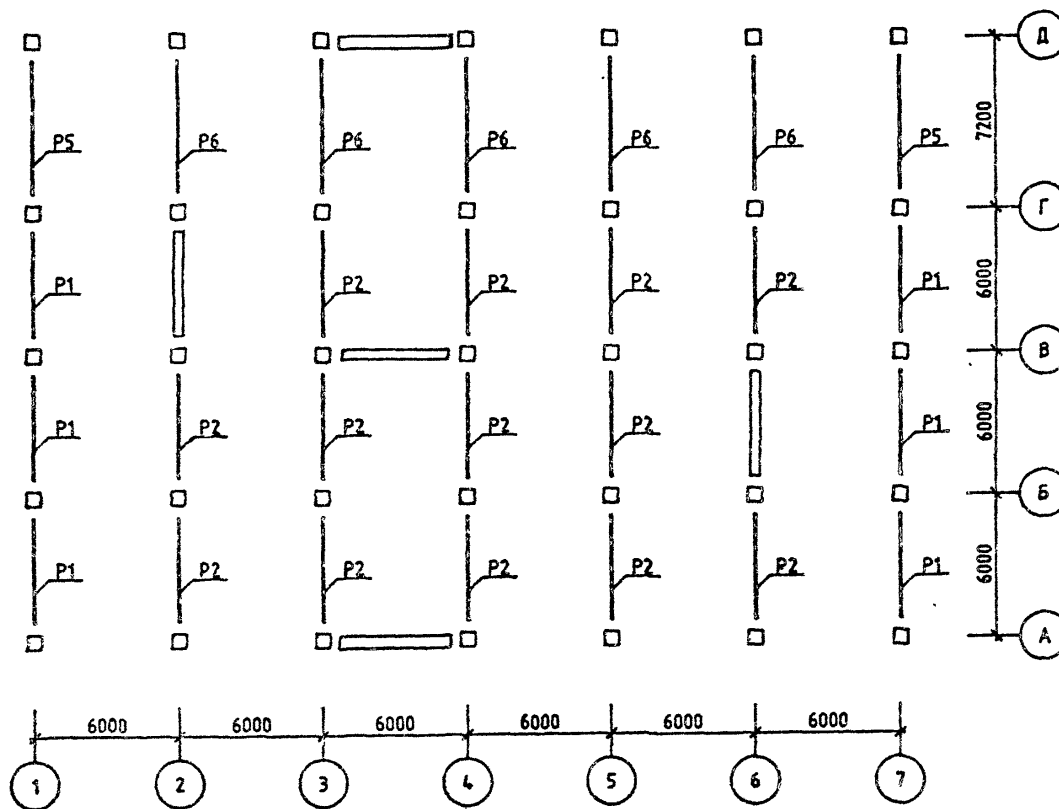

1.220.1-3М.У-1.4 230Б

ЛИСТ
3

23171-04 66 ФОРМАТ А3

МОНТАЖНЫЙ ПЛАН РИГЕЛЕЙ И СВЯЗЕВЫХ ПЛИТ

ОТМ. -0.10 (+3.20)

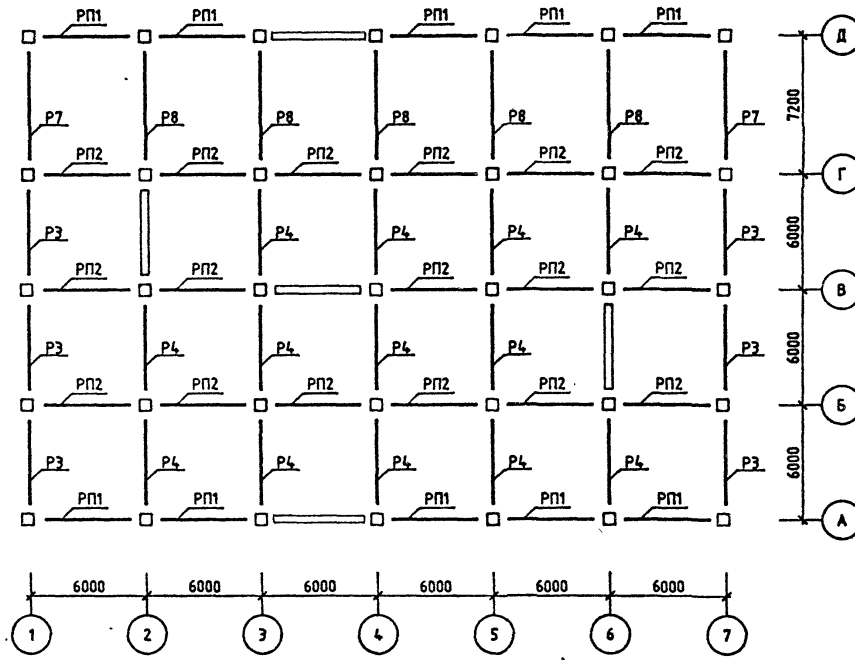

МОНТАЖНЫЙ ПЛАН РИГЕЛЕЙ И СВЯЗЕВЫХ ПЛИТ

ОТМ. +3.20 (+6.50)

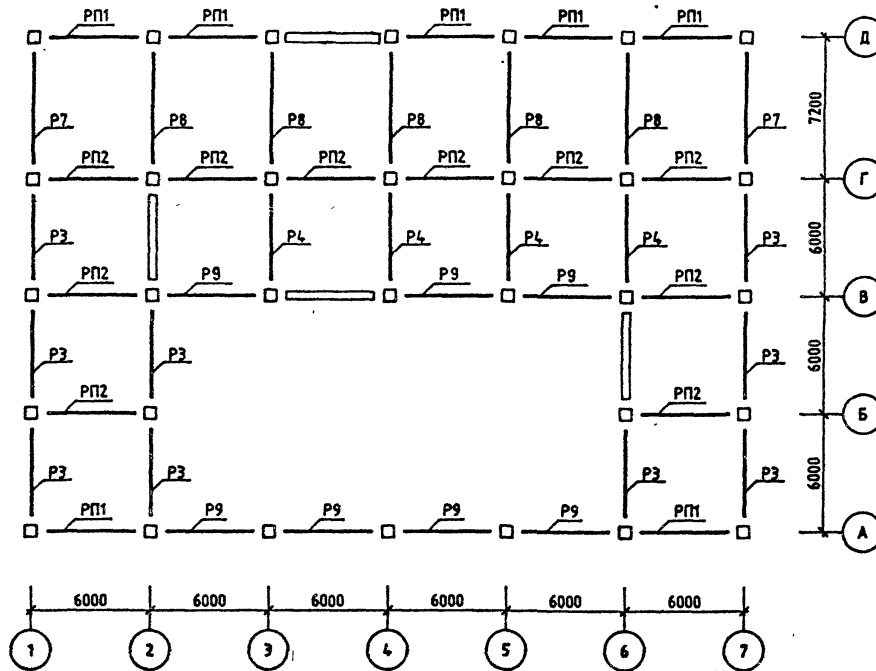

МОНТАЖНЫЙ ПЛАН РИГЕЛЕЙ И СВЯЗЕВЫХ ПЛИТ

ОТМ. +6.50 (+9.80)

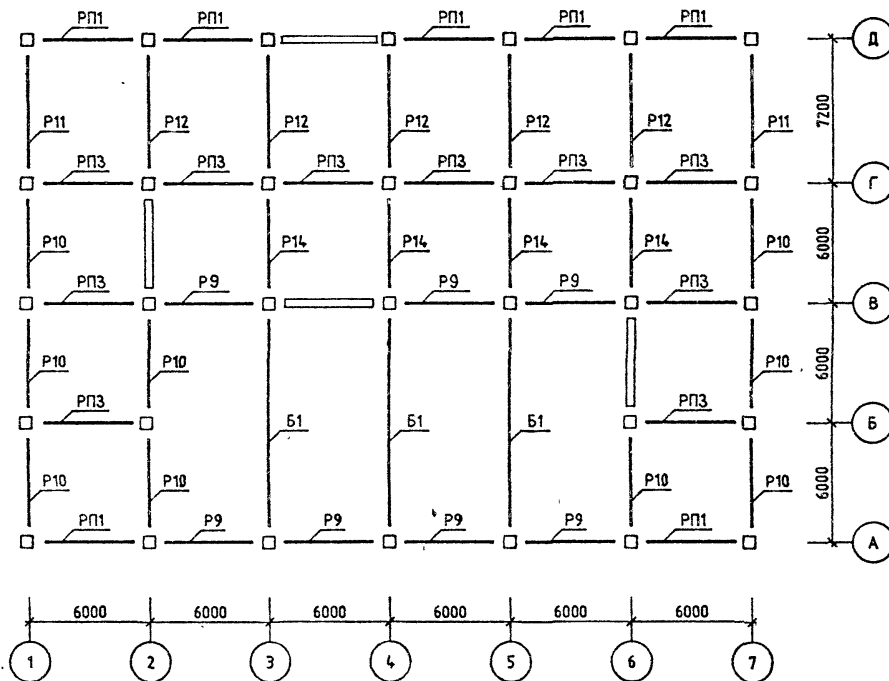

1.220.1-3М.0-1.4 23С6

ЛИСТ

6

23171-04 69

ФОРМАТ А3

МОНТАЖНЫЙ ПЛАН РОСТВЕРКОВ

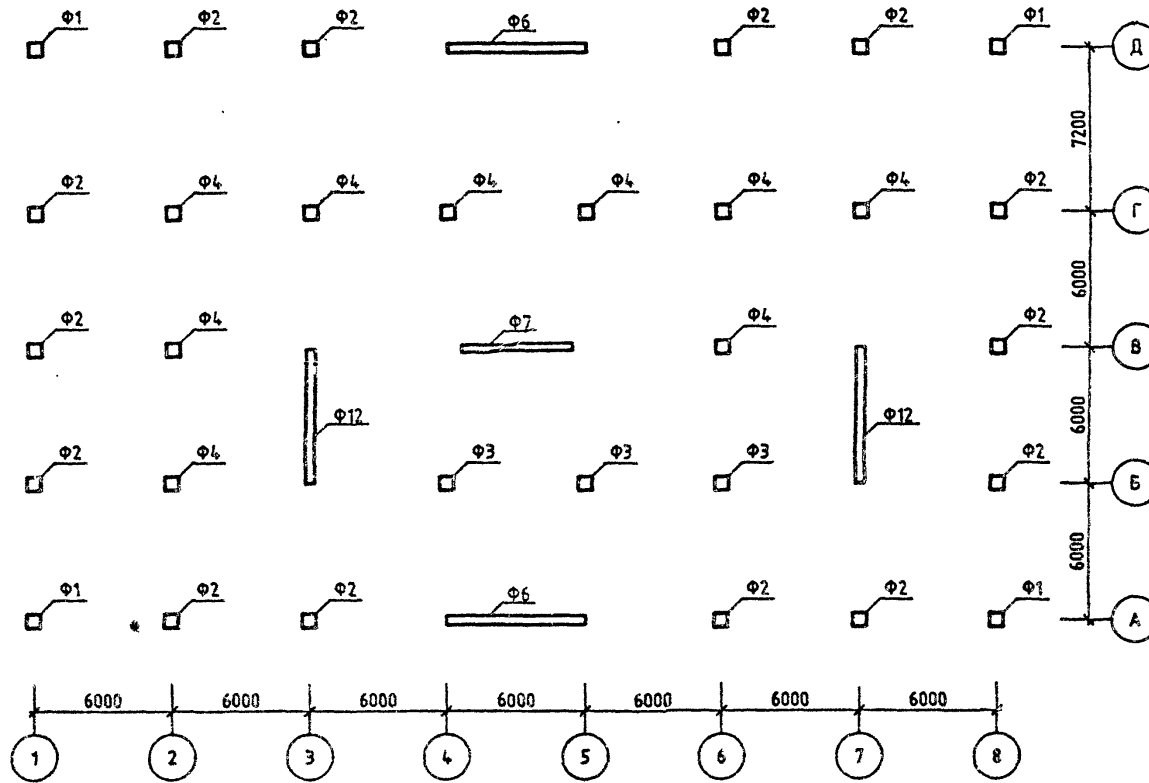

ОБОЗНАЧЕНИЕ	ШИФР ЗДАНИЯ
1.220.1-3М.0-1.4 24	ЭТ 4.7.30-ЗАЛ(12)40-2,5
-01	ЭТ 4.7.30-ЗАЛ(12)40-4,0
-02	ЛТ 4.7.30-ЗАЛ(12)40-2,5
-03	ЛТ 4.7.30-ЗАЛ(12)40-4,0

1.220.1-3М.0-1.4 24СБ					
НОЧ. ОТД. Шевченко		ЗДАНИЕ ЭТ 4.7-ЗАЛ(12) ЛТ 4.7-ЗАЛ(12)	СТАДИЯ	ЛИСТ	ЛИСТОВ
ГИП Егунюв			Р	і	6
Н.КОНТР Зуенко		ГОСГРАЖДАНСТРОЙ КиевЗНИИЭП			
ПРОВЕРИЛ Бойко					
РАЗРАБ Рудаків					

МОНТАЖНЫЙ ПЛАН КОЛОНН

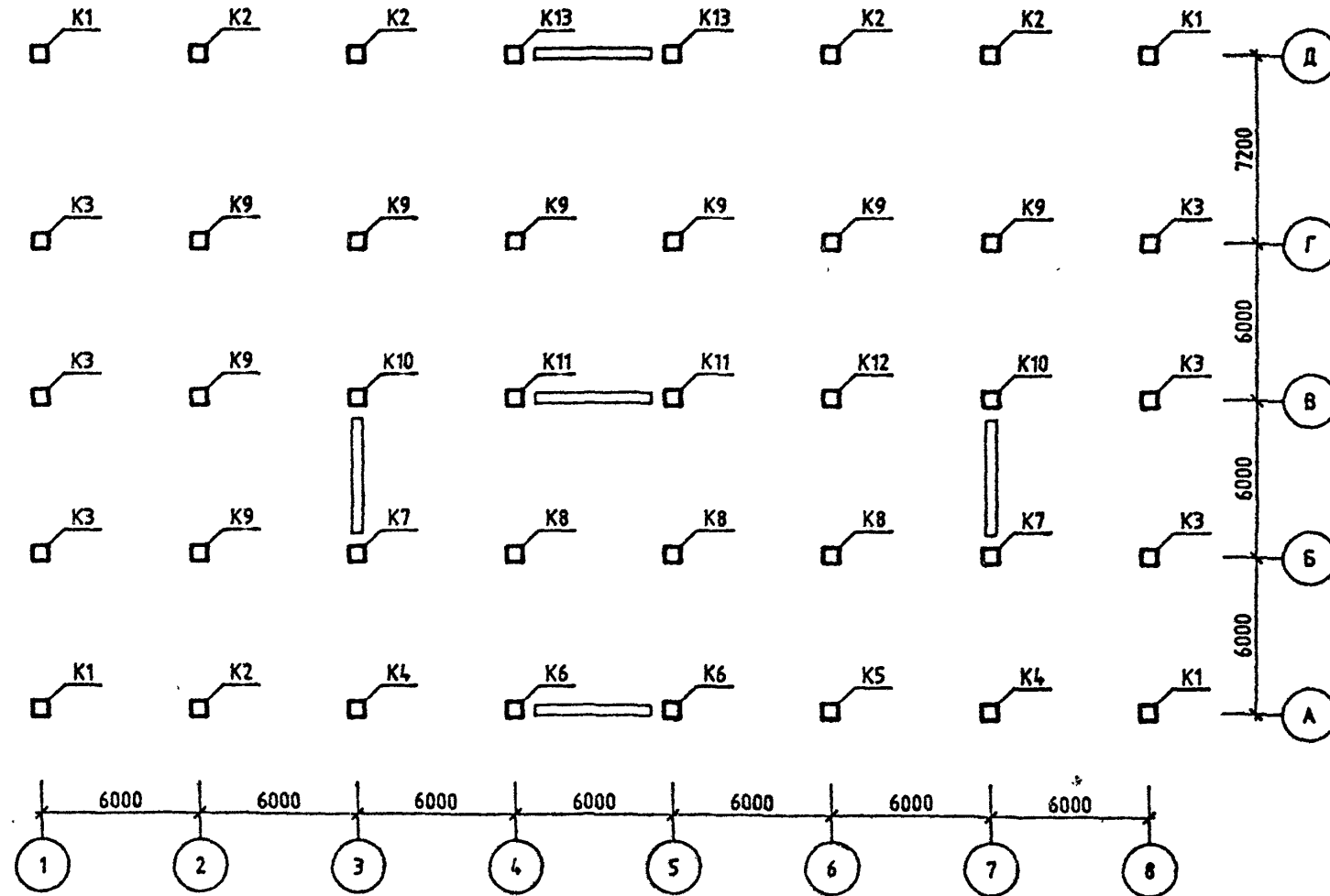

КиевЭНИИЭП

МОНТАЖНЫЙ ПЛАН РИГЕЛЕЙ
ОТМ. -2.32

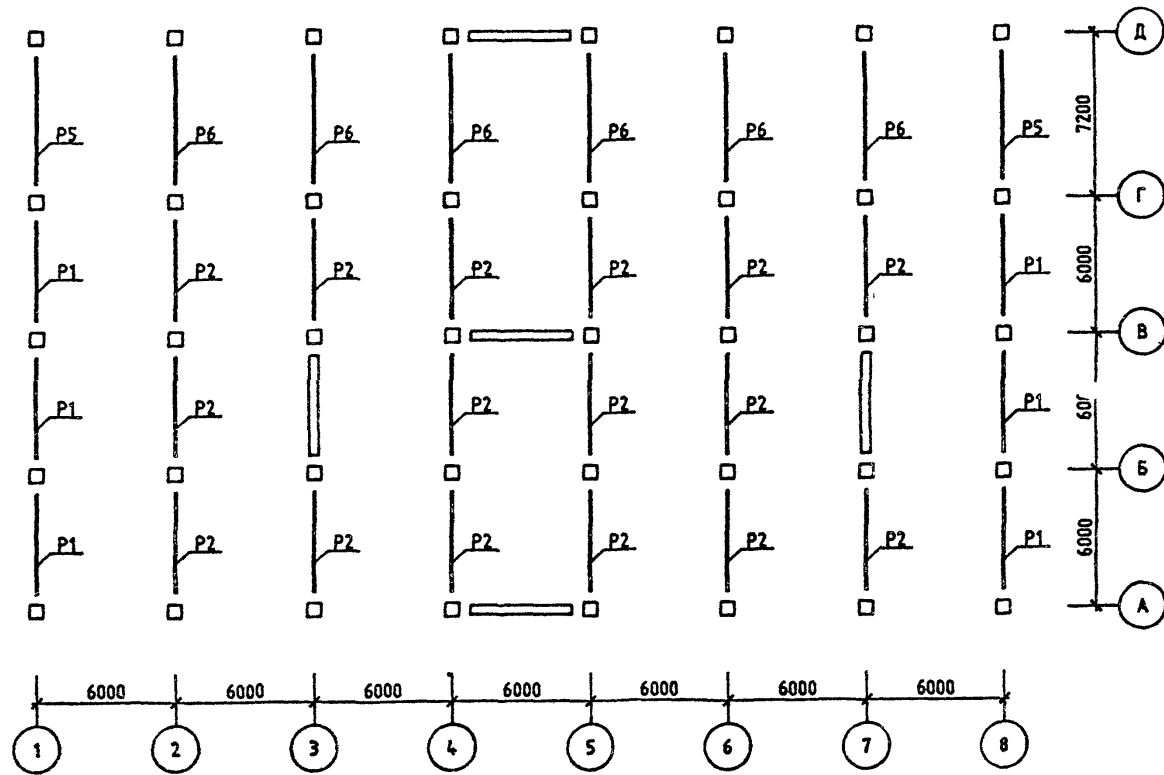

1.220.1-3М.0-1.4 240Б

ЛИСТ
3

МОНТАЖНЫЙ ПЛАН РИГЕЛЕЙ И СВЯЗЕВЫХ ПЛИТ

ОТМ. -0.10 (+3.20)

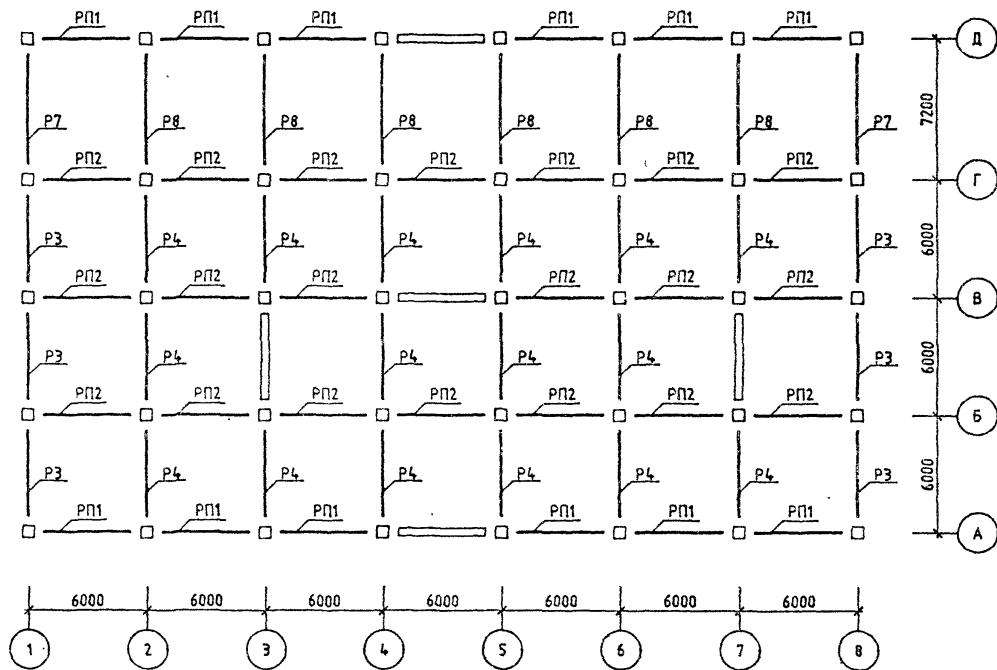

1.220.1-3М.0-1.4 2406

ЛИСТ

4

23171-04 73 ФОРМАТ А3

МОНТАЖНЫЙ ПЛАН РИГЕЛЕЙ И СВЯЗЕВЫХ ПЛИТ

ОТМ. +3.20 (+6.50)

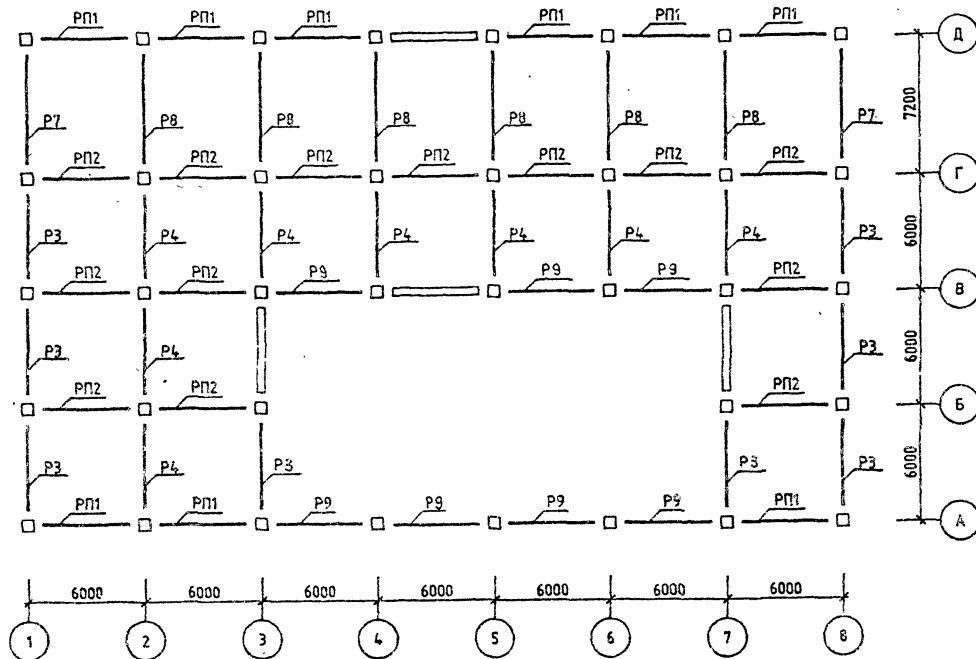

1.220.1-3М.0-1.4 2405

ЛИСТ

5

23171-04 74 ФОРМАТ А3

МОНТАЖНЫЙ ПЛАН РИГЕЛЕЙ И СВЯЗЕВЫХ ПЛИТ

ОТМ. +6.50 (+9.80)

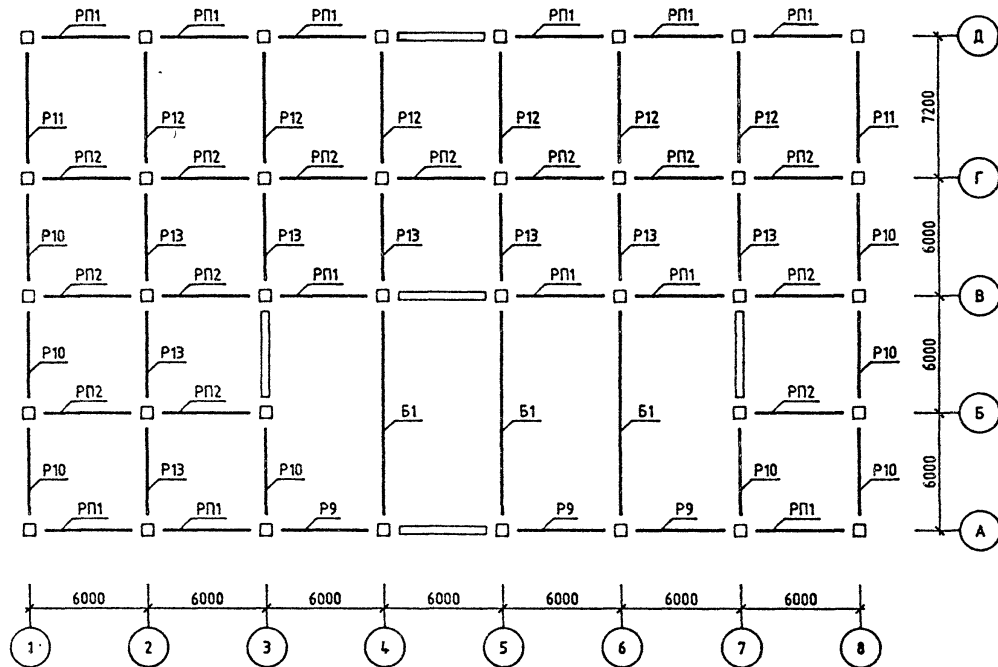

1.220.1-3М.0-1.4 2406

ЛИСТ
6

Номер загрузки	Тип усилия	Номер группы элементов							
		1	2	3	4	5	6	7	8
ЯРУС 1 СЕЧЕНИЕ 1									
1	Н	0.0	0.0	0.0	0.0	-13.9	-17.1	0.0	0.0
	М	7.8	-7.0	11.9	-9.4	-41.8	-11.3	-3.9	-7.7
	В	-2.2	1.9	-3.2	2.4	32.3	2.7	0.8	1.9
	С	-9.9	-15.4	-11.4	-14.1	-24.4	43.4	-4.5	-7.0
	Х	-2.4	3.2	-2.3	2.7	-7.0	10.5	0.3	-1.8
8	Н	0.0	0.0	0.0	0.0	-2.8	-28.1	0.0	0.0
	М	0.2	0.2	0.1	0.2	-1.5	0.1	-0.1	-0.1
	В	0.0	-0.1	0.0	0.0	1.2	0.0	0.0	0.0
	С	-0.5	-0.6	-0.7	-0.9	-1.4	-8.2	-0.4	-0.3
	Х	0.0	-0.1	0.0	-0.1	-0.2	-6.8	-0.1	0.0
9	Н	0.0	0.0	0.0	0.0	23.8	-0.1	0.0	0.0
	М	0.4	0.6	0.7	1.0	8.6	1.5	0.5	-0.2
	В	-0.1	-0.2	-0.2	-0.2	-7.0	-0.4	-0.1	0.2
	С	0.0	0.0	0.0	0.0	0.0	0.0	0.0	0.0
	Х	0.0	0.0	0.0	0.0	0.0	0.0	0.0	0.0
14	Н	104.6	138.8	137.4	175.5	137.7	120.1	82.4	117.4
	М	0.5	0.1	0.6	0.1	4.5	-1.8	0.1	-2.4
	В	-0.7	0.0	-1.4	0.0	-5.0	1.8	0.0	1.8
	С	-0.7	-1.0	0.2	0.2	-0.2	-4.8	0.0	-0.1
	Х	1.0	-1.4	0.0	0.1	0.0	0.0	0.0	0.0
ЯРУС 1 СЕЧЕНИЕ 2									
1	Н	0.0	0.0	0.0	0.0	13.9	17.1	0.0	0.0
	М	-2.2	2.3	-3.9	3.3	-38.8	4.4	1.9	2.9
	В	2.2	-1.9	3.2	-2.4	-32.3	-2.7	-0.8	-1.9
	С	2.9	5.2	3.9	5.0	6.9	40.3	2.2	2.4
	Х	2.4	-3.2	2.3	-2.7	7.0	-10.5	-0.3	1.8
8	Н	0.0	0.0	0.0	0.0	2.8	28.1	0.0	0.0
	М	0.0	-0.1	0.0	-0.1	-1.4	0.0	0.0	0.0
	В	0.0	0.1	0.0	0.0	-1.2	0.0	0.0	0.0
	С	0.2	0.2	0.3	0.4	0.6	-8.8	0.2	0.1
	Х	0.0	0.1	0.0	0.1	0.2	6.8	0.1	0.0
9	Н	0.0	0.0	0.0	0.0	-23.8	0.1	0.0	0.0
	М	-0.1	-0.2	-0.2	-0.4	8.8	-0.7	-0.2	-0.3
	В	0.1	0.2	0.2	0.2	7.0	-0.1	0.1	-0.2
	С	0.0	0.0	0.0	0.0	0.0	0.0	0.0	0.0
	Х	0.0	0.0	0.0	0.0	0.0	0.0	0.0	0.0
14	Н	-104.6	-138.8	-137.4	-175.5	-137.7	-120.1	-82.4	-117.4
	М	1.2	-0.5	3.0	-1.0	8.0	-2.7	0.0	-2.1
	В	0.7	-0.2	1.4	-0.4	5.0	-1.8	0.0	-1.8
	С	1.7	2.9	0.8	0.0	0.0	-8.2	0.0	0.0
	Х	-1.0	1.5	0.0	0.0	0.0	0.0	0.0	0.0

1.220.1-3М.0-1.4 23МУ/			
ГМП	Егузов		
НКОМПР	Бойко		
РУСЛР	Рудавин		
ПРОВЕРИЛ	Футормя		
РАЗРАБ	Зуево		
ЗДАНИЕ		СТАДИЯ	ЛИСТ
3Т 4.6.30-ЗАЛ(12)40-2.5		Р	3
ГОСГРАЖДАНСТРОЙ		КиевЗНИИЭП	

Номер загрузки	Тип усилия	Номер группы элементов							
		1	2	3	4	5	6	7	8
ЯРУС 2 СЕЧЕНИЕ 1									
1	Н	0.0	0.0	0.0	0.0	-10.6	-10.0	0.0	0.0
	М	2.2	-2.3	3.9	-3.3	0.5	-1.6	-1.9	-2.9
	В	-2.2	1.9	-3.2	2.4	-0.3	1.2	0.8	1.9
	С	-2.9	-5.2	-3.9	-5.0	-3.4	-0.5	-2.2	-2.4
	Х	-2.4	3.2	-2.3	2.7	-3.0	-0.2	0.3	-1.8
8	Н	0.0	0.0	0.0	0.0	-0.4	11.1	0.0	0.0
	М	0.0	0.1	0.0	0.1	0.0	0.0	0.0	0.0
	В	0.0	-0.1	0.0	0.0	0.0	0.0	0.0	0.0
	С	-0.2	-0.2	-0.3	-0.4	-0.2	-0.4	-0.2	-0.1
	Х	0.0	-0.1	0.0	-0.1	-0.1	-0.3	-0.1	0.0
9	Н	0.0	0.0	0.0	0.0	7.9	-0.1	0.0	0.0
	М	0.1	0.2	0.2	0.4	0.2	0.2	0.2	0.3
	В	-0.1	-0.2	-0.2	-0.2	-0.2	-0.2	-0.1	0.2
	С	0.0	0.0	0.0	0.0	0.0	0.0	0.0	0.0
	Х	0.0	0.0	0.0	0.0	0.0	0.0	0.0	0.0
14	Н	74.3	102.2	101.5	134.0	56.6	57.2	44.1	84.7
	М	0.9	-0.3	1.7	-0.4	0.4	-0.7	0.0	-1.1
	В	-0.7	0.2	-1.4	0.4	-0.1	0.8	0.0	1.8
	С	-1.2	-1.6	0.0	0.0	0.0	-0.4	0.0	0.0
	Х	-1.0	1.5	0.0	0.0	0.0	-0.5	0.0	0.0
ЯРУС 2 СЕЧЕНИЕ 2									
1	Н	0.0	0.0	0.0	0.0	10.6	10.0	0.0	0.0
	М	3.1	-2.1	3.7	-2.4	0.3	-1.2	0.0	-1.7
	В	2.2	-1.9	3.2	-2.4	0.3	-1.2	-0.7	-1.9
	С	-3.7	-4.5	-3.2	-3.6	-3.8	-0.3	0.0	-1.9
	Х	2.4	-3.2	2.3	-2.7	3.0	0.2	0.3	1.8
8	Н	0.0	0.0	0.0	0.0	0.4	-11.1	0.0	0.0
	М	0.1	0.1	0.0	0.0	0.0	0.0	0.0	0.0
	В	0.0	0.1	0.0	0.0	0.0	0.0	0.0	0.0
	С	-0.1	-0.1	-0.1	-0.2	-0.1	-0.3	0.0	0.0
	Х	0.0	0.1	0.2	0.1	0.1	0.3	0.1	0.0
9	Н	0.0	0.0	0.0	0.0	-7.9	0.1	0.0	0.0
	М	0.1	0.2	0.2	0.2	0.2	0.2	0.0	-0.6
	В	0.1	0.2	0.2	0.2	0.2	0.2	0.1	-0.2
	С	0.0	0.0	0.0	0.0	0.0	0.0	0.0	0.0
	Х	0.0	0.0	0.0	0.0	0.0	0.0	0.0	0.0
14	Н	-74.3	-102.2	-101.5	-134.0	-56.6	-57.2	-44.1	-84.7
	М	0.7	-0.3	1.7	-0.6	0.2	-1.3	0.0	-3.2
	В	0.7	-0.2	1.4	-0.4	0.0	-0.8	0.0	-1.8
	С	-1.2	-2.0	0.1	0.1	-0.1	0.9	0.0	-0.1
	Х	-1.0	1.5	0.0	0.0	0.1	0.5	0.0	0.0

Безупречно
ОПЕРАТОР СИСТЕМЫ
САПР КиевЗНИИЭП

ПОДПИСЬ И ДАТА
ИНВ № ПОДП

1.220.1-3М.0-1.4 23МУ/		ЛИСТ
		2

КиевЗНИИЭ

Номер загрузки	Тип усилия	Номер группы элементов							
		1	2	3	4	5	6	7	8
ЯРУС 3 СЕЧЕНИЕ 1									
1	N	0.0	0.0	0.0	0.0	-3.5	-3.4	0.0	0.0
	MX	-3.1	2.1	-3.7	2.4	0.2	1.8	0.0	1.7
	QY	1.1	-0.8	1.4	-0.9	-0.1	-0.3	0.0	-0.3
	MU	3.7	4.5	3.2	3.6	2.4	-0.6	0.0	1.9
8	QX	1.2	-1.4	1.0	-1.0	0.9	-0.3	0.0	0.6
	N	0.0	0.0	0.0	0.0	-0.2	-6.2	0.0	0.0
	MX	-0.1	-0.1	0.0	0.0	0.0	0.0	0.0	0.0
	QY	0.0	0.0	0.0	0.0	0.0	0.0	0.0	0.0
9	MU	0.1	0.1	0.1	0.2	0.1	-0.4	0.0	0.0
	QX	0.0	0.0	0.1	0.0	0.0	-0.1	0.0	0.0
	N	0.0	0.0	0.0	0.0	4.4	0.0	0.0	0.0
	MX	-0.1	-0.2	-0.2	-0.2	0.1	0.9	0.0	0.6
14	QY	0.1	0.1	0.1	0.1	-0.1	-0.6	0.0	-0.5
	MU	0.0	0.0	0.0	0.0	0.0	0.0	0.0	0.0
	QX	0.0	0.0	0.0	0.0	0.0	0.0	0.0	0.0
	N	49.4	66.8	66.1	85.7	24.2	53.3	0.0	53.6
1	MX	-0.6	-0.2	1.3	-0.5	-0.6	1.9	0.0	1.2
	QY	-0.4	0.1	-0.8	0.3	0.4	-1.3	0.0	-1.2
	MU	-0.8	1.4	-0.1	-0.1	0.1	-0.9	0.0	0.1
	QX	-0.4	0.7	0.0	0.0	0.0	-0.4	0.0	0.0
ЯРУС 3 СЕЧЕНИЕ 2									
1	N	0.0	0.0	0.0	0.0	3.5	3.4	0.0	0.0
	MX	0.6	0.4	-0.8	0.5	0.1	-0.9	0.0	-0.9
	QY	0.8	0.8	-1.4	0.9	0.1	0.3	0.0	0.3
	MU	-0.1	0.9	0.5	0.7	-0.8	-0.4	0.0	0.0
8	QX	-1.2	1.4	-1.0	1.0	-0.9	0.3	0.0	-0.6
	N	0.0	0.0	0.0	0.0	0.2	6.2	0.0	0.0
	MX	0.0	0.0	0.0	0.0	0.0	0.0	0.0	0.0
	QY	0.0	0.0	0.0	0.0	0.0	0.0	0.0	0.0
9	MU	-0.1	0.0	-0.1	0.0	0.0	-0.2	0.0	-0.1
	QX	0.0	0.0	-0.1	-0.1	0.0	0.2	0.0	0.0
	N	0.0	0.0	0.0	0.0	-4.4	0.0	0.0	0.0
	MX	-0.0	0.0	-0.1	-0.1	0.1	1.0	0.0	1.1
14	QY	-0.1	-0.1	-0.1	-0.1	0.1	0.6	0.0	0.5
	MU	0.0	0.0	0.0	0.0	0.0	0.0	0.0	0.0
	QX	0.0	0.0	0.0	0.0	0.0	0.0	0.0	0.0
	N	-49.4	-66.8	-66.1	-85.7	-24.2	-53.3	0.0	-53.6
1	MX	0.8	-0.2	1.5	-0.5	-0.8	2.5	0.0	2.9
	QY	0.4	-0.1	0.8	-0.3	-0.4	1.3	0.0	1.2
	MU	0.7	1.0	-0.1	-0.1	0.1	-0.5	0.0	0.1
	QX	0.4	-0.7	0.0	0.0	0.0	-0.3	0.0	0.0

1.220.1-3М.0-1.4 23МУ1

ЛИСТ
3

ФОРМАТ А 4

Номер загрузки	Тип усилия	Номер группы элементов							
		1	2	3	4	5	6	7	8
ЯРУС 1 СЕЧЕНИЕ 1									
1	N	0.0	0.0	0.0	0.0	-19.8	-20.5	0.0	0.0
	MX	4.8	-4.7	8.0	-7.2	-21.7	-6.9	-2.7	-5.0
	QY	-1.7	1.0	-1.6	1.4	10.7	1.3	0.4	1.0
	MU	-6.3	-10.6	-7.8	-11.1	-16.2	21.7	-3.2	-4.0
8	QX	-1.2	1.7	-1.2	1.6	-3.7	3.9	0.2	-0.0
	N	0.0	0.0	0.0	0.0	-3.0	-30.0	0.0	0.0
	MX	0.3	0.4	0.3	0.5	-2.2	0.3	-0.1	-0.0
	QY	-0.1	-0.1	-0.1	-0.1	1.1	-0.1	0.0	0.0
9	MU	-0.9	-1.4	-1.5	-2.3	-3.0	-11.4	-0.9	-0.0
	QX	-0.1	-0.2	-0.1	-0.3	-0.4	-5.7	-0.1	-0.0
	N	0.0	0.0	0.0	0.0	-26.2	-0.1	0.0	0.0
	MX	0.9	1.6	1.6	2.6	13.3	3.4	1.2	0.0
14	QY	-0.2	-0.3	-0.3	-0.5	-6.5	-0.7	-0.2	-0.0
	MU	0.0	0.0	0.0	0.0	0.0	0.0	0.0	0.0
	QX	0.0	0.0	0.0	0.0	0.0	0.0	0.0	0.0
	N	104.6	138.8	137.4	175.5	152.0	134.6	82.4	117.0
1	MX	0.9	-0.3	1.8	-0.4	3.7	-2.4	0.1	-2.0
	QY	-0.6	0.2	-1.3	0.4	-2.6	1.5	0.0	1.0
	MU	-1.2	-2.0	0.1	0.1	-0.2	-3.7	0.0	-0.0
	QX	0.8	-1.3	0.0	0.0	0.0	0.0	0.0	0.0
ЯРУС 1 СЕЧЕНИЕ 2									
1	N	0.0	0.0	0.0	0.0	19.8	20.5	0.0	0.0
	MX	-0.6	0.9	-1.5	1.7	-21.3	1.6	1.0	1.0
	QY	1.1	-1.0	1.6	-1.4	-10.7	-1.2	-0.4	-1.0
	MU	0.8	2.1	1.6	2.6	1.4	21.4	1.2	1.0
8	QX	1.2	-1.7	1.2	-1.6	3.7	4.5	-0.2	0.0
	N	0.0	0.0	0.0	0.0	3.0	30.0	0.0	0.0
	MX	0.0	-0.1	-0.1	-0.1	-2.0	0.0	0.0	0.0
	QY	0.0	0.1	0.1	0.1	-1.1	0.0	0.0	0.0
9	MU	0.1	0.3	0.3	0.6	0.5	-11.4	0.3	0.0
	QX	0.2	0.3	0.1	0.3	0.4	2.0	0.1	0.0
	N	0.0	0.0	0.0	0.0	26.2	0.1	0.0	0.0
	MX	-0.1	-0.3	-0.3	-0.6	12.8	-0.9	-0.4	-0.0
14	QY	0.2	0.3	0.3	0.5	6.5	0.1	0.2	0.0
	MU	0.0	0.0	0.0	0.0	0.0	0.0	0.0	0.0
	QX	0.0	0.0	0.0	0.0	0.0	0.0	0.0	0.0
	N	-104.6	-138.8	-137.4	-175.5	-152.0	-134.6	-82.4	-117.0
1	MX	1.4	-0.6	3.2	-1.1	6.7	-3.4	0.0	-2.0
	QY	0.6	-0.2	1.3	-0.4	2.6	-1.5	0.0	-1.0
	MU	1.9	3.2	0.0	0.0	-0.1	-6.7	0.0	0.0
	QX	-0.8	1.3	0.0	0.0	0.0	0.0	0.0	0.0

1.220.1-3М.0-1.4 23МУ2

ИНВ № ПОДЛ
ГИП Егунов
И КОНТР. Бойко
РУК ГР. Рудавин
ПРОВЕРИЛ Футорная
РАЗРАБ Зуенко

ЗДАНИЕ
3Т 4.6.30-ЗАЛ(12)40-4.0

СТАДИЯ ЛИСТ ЛИСТ
Р 1 3
ГОСГРАЖДАНСТРОЙ
КиевЗНИИЭ

23171-04 77

ФОРМАТ А 4

Номер загрузки	Тип усилия	Номер группы элементов							
		1	2	3	4	5	6	7	8
ЯРУС 2 СЕЧЕНИЕ 1									
1	Н	0.0	0.0	0.0	0.0	3.2	3.0	0.0	0.0
	МХ	0.6	-0.9	1.5	-1.7	0.4	-0.7	-1.0	-1.3
	МУ	-1.1	1.0	-1.6	1.4	-0.3	0.6	0.4	1.1
	КХ	-0.8	-2.1	-1.6	-2.6	-1.5	-0.4	-1.2	-1.0
8	Н	0.0	0.0	0.0	0.0	0.2	10.4	0.0	0.0
	МХ	0.0	0.1	0.1	0.1	0.0	0.0	0.0	0.0
	МУ	-0.1	-0.1	-0.1	-0.1	0.0	0.0	0.0	0.0
	КХ	-0.2	-0.3	-0.1	-0.3	-0.2	-0.2	-0.1	-0.1
9	Н	0.0	0.0	0.0	0.0	6.2	0.0	0.0	0.0
	МХ	0.1	0.3	0.3	0.6	0.0	0.3	0.4	0.5
	МУ	-0.2	-0.3	-0.3	-0.5	0.0	-0.3	-0.2	-0.1
	КХ	0.0	0.0	0.0	0.0	0.0	0.0	0.0	0.0
14	Н	74.3	102.2	101.5	134.0	62.3	56.4	44.1	84.7
	МХ	0.7	-0.2	1.4	-0.4	0.6	-0.5	0.0	-0.5
	МУ	-0.6	0.2	-1.2	0.4	-0.3	-0.7	0.0	1.4
	КХ	-0.9	-1.3	0.0	0.0	0.0	-0.6	0.0	0.0
ЯРУС 2 СЕЧЕНИЕ 2									
1	Н	0.0	0.0	0.0	0.0	-3.2	-3.0	0.0	0.0
	МХ	2.0	-1.4	2.3	-1.6	0.3	-0.7	0.0	-1.2
	МУ	1.1	-1.0	1.6	-1.4	0.3	-0.6	-0.4	-1.1
	КХ	-2.4	-3.0	-2.1	-2.5	-2.4	-0.4	0.0	-1.2
8	Н	0.0	0.0	0.0	0.0	-0.2	-10.4	0.0	0.0
	МХ	0.1	0.1	-0.1	0.1	0.0	0.0	0.0	0.0
	МУ	-0.1	-0.1	-0.1	-0.1	0.0	0.0	0.0	0.0
	КХ	0.1	0.2	0.2	0.3	0.2	0.2	0.1	0.1
9	Н	0.0	0.0	0.0	0.0	-6.2	0.0	0.0	0.0
	МХ	0.3	0.4	0.4	0.6	0.0	0.5	0.0	-0.4
	МУ	0.2	0.3	0.3	0.5	0.0	0.3	0.2	0.1
	КХ	0.0	0.0	0.0	0.0	0.0	0.0	0.0	0.0
14	Н	-74.3	-102.2	-101.5	-134.0	-62.3	-56.4	-44.1	-84.7
	МХ	0.6	-0.3	1.5	-0.5	0.1	-1.1	0.0	-2.9
	МУ	0.6	-0.2	1.3	-0.4	-0.1	-0.7	0.0	-1.4
	КХ	1.0	-1.8	0.1	0.1	-0.1	1.0	0.0	-0.1

1.220.1-3Ж.0-1.4 23МУ2

ЛИСТ

2

ФОРМАТ А4

Номер загрузки	Тип усилия	Номер группы элементов							
		1	2	3	4	5	6	7	8
ЯРУС 3 СЕЧЕНИЕ 1									
1	Н	0.0	0.0	0.0	0.0	1.8	1.8	0.0	0.0
	МХ	-2.0	1.4	-2.3	1.6	0.1	1.4	0.0	1.2
	МУ	0.7	-0.5	0.9	-0.6	-0.1	-0.2	0.0	-0.2
	КХ	2.4	3.0	2.1	2.5	1.8	-0.5	0.0	1.2
8	Н	0.0	0.0	0.0	0.0	-0.2	6.2	0.0	0.0
	МХ	-0.1	-0.1	0.1	-0.1	0.0	0.0	0.0	0.0
	МУ	0.1	0.1	0.0	0.0	0.0	0.0	0.0	0.0
	КХ	0.3	0.3	0.4	0.4	0.3	-0.5	0.0	0.1
9	Н	0.0	0.0	0.0	0.0	4.1	0.0	0.0	0.0
	МХ	-0.3	-0.4	-0.4	-0.6	0.1	0.7	0.0	0.4
	МУ	0.1	0.2	0.2	0.2	-0.1	-0.5	0.0	-0.5
	КХ	0.0	0.0	0.0	0.0	0.0	0.0	0.0	0.0
14	Н	49.4	66.8	66.1	85.7	25.8	53.3	0.0	53.6
	МХ	0.7	-0.3	1.4	-0.5	-0.5	1.8	0.0	1.0
	МУ	-0.5	0.2	-0.9	0.3	0.4	-1.3	0.0	-1.2
	КХ	-1.0	1.6	-0.1	-0.1	0.1	-0.9	0.0	0.1
ЯРУС 3 СЕЧЕНИЕ 2									
1	Н	0.0	0.0	0.0	0.0	-1.8	-1.8	0.0	0.0
	МХ	0.4	0.3	0.5	0.4	0.1	-0.7	0.0	-0.6
	МУ	0.5	0.5	0.8	0.6	0.1	0.2	0.0	0.2
	КХ	-0.5	0.6	0.4	0.5	-0.6	-0.3	0.0	0.0
8	Н	0.0	0.0	0.0	0.0	0.2	-6.2	0.0	0.0
	МХ	-0.0	-0.1	0.0	0.0	0.0	0.0	0.0	0.0
	МУ	-0.1	-0.1	0.0	0.0	0.0	0.0	0.0	0.0
	КХ	0.0	-0.1	-0.1	-0.2	-0.1	-0.2	0.0	-0.1
9	Н	0.0	0.0	0.0	0.0	-4.1	0.0	0.0	0.0
	МХ	-0.1	-0.1	-0.1	-0.1	0.1	1.1	0.0	1.2
	МУ	-0.1	-0.2	-0.2	-0.2	0.1	0.5	0.0	0.5
	КХ	0.0	0.0	0.0	0.0	0.0	0.0	0.0	0.0
14	Н	-49.4	-66.8	-66.1	-85.7	-25.8	-53.3	0.0	-53.6
	МХ	0.8	-0.3	1.6	-0.5	-0.7	2.5	0.0	3.0
	МУ	0.5	-0.2	0.9	-0.3	-0.4	1.3	0.0	1.2
	КХ	0.7	1.1	-0.1	-0.1	0.1	-0.4	0.0	0.1

1.220.1-3Ж.0-1.4 23МУ2

ЛИСТ

3

23171-04 78 ФОРМАТ А4

Номер загрузки	Тип усилня	Номер группы элементов							
		1	2	3	4	5	6	7	8
ЯРУС 1 СЕЧЕНИЕ 1									
1	N	0.0	0.0	0.0	0.0	-16.3	-22.2	0.0	-14.1
	MX	7.9	7.0	12.0	9.3	41.8	-13.9	-3.4	-13.9
	QU	-2.3	-1.9	-3.2	-2.4	-32.3	4.8	1.4	4.8
	MU	-10.0	-15.5	-11.6	-14.1	-24.5	44.4	-6.4	-20.2
	QX	-2.4	-3.8	-2.3	-3.6	5.6	10.5	0.7	10.5
8	N	0.0	0.0	0.0	0.0	-7.2	-39.3	0.0	12.8
	MX	0.2	-0.2	0.2	-0.3	-2.6	0.2	0.1	0.1
	QU	0.0	0.1	0.0	0.1	2.1	-0.1	0.0	0.0
	MU	-0.5	-0.8	-0.8	-1.1	-1.7	-9.7	-0.6	-3.9
	QX	-0.1	-0.2	-0.2	-0.3	-0.3	-8.2	-0.1	-3.1
9	N	0.0	0.0	0.0	0.0	-37.5	0.0	0.0	0.0
	MX	0.5	0.8	0.8	1.2	11.1	1.7	0.8	1.0
	QU	-0.1	-0.2	-0.2	-0.3	-9.2	-0.4	-0.2	-0.3
	MU	0.0	0.0	0.0	0.0	0.0	0.0	0.0	0.0
	QX	0.0	0.0	0.0	0.0	0.0	0.0	0.0	0.0
14	N	129.5	174.1	172.7	223.8	168.2	148.5	126.5	148.5
	MX	0.5	-0.2	0.6	-0.1	-7.3	-0.8	0.0	-0.8
	QU	-0.7	0.3	-1.4	0.4	7.6	1.0	0.0	1.0
	MU	-0.7	-0.8	-0.1	0.0	0.0	-7.5	0.0	3.3
	QX	0.9	-1.4	0.0	0.0	0.0	-3.4	0.0	-3.4
ЯРУС 1 СЕЧЕНИЕ 2									
1	N	0.0	0.0	0.0	0.0	16.3	22.2	0.0	14.1
	MX	-2.2	-2.3	-3.9	-3.3	38.9	2.0	1.8	2.8
	QU	2.3	1.9	3.2	2.4	32.3	-4.8	-1.4	-2.3
	MU	2.9	5.1	3.9	5.0	6.7	41.6	2.2	-19.3
	QX	2.4	3.8	2.3	3.6	-5.6	-10.5	-0.7	1.9
8	N	0.0	0.0	0.0	0.0	7.2	39.3	0.0	-12.8
	MX	-0.1	-0.1	-0.1	0.1	-2.7	-0.1	0.0	0.0
	QU	0.0	0.1	0.0	-0.1	-2.1	0.1	0.0	0.0
	MU	0.2	0.3	0.3	0.4	0.7	-10.8	0.2	-4.0
	QX	0.1	0.2	0.2	0.3	0.3	8.2	0.1	0.1
9	N	0.0	0.0	0.0	0.0	37.5	0.0	0.0	0.0
	MX	-0.2	-0.3	-0.3	-0.4	11.8	-0.7	-0.3	-0.4
	QU	0.1	0.2	0.2	0.3	9.2	0.4	0.2	0.3
	MU	0.0	0.0	0.0	0.0	0.0	0.0	0.0	0.0
	QX	0.0	0.0	0.0	0.0	0.0	0.0	0.0	0.0
14	N	-129.5	-174.1	-172.7	-223.8	-168.2	-148.5	-126.5	-148.5
	MX	1.3	-0.5	3.0	-1.0	12.6	-1.7	0.0	-2.1
	QU	0.7	-0.3	1.4	-0.4	7.8	-1.0	0.0	-0.8
	MU	1.7	2.9	0.0	0.0	0.0	-12.8	0.0	5.6
	QX	-0.9	1.4	0.0	0.0	0.0	-3.5	0.0	0.0

		1.220.1-3М.0-1.4 23МУЗ			
ГИП	Егунов	ЗДАНИЕ 4Т 4.6.30-ЗАЛ(12)40-2.5	СТАДИЯ	ЛИСТ	ЛИСТОВ
Н.КОНТР.	Бойко		Р	1	4
РУК.ГР.	Рудавин		ГОСГРАЖДАНСТРОЙ		
ПРОВЕРИЛ	Футорная		КиевЗНИИЭП		
РАЗРАБ	Зуенко				

ФОРМАТ А4

Номер загрузки	Тип усилня	Номер группы элементов							
		1	2	3	4	5	6	7	8
ЯРУС 2 СЕЧЕНИЕ 1									
1	N	0.0	0.0	0.0	0.0	-9.5	-10.4	0.0	-10.4
	MX	2.2	2.3	3.9	3.3	-0.4	-2.0	-1.8	-2.8
	QU	-2.3	-1.9	-3.2	-2.4	0.3	2.2	1.4	2.3
	MU	-2.9	-5.1	-3.9	-5.0	-3.4	-0.4	-2.2	-2.4
	QX	-2.4	-3.8	-2.3	-3.6	2.4	-0.3	0.7	-1.9
8	N	0.0	0.0	0.0	0.0	-2.3	17.5	0.0	4.2
	MX	0.1	0.1	0.1	-0.1	0.1	0.0	0.0	0.0
	QU	0.0	-0.1	0.0	0.1	-0.1	0.0	0.0	0.0
	MU	-0.2	-0.3	-0.3	-0.4	-0.2	-0.6	-0.2	-0.2
	QX	-0.1	-0.2	-0.2	-0.3	-0.2	-0.4	-0.1	-0.1
9	N	0.0	0.0	0.0	0.0	-14.9	-0.1	0.0	-0.1
	MX	0.2	0.3	0.3	0.4	0.5	0.2	0.3	0.3
	QU	-0.1	-0.2	-0.2	-0.3	-0.3	-0.2	-0.2	-0.3
	MU	0.0	0.0	0.0	0.0	0.0	0.0	0.0	0.0
	QX	0.0	0.0	0.0	0.0	0.0	0.0	0.0	0.0
14	N	99.2	137.5	136.8	182.4	73.0	62.8	88.2	115.7
	MX	0.9	-0.3	1.7	-0.5	0.8	-0.5	0.0	-1.2
	QU	-0.7	0.3	-1.4	0.4	-0.4	0.4	0.0	0.8
	MU	-1.2	-1.6	0.0	0.0	0.0	-0.7	0.0	0.4
	QX	-0.9	1.5	0.0	0.0	0.0	-0.1	0.0	0.0
ЯРУС 2 СЕЧЕНИЕ 2									
1	N	0.0	0.0	0.0	0.0	9.5	10.4	0.0	10.4
	MX	3.2	2.1	3.8	2.4	-0.3	-3.1	-1.6	-3.1
	QU	2.3	1.9	3.2	2.4	-0.3	-2.2	-1.4	-2.2
	MU	-4.0	-4.7	-3.5	-3.6	-4.0	-0.3	-1.8	-2.1
	QX	2.4	3.8	2.3	3.6	-2.4	0.3	-0.7	0.3
8	N	0.0	0.0	0.0	0.0	2.3	-17.5	0.0	-4.2
	MX	0.0	0.0	0.0	0.0	0.1	0.0	0.0	0.0
	QU	0.0	-0.1	0.0	-0.1	0.1	0.0	0.0	0.0
	MU	-0.1	-0.2	-0.2	-0.2	-0.2	-0.4	-0.1	-0.2
	QX	0.1	0.2	0.1	0.3	0.2	0.4	0.1	0.1
9	N	0.0	0.0	0.0	0.0	14.9	0.1	0.0	0.1
	MX	0.1	0.2	0.2	0.2	0.3	0.2	0.1	0.4
	QU	0.1	0.2	0.2	0.3	0.3	0.2	0.2	0.3
	MU	0.0	0.0	0.0	0.0	0.0	0.0	0.0	0.0
	QX	0.0	0.0	0.0	0.0	0.0	0.0	0.0	0.0
14	N	-99.2	-137.5	-136.8	-182.4	-73.0	-62.8	-88.2	-115.7
	MX	0.8	-0.4	1.7	-0.6	0.1	-0.4	0.0	-0.6
	QU	0.7	-0.3	1.4	-0.4	0.4	-0.4	0.0	-0.8
	MU	1.1	1.8	-0.1	0.0	0.0	0.2	0.0	0.2
	QX	-0.9	1.4	0.0	0.0	0.0	0.1	0.0	0.0

Безуглова
 Бейл
 ОПЕРАТОР СИСТЕМЫ
 САПР КиевЗНИИЭП
 ИВМ № ПОДП
 ПОДПИСИ И ДАТА
 ВЗАМ ИВМ №

1.220.1-3М.0-1.4 23МУЗ		ЛИСТ 2
------------------------	--	-----------

23171-04 79 ФОРМАТ А4

Номер загрузки	Тип усилия	Номер группы элементов								
		1	2	3	4	5	6	7	8	
ЯРУС 3 СЕЧЕНИЕ 1										
1	N	0.0	0.0	0.0	0.0	-3.1	-3.0	0.0	-2.4	
	MX	-3.2	-2.1	-3.8	-2.4	-0.1	2.4	1.6	-2.7	
	MU	1.2	0.8	1.4	0.9	0.1	-1.0	-0.5	-0.9	
	QX	4.0	4.7	3.5	3.6	2.7	-0.2	1.8	2.1	
8	N	0.0	0.0	0.0	0.0	-1.1	11.1	0.0	1.8	
	MX	0.0	0.0	0.0	0.0	0.1	0.0	0.0	0.0	
	MU	0.0	0.0	0.0	0.0	0.0	0.0	0.0	0.0	
	QX	0.1	0.2	0.2	0.2	0.1	-0.3	0.1	0.2	
9	N	0.0	0.0	0.0	0.0	8.9	-0.1	0.0	-0.1	
	MX	-0.1	-0.2	-0.2	-0.2	0.2	-0.2	-0.1	-0.4	
	MU	0.1	0.1	0.1	0.1	-0.1	0.1	0.0	0.3	
	QX	0.0	0.0	0.0	0.0	0.0	0.0	0.0	0.0	
14	N	74.3	102.2	101.5	134.0	33.2	45.8	44.1	84.7	
	MX	0.6	-0.2	1.3	-0.4	-0.4	-0.6	0.0	-1.3	
	MU	-0.4	0.1	-0.8	0.3	0.3	0.5	0.0	1.3	
	QX	-0.8	-1.6	0.1	0.0	0.0	0.5	0.0	0.6	
1	ЯРУС 3 СЕЧЕНИЕ 2									
	N	0.0	0.0	0.0	0.0	3.1	3.0	0.0	2.4	
	MX	-0.7	0.5	-0.9	-0.6	-0.1	1.0	0.6	1.0	
	MU	-1.2	0.8	-1.4	-0.9	-0.1	1.0	0.5	1.0	
8	N	0.0	0.0	0.0	0.0	1.1	-11.1	0.0	-1.8	
	MX	0.1	0.1	0.0	0.0	0.0	0.0	0.0	0.0	
	MU	0.0	0.0	0.0	0.0	0.0	0.0	0.0	0.0	
	QX	-0.2	0.1	0.2	0.2	0.1	-0.2	0.0	-0.2	
9	N	0.0	0.0	0.0	0.0	-8.9	0.1	0.0	0.1	
	MX	-0.0	-0.1	-0.1	-0.1	0.2	-0.3	0.0	-0.8	
	MU	0.0	0.0	0.0	0.0	0.1	-0.1	0.0	-0.3	
	QX	0.0	0.0	0.0	0.0	0.0	0.0	0.0	0.0	
14	N	-74.3	-102.2	-101.5	-134.0	-33.2	-45.8	-44.1	-84.7	
	MX	0.6	-0.2	1.4	-0.5	-0.6	-1.0	0.0	-3.0	
	MU	0.4	-0.1	0.8	-0.3	-0.3	-0.5	0.0	-1.3	
	QX	-1.0	-1.8	0.1	0.1	-0.1	1.1	0.0	1.1	

1.220.1-3M.0-1.4 23МУ3

ЛИСТ
3

Номер загрузки	Тип усилия	Номер группы элементов								
		1	2	3	4	5	6	7	8	
ЯРУС 4 СЕЧЕНИЕ 1										
1	N	0.0	0.0	0.0	0.0	-0.7	-0.7	0.0	0.0	
	MX	-0.7	-0.5	0.9	0.6	0.0	0.0	0.0	-0.4	
	MU	-0.2	0.2	-0.3	-0.2	0.0	0.0	0.0	0.1	
	QX	-0.7	-1.0	-0.6	-0.8	0.2	-0.1	0.0	-0.4	
8	N	0.0	0.0	0.0	0.0	-0.3	-6.0	0.0	0.0	
	MX	-0.1	-0.1	0.0	0.0	0.0	0.0	0.0	0.0	
	MU	0.0	0.0	0.0	0.0	0.0	0.0	0.0	0.0	
	QX	-0.2	-0.1	-0.2	-0.2	-0.1	-0.5	0.0	-0.5	
9	N	0.0	0.0	0.0	0.0	4.5	0.0	0.0	0.0	
	MX	0.0	0.1	0.1	0.1	0.2	1.0	0.0	1.0	
	MU	0.0	0.0	0.0	0.0	-0.1	-0.6	0.0	-0.6	
	QX	0.0	0.0	0.0	0.0	0.0	0.0	0.0	0.0	
14	N	49.4	66.8	66.1	85.7	18.3	53.3	0.0	53.6	
	MX	0.7	-0.3	1.6	-0.5	-0.9	1.9	0.0	1.9	
	MU	-0.5	0.2	-1.0	0.3	0.6	-1.3	0.0	-1.3	
	QX	-1.0	1.6	-0.1	-0.1	0.1	1.2	0.0	1.2	
1	ЯРУС 4 СЕЧЕНИЕ 2									
	N	0.0	0.0	0.0	0.0	0.7	0.7	0.0	0.0	
	MX	-0.1	-0.1	0.2	-0.1	0.0	0.0	0.0	0.2	
	MU	-0.2	-0.2	0.3	-0.2	0.0	0.0	0.0	-0.1	
8	N	0.0	0.0	0.0	0.0	0.3	6.0	0.0	0.0	
	MX	0.0	0.0	0.0	0.0	0.0	0.0	0.0	0.0	
	MU	0.0	0.0	0.0	0.0	0.0	0.0	0.0	0.0	
	QX	-0.1	0.1	-0.1	-0.1	0.0	-0.2	0.0	-0.2	
9	N	0.0	0.0	0.0	0.0	-4.5	0.0	0.0	0.0	
	MX	0.0	0.0	0.0	0.0	0.1	0.9	0.0	1.0	
	MU	0.0	0.0	0.0	0.0	0.1	0.6	0.0	0.5	
	QX	0.0	0.0	0.0	0.0	0.0	0.0	0.0	0.0	
14	N	-49.4	-66.8	-66.1	-85.7	-18.3	-53.3	0.0	-53.6	
	MX	0.8	-0.3	1.6	-0.5	-1.0	2.5	0.0	2.9	
	MU	0.5	-0.2	1.0	-0.3	-0.6	1.3	0.0	1.2	
	QX	-0.7	1.1	-0.1	-0.1	0.1	-0.6	0.0	-0.4	

1.220.1-3M.0-1.4 23МУ3

ЛИСТ
4

Лист 3

Безудова
ОПЕРАТОР СИСТЕМЫ
САПР КиевЭНИИЭП

ИНВ № ПОДЛ ПОДПИСЬ И ДАТА ВЗАМ ИНВ №

Номер загрузки	Тип усилия	Номер группы элементов							
		1	2	3	4	5	6	7	8
ЯРУС 1 СЕЧЕНИЕ 1									
1	N	0.0	0.0	0.0	0.0	-20.8	-22.5	0.0	-15.5
	MX	4.8	-4.6	8.1	7.0	21.1	-8.9	-3.6	-8.9
	QY	-1.1	0.9	-1.6	-1.3	-10.5	2.4	0.7	2.4
	MU	-6.4	-10.7	-7.9	-11.1	-16.3	22.1	-4.3	-8.6
	QX	-1.2	1.7	-1.2	-2.1	3.0	3.8	0.4	3.8
8	N	0.0	0.0	0.0	0.0	7.4	-42.5	0.0	13.4
	MX	-0.3	-0.5	-0.4	-0.6	-3.3	0.4	0.2	0.2
	QY	0.1	0.1	0.1	0.1	1.6	-0.1	0.0	-0.1
	MU	-1.1	-1.7	-1.9	-2.9	-3.8	-14.1	-1.4	-5.5
	QX	-0.2	-0.3	-0.3	-0.5	-0.7	-7.1	-0.3	-2.7
9	N	0.0	0.0	0.0	0.0	41.1	0.0	0.0	0.0
	MX	1.1	2.0	2.0	3.3	17.0	4.1	1.9	2.4
	QY	-0.2	-0.4	-0.4	-0.6	-8.4	-0.9	-0.4	-0.6
	MU	0.0	0.0	0.0	0.0	0.0	0.0	0.0	0.0
	QX	0.0	0.0	0.0	0.0	0.0	0.0	0.0	0.0
14	N	129.5	174.1	172.7	223.8	189.5	169.4	126.5	148.5
	MX	0.8	-0.4	1.7	-0.6	-5.6	-1.3	0.0	-1.3
	QY	-0.6	0.2	-1.2	0.4	3.8	0.8	0.0	0.8
	MU	1.2	1.8	-0.1	-0.1	0.0	-5.7	0.0	1.7
	QX	0.8	-1.2	0.0	0.0	0.0	-1.2	0.0	-1.2
ЯРУС 1 СЕЧЕНИЕ 2									
1	N	0.0	0.0	0.0	0.0	20.8	22.5	0.0	15.5
	MX	-0.5	-0.9	-1.5	-1.6	-20.8	-0.8	0.7	1.1
	QY	1.1	0.9	1.6	1.3	-10.5	-2.4	-0.7	-1.2
	MU	0.7	2.0	1.5	2.6	1.2	21.8	0.9	-8.9
	QX	1.2	2.0	1.2	2.1	3.8	-3.8	-0.4	1.0
8	N	0.0	0.0	0.0	0.0	-7.4	42.5	0.0	-13.4
	MX	-0.1	-0.1	0.1	0.2	-3.3	0.0	0.0	0.0
	QY	0.1	0.1	-0.1	-0.1	-1.6	0.1	0.0	0.0
	MU	0.2	0.4	0.4	0.7	0.6	-14.4	0.3	-5.4
	QX	0.2	0.3	0.4	0.5	0.7	7.1	0.3	0.3
9	N	0.0	0.0	0.0	0.0	-41.1	0.0	0.0	0.0
	MX	-0.2	-0.4	-0.4	-0.8	16.8	-0.6	-0.4	-0.4
	QY	0.2	0.4	0.4	0.6	8.4	0.9	0.4	0.4
	MU	0.0	0.0	0.0	0.0	0.0	0.0	0.0	0.0
	QX	0.0	0.0	0.0	0.0	0.0	0.0	0.0	0.0
14	N	-129.5	-174.1	-172.7	-223.8	-189.5	-169.4	-126.5	-148.5
	MX	1.4	-0.5	3.3	-1.0	10.0	-2.0	0.0	-2.1
	QY	0.6	-0.2	1.2	-0.4	3.8	-0.8	0.0	-0.7
	MU	1.9	3.2	0.0	0.0	0.0	-10.2	0.0	3.0
	QX	-0.8	1.2	0.0	0.0	0.0	1.2	0.0	0.0

1.220.1-3М.0-1.4 23МУ4					
ГИП	Егумов		СТАДИЯ	ЛИСТ	ЛИСТОВ
И КОНТР.	Бойко		Р	1	4
РУК ГР	Рудавин		ЗДАНИЕ		
ПРОВЕРИП	Футорная		4Т 4.6.30-ЗАЛ(12)40-4.0		
РАЗРАБ	Зуенко		КиевЗНИИЭП		

ФОРМАТ А4

Номер загрузки	Тип усилия	Номер группы элементов							
		1	2	3	4	5	6	7	8
ЯРУС 2 СЕЧЕНИЕ 1									
1	N	0.0	0.0	0.0	0.0	2.7	3.9	0.0	3.9
	MX	-0.5	0.9	1.5	1.6	-0.4	-0.8	-0.7	-1.1
	QY	-1.1	-0.9	-1.6	-1.3	0.3	1.2	0.7	1.2
	MU	-0.7	-2.0	-1.5	-2.6	-1.6	-0.4	-0.9	-0.9
	QX	-1.2	-2.0	-1.2	-2.1	1.4	-0.2	0.4	-1.0
8	N	0.0	0.0	0.0	0.0	-2.1	16.6	0.0	3.3
	MX	0.1	0.1	-0.1	-0.2	0.0	0.0	0.0	0.0
	QY	-0.1	-0.1	0.1	0.1	0.0	0.0	0.0	0.0
	MU	-0.2	-0.4	-0.4	-0.7	-0.4	-0.4	-0.3	-0.3
	QX	-0.2	-0.3	-0.4	-0.5	-0.4	-0.3	-0.3	-0.3
9	N	0.0	0.0	0.0	0.0	-13.2	-0.1	0.0	-0.1
	MX	0.2	0.4	0.4	0.8	0.2	0.4	0.4	0.4
	QY	-0.2	-0.4	-0.4	-0.6	-0.2	-0.4	-0.4	-0.4
	MU	0.0	0.0	0.0	0.0	0.0	0.0	0.0	0.0
	QX	0.0	0.0	0.0	0.0	0.0	0.0	0.0	0.0
14	N	99.2	137.5	136.8	182.4	81.7	71.2	88.2	115.7
	MX	0.7	-0.2	1.4	-0.4	1.2	-0.4	0.0	-1.1
	QY	-0.6	0.2	-1.2	0.4	-0.7	0.3	0.0	0.7
	MU	-0.9	-1.3	0.0	0.0	0.0	-1.1	0.0	0.4
	QX	-0.8	1.2	0.0	0.0	0.0	-0.1	0.0	0.0
ЯРУС 2 СЕЧЕНИЕ 2									
1	N	0.0	0.0	0.0	0.0	-2.7	-3.9	0.0	-3.9
	MX	2.0	-1.3	2.4	1.6	-0.3	-2.0	-1.0	-2.0
	QY	1.1	-0.9	1.6	1.3	-0.3	-1.2	-0.7	-1.2
	MU	-2.6	-3.1	-2.3	-2.5	-2.6	-0.3	-1.2	-1.4
	QX	1.2	-1.7	1.2	2.1	-1.4	0.2	-0.4	0.2
8	N	0.0	0.0	0.0	0.0	2.1	-16.6	0.0	-3.3
	MX	-0.1	-0.1	-0.1	-0.1	0.0	0.1	0.0	0.0
	QY	-0.1	-0.1	-0.1	-0.1	0.0	0.0	0.0	0.0
	MU	-0.3	-0.4	-0.4	-0.5	-0.5	-0.3	-0.3	-0.3
	QX	0.2	0.3	0.3	0.5	0.3	0.3	0.3	0.3
9	N	0.0	0.0	0.0	0.0	13.2	0.1	0.0	0.1
	MX	0.4	0.5	0.5	0.7	0.2	0.6	0.5	0.6
	QY	0.2	0.4	0.4	0.6	0.2	0.4	0.4	0.4
	MU	0.0	0.0	0.0	0.0	0.0	0.0	0.0	0.0
	QX	0.0	0.0	0.0	0.0	0.0	0.0	0.0	0.0
14	N	-99.2	-137.5	-136.8	-182.4	-81.7	-71.2	-88.2	-115.7
	MX	0.6	-0.3	1.5	-0.6	0.4	-0.3	0.0	-0.6
	QY	0.6	-0.2	1.2	-0.4	0.7	-0.3	0.0	-0.7
	MU	0.9	1.7	-0.1	0.0	0.0	-0.4	0.0	0.2
	QX	-0.8	1.2	0.0	0.0	0.0	0.1	0.0	0.0

Безудова
Бей
ОПЕРАТОР СИСТЕМЫ
САПР
КиевЗНИИЭП
ИНВ № ПОДП
ПОДПИСЬ И ДАТА
ВЗАМ ИНВ №

1.220.1-3М.0-1.4 23МУ4				ЛИСТ
				2

23171-04 81

ФОРМАТ А4

Номер загрузки	Тип усилия	Номер группы элементов							
		1	2	3	4	5	6	7	8
ЯРУС 3 СЕЧЕНИЕ 1									
1	N	0.0	0.0	0.0	0.0	1.7	1.8	0.0	1.8
	MX	-2.0	1.3	-2.4	-1.6	-0.1	1.7	1.0	1.8
	QY	0.8	-0.5	0.9	0.6	0.1	-0.7	-0.3	-0.6
	MU	2.6	3.1	2.3	2.5	1.9	-0.1	1.2	1.4
	QX	0.8	-0.9	0.7	0.9	-0.6	0.0	-0.2	0.5
8	N	0.0	0.0	0.0	0.0	1.1	11.1	0.0	1.7
	MX	0.1	0.1	0.1	0.1	0.0	0.0	0.0	0.0
	QY	0.0	0.0	0.0	0.0	0.0	0.0	0.0	0.0
	MU	0.3	0.4	0.4	0.5	0.3	-0.2	0.3	0.3
	QX	0.1	0.2	0.2	0.2	0.2	-0.1	0.1	0.2
9	N	0.0	0.0	0.0	0.0	8.7	-0.1	0.0	-0.1
	MX	-0.4	-0.5	-0.5	-0.7	0.2	-0.5	-0.5	-0.6
	QY	0.2	0.2	0.2	0.2	-0.1	0.3	0.1	0.4
	MU	0.0	0.0	0.0	0.0	0.0	0.0	0.0	0.0
	QX	0.0	0.0	0.0	0.0	0.0	0.0	0.0	0.0
14	N	74.3	102.2	101.5	134.0	35.6	45.5	44.1	84.7
	MX	0.7	-0.2	1.4	-0.4	0.3	-0.6	0.0	-1.3
	QY	-0.4	0.1	-0.9	0.3	-0.2	0.5	0.0	1.3
	MU	-1.0	-1.7	0.1	0.0	0.0	0.7	0.0	0.7
	QX	-0.6	1.1	0.0	0.0	0.0	-0.5	0.0	0.0
ЯРУС 3 СЕЧЕНИЕ 2									
1	N	0.0	0.0	0.0	0.0	-1.7	-1.8	0.0	-1.8
	MX	-0.4	0.3	-0.6	-0.4	-0.1	0.7	0.0	0.7
	QY	-0.8	0.5	-0.9	-0.6	-0.1	0.7	0.3	0.7
	MU	0.5	0.6	0.4	0.6	0.7	-0.1	0.0	0.2
	QX	-0.8	0.9	-0.7	-0.9	0.6	0.0	0.2	0.0
8	N	0.0	0.0	0.0	0.0	-1.1	-11.1	0.0	-1.7
	MX	0.1	0.0	0.0	0.0	0.0	0.0	0.0	0.0
	QY	0.0	0.0	0.0	0.0	0.0	0.0	0.0	0.0
	MU	0.2	0.2	0.3	0.2	0.2	-0.2	0.0	0.2
	QX	-0.2	-0.2	-0.2	-0.2	-0.2	0.1	-0.1	0.0
9	N	0.0	0.0	0.0	0.0	-8.7	0.1	0.0	0.1
	MX	-0.1	-0.1	-0.1	-0.2	0.2	-0.4	0.0	-0.8
	QY	-0.2	-0.2	-0.2	-0.2	0.1	-0.3	-0.1	-0.4
	MU	0.0	0.0	0.0	0.0	0.0	0.0	0.0	0.0
	QX	0.0	0.0	0.0	0.0	0.0	0.0	0.0	0.0
14	N	-74.3	-102.2	-101.5	-134.0	-35.6	-45.5	-44.1	-84.7
	MX	0.6	-0.2	1.4	-0.5	-0.5	-1.1	0.0	-3.0
	QY	0.4	-0.1	0.9	-0.3	-0.3	-0.5	0.0	-1.3
	MU	-1.0	-1.8	0.1	0.1	-0.1	1.1	0.0	1.1
	QX	-0.6	1.1	0.0	0.0	0.0	0.5	0.0	0.0

1.220.1-3М.0-1.4 23МУ4

ЛИСТ

3

ФОРМАТ А4

Номер загрузки	Тип усилия	Номер группы элементов							
		1	2	3	4	5	6	7	8
ЯРУС 4 СЕЧЕНИЕ 1									
1	N	0.0	0.0	0.0	0.0	0.3	0.2	0.0	0.0
	MX	0.4	-0.3	0.6	0.4	0.0	0.0	0.0	-0.3
	QY	-0.2	0.1	-0.2	-0.1	0.0	0.0	0.0	0.0
	MU	-0.5	-0.6	-0.4	-0.6	0.0	0.0	0.0	-0.2
	QX	-0.2	0.2	-0.1	-0.2	0.0	0.0	0.0	-0.1
8	N	0.0	0.0	0.0	0.0	-0.3	-5.9	0.0	0.0
	MX	-0.1	0.0	0.0	0.0	0.0	0.0	0.0	0.0
	QY	0.0	0.0	0.0	0.0	0.0	0.0	0.0	0.0
	MU	-0.2	-0.2	-0.3	-0.2	-0.1	-0.5	0.0	-0.5
	QX	-0.1	-0.1	-0.1	0.0	0.0	-0.2	0.0	-0.2
9	N	0.0	0.0	0.0	0.0	4.4	0.0	0.0	0.0
	MX	0.1	0.1	0.1	0.2	0.2	1.0	0.0	1.0
	QY	0.0	0.0	0.0	-0.1	-0.1	-0.6	0.0	-0.6
	MU	0.0	0.0	0.0	0.0	0.0	0.0	0.0	0.0
	QX	0.0	0.0	0.0	0.0	0.0	0.0	0.0	0.0
14	N	49.4	66.8	66.1	85.7	18.8	53.3	0.0	53.6
	MX	0.7	-0.3	1.5	-0.5	-0.9	1.9	0.0	1.9
	QY	-0.5	0.2	-0.9	0.3	0.6	-1.3	0.0	-1.3
	MU	-0.9	1.5	-0.1	-0.1	0.1	1.2	0.0	1.2
	QX	-0.4	0.8	0.0	0.0	0.0	-0.5	0.0	-0.5
ЯРУС 4 СЕЧЕНИЕ 2									
1	N	0.0	0.0	0.0	0.0	-0.3	-0.2	0.0	0.0
	MX	-0.1	-0.1	0.1	-0.1	0.0	0.0	0.0	0.1
	QY	-0.1	-0.1	0.2	-0.1	0.0	0.0	0.0	0.0
	MU	-0.1	-0.1	-0.1	-0.1	0.0	0.0	0.0	0.0
	QX	0.2	-0.2	0.1	-0.2	0.0	0.0	0.0	0.1
8	N	0.0	0.0	0.0	0.0	0.3	5.9	0.0	0.0
	MX	0.0	0.0	0.0	0.0	0.0	0.0	0.0	0.0
	QY	0.0	0.0	0.0	0.0	0.0	0.0	0.0	0.0
	MU	-0.1	0.0	-0.1	-0.1	0.0	-0.2	0.0	-0.2
	QX	0.1	0.1	0.0	0.1	0.0	0.2	0.0	0.2
9	N	0.0	0.0	0.0	0.0	-4.4	0.0	0.0	0.0
	MX	0.0	0.0	0.0	0.0	0.1	0.9	0.0	1.0
	QY	0.0	0.0	0.0	0.0	0.1	0.6	0.0	0.5
	MU	0.0	0.0	0.0	0.0	0.0	0.0	0.0	0.0
	QX	0.0	0.0	0.0	0.0	0.0	0.0	0.0	0.0
14	N	-49.4	-66.8	-66.1	-85.7	-18.8	-53.3	0.0	-53.6
	MX	0.8	-0.3	1.6	-0.5	-1.0	2.5	0.0	2.9
	QY	0.5	-0.2	0.9	-0.3	-0.6	1.3	0.0	1.2
	MU	-0.7	1.1	-0.1	-0.1	0.1	-0.6	0.0	-0.4
	QX	0.4	-0.8	0.0	0.0	0.0	-0.5	0.0	-0.1

1.220.1-3М.0-1.4 23МУ4

ЛИСТ

4

23174-04 82 ФОРМАТ А4

номер загрузки	тип усилки	номер группы элементов							
		1	2	3	4	5	6	7	8
ЯРУС 1 СЕЧЕНИЕ 1									
1	N	0.0	0.0	0.0	0.0	-11.6	-5.6	0.0	0.0
	MX	7.5	6.4	12.1	9.5	-40.3	13.7	-2.1	-6.8
	QU	-2.2	-1.7	-3.3	-2.5	31.1	-3.6	0.4	1.7
	MU	9.9	15.9	11.3	16.5	-24.8	33.7	-4.6	-6.6
	QX	-2.8	-4.2	-3.0	-4.2	4.2	13.1	-0.3	-1.7
8	N	0.0	0.0	0.0	0.0	-0.7	-24.8	0.0	0.0
	MX	0.0	0.0	0.0	0.0	-0.2	0.0	0.0	0.0
	QU	0.0	0.0	0.0	0.0	0.1	0.0	0.0	0.0
	MU	-0.2	-0.4	-0.3	-0.5	-0.8	-6.1	-0.3	-0.2
	QX	0.0	-0.1	-0.1	-0.1	-0.1	-1.8	-0.1	0.0
9	N	0.0	0.0	0.0	0.0	32.8	-1.0	0.0	0.0
	MX	0.5	0.8	0.8	1.2	11.1	1.7	0.6	-0.1
	QU	-0.1	-0.2	-0.2	-0.3	-9.1	-0.5	-0.1	0.2
	MU	0.0	0.0	0.1	0.0	0.1	-0.5	0.0	0.1
	QX	0.0	0.0	0.0	0.0	6.0	0.0	0.0	0.0
14	N	104.6	138.8	137.4	175.5	120.1	123.7	82.4	117.4
	MX	0.4	-0.2	-0.5	0.8	4.0	-1.8	0.1	-2.4
	QU	-0.7	0.3	1.1	-0.3	-4.4	1.8	0.0	1.8
	MU	-0.6	0.9	0.2	0.2	-0.2	4.8	0.0	-0.1
	QX	0.9	-1.5	0.0	0.0	0.0	0.0	0.0	0.0
ЯРУС 1 СЕЧЕНИЕ 2									
1	N	0.0	0.0	0.0	0.0	11.6	5.6	0.0	0.0
	MX	-2.1	-2.1	-4.0	-3.4	-37.4	-4.6	1.0	2.5
	QU	2.2	1.7	3.3	2.5	-31.1	3.6	-0.4	-1.7
	MU	2.8	-5.3	-3.7	-5.9	7.0	-31.7	2.2	2.2
	QX	2.8	4.2	3.0	4.2	-4.2	12.6	0.3	1.7
8	N	0.0	0.0	0.0	0.0	0.7	24.8	0.0	0.0
	MX	0.0	0.0	0.0	0.0	0.2	0.0	0.0	0.0
	QU	0.0	0.0	0.0	0.0	0.1	0.0	0.0	0.0
	MU	0.1	0.2	0.2	0.2	0.4	-6.9	0.1	0.1
	QX	0.0	0.1	0.0	0.1	0.2	5.2	0.1	0.0
9	N	0.0	0.0	0.0	0.0	-32.8	1.0	0.0	0.0
	MX	-0.2	-0.3	-0.3	-0.5	11.5	-0.7	-0.3	-0.3
	QU	0.1	0.2	0.2	0.3	9.1	-0.1	0.1	-0.2
	MU	0.0	0.0	0.0	0.0	-0.1	0.5	0.0	0.0
	QX	0.0	0.0	0.0	0.0	0.0	-0.4	0.0	0.0
14	N	-104.6	-138.8	-137.4	-175.5	-120.1	-123.7	-82.4	-117.4
	MX	1.3	-0.5	3.0	-1.0	6.9	-2.7	0.0	-2.1
	QU	0.7	-0.3	1.4	-0.4	4.4	-1.8	0.0	-1.8
	MU	-1.7	2.9	0.0	0.0	0.0	8.2	0.0	0.0
	QX	0.9	-1.5	-0.1	0.0	0.0	0.0	0.0	0.0

1.220.1-3М.0-1.4 24МУ1

ГИП	Егузов	<i>[Signature]</i>
И.КОНТР.	Бойко	<i>[Signature]</i>
РУК.ГР.	Рудавин	<i>[Signature]</i>
ПРОВЕРИЛ	Футорная	<i>[Signature]</i>
РАЗРАБ	Зуенко	<i>[Signature]</i>

ЗДАНИЕ
3Т 4.7.30-ЗАЛ(12)40-2.5

СТАДИЯ	ЛИСТ	ЛИСТОВ
Р	1	3
ГОСГРАЖДАНСТРОЙ КиевЗНИИЭП		

ФОРМАТ А4

номер загрузки	тип усилки	номер группы элементов							
		1	2	3	4	5	6	7	8
ЯРУС 2 СЕЧЕНИЕ 1									
1	N	0.0	0.0	0.0	0.0	-10.6	-9.0	0.0	0.0
	MX	2.1	2.1	4.0	3.4	0.5	2.0	-1.0	-2.5
	QU	-2.2	-1.7	-3.3	-2.5	-0.3	-1.6	0.4	1.7
	MU	-2.8	5.3	3.7	5.9	-3.4	-0.4	-2.2	-2.2
	QX	-2.8	-4.2	-3.0	-4.2	1.8	-0.3	-0.3	-1.7
8	N	0.0	0.0	0.0	0.0	0.3	-10.9	0.0	0.0
	MX	0.0	0.0	0.0	0.0	0.0	0.0	0.0	0.0
	QU	0.0	0.0	0.0	0.0	0.0	0.0	0.0	0.0
	MU	-0.1	-0.2	-0.2	-0.2	-0.1	-0.4	-0.1	-0.1
	QX	0.0	-0.1	0.0	-0.1	0.0	0.0	-0.1	0.0
9	N	0.0	0.0	0.0	0.0	11.5	-0.2	0.0	0.0
	MX	0.2	0.3	0.3	0.5	0.4	0.2	0.3	0.3
	QU	-0.1	-0.2	-0.2	-0.3	-0.3	-0.2	-0.1	0.2
	MU	0.0	0.0	0.0	0.0	0.0	0.0	0.0	0.0
	QX	0.0	0.0	0.0	0.0	0.0	0.0	0.0	0.0
14	N	74.3	102.2	101.5	134.0	47.3	67.8	44.1	84.7
	MX	0.9	-0.3	1.7	-0.5	0.3	0.9	0.0	-1.1
	QU	-0.7	0.3	-1.4	0.4	-0.1	-0.7	0.0	1.8
	MU	1.1	-1.6	0.0	0.0	0.0	-0.4	0.0	0.0
	QX	0.9	-1.5	-0.1	0.1	0.0	0.5	0.0	0.0
ЯРУС 2 СЕЧЕНИЕ 2									
1	N	0.0	0.0	0.0	0.0	10.6	9.0	0.0	0.0
	MX	3.0	1.9	3.8	2.5	0.3	1.9	0.0	-1.5
	QU	2.2	1.7	3.3	2.5	0.3	1.6	-0.4	-1.7
	MU	4.0	4.9	3.5	4.2	-4.0	-0.3	0.0	-1.9
	QX	2.8	4.2	3.0	4.2	-1.8	0.3	-0.3	1.7
8	N	0.0	0.0	0.0	0.0	-0.3	10.9	0.0	0.0
	MX	0.0	0.0	0.0	0.0	0.0	0.0	0.0	0.0
	QU	0.0	0.0	0.0	0.0	0.0	0.0	0.0	0.0
	MU	0.0	0.0	0.0	0.0	0.0	0.0	0.0	0.0
	QX	0.0	0.1	0.1	0.1	0.0	0.0	0.1	0.0
9	N	0.0	0.0	0.0	0.0	-11.5	0.2	0.0	0.0
	MX	0.1	0.2	0.2	0.2	0.3	0.2	0.0	-0.6
	QU	0.1	0.2	0.2	0.3	0.3	0.2	0.1	-0.2
	MU	0.0	0.0	-0.1	0.0	0.0	0.0	0.0	0.0
	QX	0.0	0.0	0.0	0.0	0.0	0.0	0.0	0.0
14	N	-74.3	-102.2	-101.5	-134.0	-47.3	-67.8	-44.1	-84.7
	MX	0.7	-0.3	1.7	-0.6	0.2	-1.3	0.0	-3.2
	QU	0.7	-0.3	1.4	-0.4	0.0	-0.8	0.0	-1.8
	MU	-1.1	2.0	0.1	0.1	-0.1	1.0	0.0	-0.1
	QX	-0.9	1.5	0.1	-0.1	0.0	0.5	0.0	0.0

ИНВ № ПОДЛ	ПОДПИСЬ И ДАТА	ВЗАМ ИНВ №

1.220.1-3М.0-1.4 24МУ1

ЛИСТ
2

23171-04 83 ФОРМАТ А4

Номер загрузки	Тип усилки	Номер группы элементов							
		1	2	3	4	5	6	7	8
ЯРУС 3 СЕЧЕНИЕ 1									
1	N	0.0	0.0	0.0	0.0	-3.5	-2.8	0.0	0.0
	MX	-3.0	-1.9	-3.8	-2.5	0.2	-4.1	0.0	1.5
	MY	1.1	0.7	1.4	0.9	-0.1	1.5	0.0	-0.2
	QX	-4.0	-4.9	-3.5	-4.2	2.7	-0.1	0.0	1.9
		1.4	1.8	1.2	1.5	-0.5	-0.1	0.0	0.6
8	N	0.0	0.0	0.0	0.0	-0.2	-6.1	0.0	0.0
	MX	0.0	0.0	0.0	0.0	0.0	0.0	0.0	0.0
	MY	0.0	0.0	0.0	0.0	0.0	0.0	0.0	0.0
	QX	0.0	0.0	0.0	0.0	0.0	0.0	0.0	0.0
9	N	0.0	0.0	0.0	0.0	6.4	0.0	0.0	0.0
	MX	-0.1	-0.2	-0.2	-0.2	0.2	0.9	0.0	0.6
	MY	0.1	0.1	0.1	0.1	-0.1	-0.6	0.0	-0.5
	QX	0.0	0.0	0.1	0.0	0.0	0.1	0.0	0.0
		0.0	0.0	0.0	0.0	0.0	0.1	0.0	0.0
14	N	49.4	66.8	66.1	85.7	17.8	65.8	0.0	53.6
	MX	0.6	-0.2	1.3	-0.5	-0.5	1.9	0.0	1.2
	MY	-0.4	0.1	-0.9	0.7	0.3	-1.3	0.0	-1.2
	QX	0.8	-1.4	-0.1	-0.1	0.1	-1.1	0.0	0.1
		-0.4	0.7	-0.1	0.0	0.1	-0.4	0.0	0.0
ЯРУС 3 СЕЧЕНИЕ 2									
1	N	0.0	0.0	0.0	0.0	3.5	2.8	0.0	0.0
	MX	0.7	0.5	-0.8	-0.5	0.1	-0.9	0.0	-0.8
	MY	0.9	0.5	-1.4	-0.9	0.1	-1.5	0.0	0.2
	QX	-0.8	-1.0	-0.7	-0.9	0.9	0.0	0.0	0.2
		1.2	1.7	0.8	-1.5	0.5	0.1	0.0	-0.6
8	N	0.0	0.0	0.0	0.0	0.2	6.1	0.0	0.0
	MX	0.0	0.0	0.0	0.0	0.0	0.0	0.0	0.0
	MY	0.0	0.0	0.0	0.0	0.0	0.0	0.0	0.0
	QX	0.0	0.0	-0.1	0.0	0.0	-0.2	0.0	-0.1
		0.0	0.0	0.0	0.0	0.0	0.1	0.0	0.0
9	N	0.0	0.0	0.0	0.0	-6.4	0.0	0.0	0.0
	MX	0.0	-0.1	-0.7	-0.1	0.2	1.0	0.0	1.1
	MY	-0.1	-0.1	-0.1	-0.1	0.1	0.6	0.0	0.5
	QX	0.0	0.0	0.1	0.0	0.0	0.7	0.0	0.0
		0.0	0.0	0.0	0.0	0.0	-0.1	0.0	0.0
14	N	-49.4	-66.8	-66.1	-85.7	-17.8	-65.8	0.0	-53.6
	MX	0.8	-0.2	1.5	-1.7	-0.6	2.5	0.0	2.9
	MY	0.4	-0.1	0.9	-0.7	-0.3	1.3	0.0	1.2
	QX	0.7	-1.1	0.1	-0.1	0.1	-0.5	0.0	0.1
		0.4	-0.7	0.1	0.0	-0.1	-0.4	0.0	0.0

1.220.1-3M.0-1.4 24МУ1

ЛИСТ 3

Номер загрузки	Тип усилки	Номер группы элементов							
		1	2	3	4	5	6	7	8
ЯРУС 1 СЕЧЕНИЕ 1									
1	N	0.0	0.0	0.0	0.0	-19.6	-16.3	0.0	0.0
	MX	4.6	4.2	8.1	7.0	-21.4	8.3	-1.7	-5.0
	MY	-1.0	-0.8	-1.6	-1.3	10.6	-1.8	0.3	1.0
	QX	6.4	11.1	7.9	13.2	-16.9	-15.9	-3.4	-4.6
		-1.4	-2.2	-1.6	-2.5	2.3	-4.1	0.2	-0.9
8	N	0.0	0.0	0.0	0.0	-0.7	-26.4	0.0	0.0
	MX	0.0	0.0	0.0	0.0	-0.1	0.0	0.0	0.0
	MY	0.0	0.0	0.0	0.0	0.1	0.0	0.0	0.0
	QX	-0.5	-0.9	-0.8	-1.5	-1.9	-8.4	-0.7	-0.7
		-0.1	-0.1	-0.1	-0.3	-0.3	-1.8	-0.1	-0.1
9	N	0.0	0.0	0.0	0.0	-35.4	-1.0	0.0	0.0
	MX	1.1	1.9	1.9	3.2	16.3	3.9	1.4	0.8
	MY	-0.2	-0.4	-0.4	-0.6	-8.0	-0.9	-0.2	-0.1
	QX	0.1	0.1	0.2	-0.1	0.2	0.7	0.1	0.1
		0.0	0.0	0.0	0.0	0.0	0.0	0.0	0.0
14	N	104.6	138.8	137.4	175.5	132.3	134.6	82.4	117.4
	MX	0.8	-0.3	1.8	0.7	3.4	-2.4	0.1	-2.9
	MY	-0.6	0.2	-1.3	-0.2	-2.3	1.5	0.0	1.4
	QX	1.2	1.9	0.1	0.1	-0.2	3.7	0.0	-0.1
		0.8	-1.3	0.0	0.0	0.0	0.0	0.0	0.0
ЯРУС 1 СЕЧЕНИЕ 2									
1	N	0.0	0.0	0.0	0.0	19.6	16.3	0.0	0.0
	MX	-0.5	-0.8	-1.5	-1.6	-21.0	1.3	0.6	1.2
	MY	1.0	0.8	1.6	1.3	-10.6	-1.0	-0.3	-1.0
	QX	0.8	2.1	1.5	-3.1	1.4	-16.2	1.3	0.9
		-1.4	2.2	1.6	2.5	-2.3	-4.1	-0.2	0.9
8	N	0.0	0.0	0.0	0.0	0.7	26.4	0.0	0.0
	MX	0.0	0.0	0.0	0.0	-0.2	0.0	0.0	0.0
	MY	0.0	0.0	0.0	0.0	-0.1	0.0	0.0	0.0
	QX	0.1	0.2	0.2	0.4	0.4	-8.6	0.3	0.2
		0.1	0.2	0.1	0.3	0.3	4.2	0.1	0.1
9	N	0.0	0.0	0.0	0.0	35.4	1.0	0.0	0.0
	MX	-0.2	-0.4	-0.4	-0.8	15.9	-0.9	-0.5	-0.6
	MY	0.2	0.4	0.4	0.6	8.0	0.1	0.2	0.1
	QX	0.0	0.0	-0.1	0.0	-0.1	0.7	0.0	0.0
		0.0	0.0	0.0	0.0	0.0	-0.3	0.0	0.0
14	N	-104.6	-138.8	-137.4	-175.5	-132.3	-134.6	-82.4	-117.4
	MX	1.4	-0.5	3.2	-1.1	5.9	-3.4	0.0	-2.8
	MY	0.6	-0.2	1.3	-0.3	2.3	-1.5	0.0	-1.4
	QX	1.9	3.2	0.0	0.0	-0.1	6.7	0.0	0.0
		-0.8	1.3	0.0	0.0	0.0	0.0	0.0	0.0

ИНВ. ПОДЛ. ПОДПИСИ И ДАТА

ИНВ. ПОДЛ.	ПОДПИСИ И ДАТА	ВЗАМ. ИНВ. ПОДЛ.
ГИП	Егулов	
И.КОНТР.	Бойко	
РУК.ГР.	Рудяки	
ПРОВЕРИП	Футормая	
РАЗРАБ	Зуенко	

1.220.1-3M.0-1.4 24МУ2

ЗДАНИЕ
3Т 4.7.30-ЗАЛ(12)40-4.0

СТАДИЯ	ЛИСТ	ЛИСТОВ
Р	1	3

ГОСГРАЖДАНСТРОЙ
КиевЗНИИЭП

Номер загрузки	Тип усилки	Номер группы элементов							
		1	2	3	4	5	6	7	8
ЯРУС 2 СЕЧЕНИЕ 1									
1	N	0.0	0.0	0.0	0.0	3.1	1.3	0.0	0.0
	MX	0.5	0.8	1.5	1.6	0.4	0.8	-0.6	-1.2
	QU	-1.0	-0.8	-1.6	-1.3	-0.3	-0.8	0.3	1.0
	MU	-0.8	-2.1	-1.5	3.1	-1.6	-0.2	-1.3	-0.9
	QX	1.4	-2.2	-1.6	-2.5	1.0	0.1	0.2	-0.9
8	N	0.0	0.0	0.0	0.0	0.3	-10.5	0.0	0.0
	MX	0.0	0.0	0.0	0.0	0.0	0.0	0.0	0.0
	QU	0.0	0.0	0.0	0.0	0.0	0.0	0.0	0.0
	MU	-0.1	-0.2	-0.2	-0.4	-0.2	-0.3	-0.3	-0.2
	QX	-0.1	-0.2	-0.1	-0.3	-0.1	0.1	-0.1	-0.1
9	N	0.0	0.0	0.0	0.0	9.8	-0.1	0.0	0.0
	MX	-0.2	-0.4	-0.4	-0.8	0.1	-0.4	0.5	0.6
	QU	-0.2	-0.4	-0.4	-0.6	-0.1	-0.4	-0.2	-0.1
	MU	0.0	0.0	0.1	0.0	0.0	0.0	0.0	0.0
	QX	0.0	0.0	0.0	0.0	0.0	0.0	0.0	0.0
14	N	74.3	102.2	101.5	134.0	52.2	66.9	44.1	84.7
	MX	0.7	-0.2	1.4	-0.4	0.5	0.7	0.0	-0.5
	QU	-0.6	0.2	-1.2	0.4	-0.2	-0.6	0.0	1.4
	MU	-0.9	-1.3	0.0	0.0	0.0	-0.6	0.0	0.0
	QX	-0.8	1.3	0.0	0.0	0.0	0.6	0.0	0.0
ЯРУС 2 СЕЧЕНИЕ 2									
1	N	0.0	0.0	0.0	0.0	-3.1	-1.3	0.0	0.0
	MX	1.9	1.2	2.4	1.6	0.3	1.1	0.0	-1.1
	QU	1.0	0.8	1.6	1.3	0.3	0.8	-0.3	-1.0
	MU	2.7	3.2	2.3	2.9	-2.7	-0.2	0.0	-1.3
	QX	1.4	2.2	1.6	2.5	-1.0	0.1	-0.2	0.9
8	N	0.0	0.0	0.0	0.0	-0.3	10.5	0.0	0.0
	MX	0.0	0.0	0.0	0.0	0.0	0.0	0.0	0.0
	QU	0.0	0.0	0.0	0.0	0.0	0.0	0.0	0.0
	MU	-0.1	-0.2	-0.2	-0.3	-0.2	-0.2	0.0	-0.1
	QX	0.1	0.2	0.1	0.3	0.1	-0.1	0.1	0.1
9	N	0.0	0.0	0.0	0.0	-9.8	0.1	0.0	0.0
	MX	0.3	0.4	0.5	0.6	0.1	0.5	0.0	-0.4
	QU	-0.2	0.4	-0.4	0.6	0.1	0.4	0.2	0.1
	MU	-0.1	0.0	-0.1	0.0	0.0	0.0	0.0	0.0
	QX	0.0	0.0	0.0	0.0	0.0	0.0	0.0	0.0
14	N	-74.3	-102.2	-101.5	-134.0	-52.2	-66.9	-44.1	-84.7
	MX	0.6	-0.3	1.6	-0.5	0.1	-1.1	0.0	-2.9
	QU	0.6	-0.2	1.3	-0.4	-0.1	-0.7	0.0	-1.4
	MU	0.9	1.8	0.1	0.1	-0.1	1.1	0.0	-0.1
	QX	-0.8	1.3	0.0	0.0	0.0	0.5	0.0	0.0

1.220.1-3M.0-1.4 24МУ2

ЛИСТ
2

ФОРМАТ А4

Номер загрузки	Тип усилки	Номер группы элементов							
		1	2	3	4	5	6	7	8
ЯРУС 3 СЕЧЕНИЕ 1									
1	N	0.0	0.0	0.0	0.0	1.8	1.2	0.0	0.0
	MX	-1.9	-1.2	-2.4	-1.6	0.1	-3.0	0.0	1.1
	QU	0.7	0.4	0.9	0.6	-0.1	1.1	0.0	-0.2
	MU	-2.7	-3.2	-2.3	-2.9	2.0	0.3	0.0	1.3
	QX	0.9	1.2	0.8	1.1	-0.5	0.1	0.0	0.4
8	N	0.0	0.0	0.0	0.0	0.2	-6.2	0.0	0.0
	MX	0.0	0.0	0.0	0.0	0.0	0.0	0.0	0.0
	QU	0.0	0.0	0.0	0.0	0.0	0.0	0.0	0.0
	MU	0.1	0.2	0.2	0.3	0.1	0.0	0.0	0.0
	QX	0.0	0.0	0.0	0.1	0.1	-0.4	0.0	0.1
9	N	0.0	0.0	0.0	0.0	6.2	0.0	0.0	0.0
	MX	-0.3	-0.4	-0.5	-0.6	0.2	0.7	0.0	0.4
	QU	0.1	0.1	0.2	0.2	-0.1	-0.5	0.0	-0.5
	MU	0.1	0.0	0.1	0.0	0.0	0.2	0.0	0.0
	QX	0.0	0.0	0.0	0.0	0.0	0.1	0.0	0.0
14	N	49.4	66.8	66.1	85.7	19.1	65.8	0.0	53.6
	MX	0.7	-0.2	1.4	-0.5	-0.4	1.8	0.0	1.0
	QU	-0.5	0.2	-0.9	0.3	0.3	-1.3	0.0	-1.2
	MU	1.0	-1.6	-0.1	-0.1	0.1	-1.1	0.0	0.1
	QX	-0.4	0.8	0.0	0.0	0.0	0.4	0.0	0.0
ЯРУС 3 СЕЧЕНИЕ 2									
1	N	0.0	0.0	0.0	0.0	-1.8	-1.2	0.0	0.0
	MX	0.5	0.3	-0.5	-0.3	0.1	-0.7	0.0	-0.5
	QU	0.6	0.3	-0.9	-0.6	0.1	-1.1	0.0	0.2
	MU	-0.5	-0.7	-0.5	-0.6	0.7	0.1	0.0	0.1
	QX	0.8	1.1	0.5	-1.1	0.5	-0.1	0.0	-0.4
8	N	0.0	0.0	0.0	0.0	-0.2	6.2	0.0	0.0
	MX	0.0	0.0	0.0	0.0	0.0	0.0	0.0	0.0
	QU	0.0	0.0	0.0	0.0	0.0	0.0	0.0	0.0
	MU	0.0	0.0	0.0	0.0	0.0	0.0	0.0	0.0
	QX	0.0	0.0	-0.1	0.1	0.0	-0.2	0.0	-0.1
9	N	0.0	0.0	0.0	0.0	-6.2	0.0	0.0	0.0
	MX	-0.1	-0.1	-0.1	-0.1	0.2	1.1	0.0	1.2
	QU	-0.1	-0.2	-0.2	-0.2	0.1	0.5	0.0	0.5
	MU	0.1	0.0	0.1	0.0	0.0	0.1	0.0	0.0
	QX	0.0	0.0	0.0	0.0	0.0	-0.1	0.0	0.0
14	N	-49.4	-66.8	-66.1	-85.7	-19.1	-65.8	0.0	-53.6
	MX	0.8	-0.2	1.6	-1.7	-0.6	2.5	0.0	3.0
	QU	0.5	-0.2	0.9	-0.7	-0.3	1.3	0.0	1.2
	MU	0.7	-1.1	0.1	-0.1	0.1	0.4	0.0	0.1
	QX	0.4	-0.8	0.0	0.0	0.0	0.4	0.0	0.0

1.220.1-3M.0-1.4 24МУ2

ЛИСТ
3

23171-04 85
ФОРМАТ А4

К. МЕЛНИКОВ

Безупоно
Без
ОПЕРАТОР СИСТЕМЫ
САПР
КиевЗНИИЭП
ИНВ: ПОДП
ПОДПИСЬ И ДАТА
ВЗЯМ ИНФ

Номер загрузки	Тип усилия	Номер группы элементов							
		1	2	3	4	5	6	7	8
ЯРУС 1 СЕЧЕНИЕ 1									
1	N	0.0	0.0	0.0	0.0	-11.5	-5.3	0.0	0.0
	MX	7.5	6.5	12.2	9.6	-40.1	16.3	-3.0	-7.7
	QY	-2.2	-1.7	-3.3	-2.5	31.0	-5.5	0.8	2.1
	MU	10.0	16.0	11.4	16.6	-24.9	33.9	-6.5	-6.7
	QX	-2.8	-4.2	-3.0	-4.2	4.3	13.4	-0.6	-1.8
8	N	0.0	0.0	0.0	0.0	-0.7	-29.7	0.0	0.0
	MX	0.0	0.0	0.0	0.0	-0.1	0.0	0.0	0.0
	QY	0.0	0.0	0.0	0.0	0.1	0.0	0.0	0.0
	MU	-0.3	-0.5	-0.5	-0.7	-1.0	-6.1	-0.4	-0.5
	QX	-0.1	-0.1	-0.1	-0.2	-0.2	-2.8	-0.1	-0.1
9	N	0.0	0.0	0.0	0.0	-50.3	3.1	0.0	0.0
	MX	0.7	1.1	1.0	1.5	14.0	2.1	0.9	1.0
	QY	-0.2	-0.3	-0.3	-0.4	-11.7	-0.5	-0.2	-0.3
	MU	-0.1	0.1	0.1	0.1	0.1	-0.9	0.1	0.1
	QX	0.0	0.0	0.0	0.0	0.0	0.0	0.0	0.0
14	N	129.5	174.1	172.7	223.8	148.1	148.2	126.5	148.5
	MX	0.5	-0.1	0.6	-0.2	-6.3	1.1	0.0	0.1
	QY	-0.7	0.2	-1.4	0.1	6.7	-1.4	0.0	0.8
	MU	0.7	0.8	-0.1	0.0	0.0	7.4	0.0	0.0
	QX	-0.9	1.5	0.0	0.0	0.0	4.7	0.0	0.0
ЯРУС 1 СЕЧЕНИЕ 2									
1	N	0.0	0.0	0.0	0.0	11.5	5.3	0.0	0.0
	MX	-2.1	-2.1	-4.0	-3.4	-37.3	-2.5	1.0	2.5
	QY	2.2	1.7	3.3	2.5	-31.0	5.5	-0.8	-2.1
	MU	-2.8	-5.3	-3.8	-5.9	6.8	31.8	2.2	2.2
	QX	2.8	4.2	3.0	4.2	-4.3	12.8	0.6	1.8
8	N	0.0	0.0	0.0	0.0	0.7	29.7	0.0	0.0
	MX	0.0	0.0	0.0	0.0	-0.1	0.0	0.0	0.0
	QY	0.0	0.0	0.0	0.0	-0.1	0.0	0.0	0.0
	MU	0.1	0.2	0.2	0.3	0.4	-7.2	0.2	0.2
	QX	0.1	0.1	0.1	0.2	0.2	2.8	0.1	0.1
9	N	0.0	0.0	0.0	0.0	50.3	-3.1	0.0	0.0
	MX	-0.2	-0.4	-0.4	-0.6	15.2	-0.8	-0.4	-0.3
	QY	0.2	0.3	0.3	0.4	11.7	0.5	0.2	0.3
	MU	0.0	0.0	0.0	0.0	0.0	-0.9	0.0	0.0
	QX	0.0	0.0	0.0	0.0	0.0	0.0	0.0	0.0
14	N	-129.5	-174.1	-172.7	-223.8	-148.1	-148.2	-126.5	-148.5
	MX	1.3	-0.5	3.0	-1.0	11.1	2.5	0.0	-2.1
	QY	0.7	-0.2	1.4	-0.4	7.0	1.4	0.0	-0.8
	MU	-1.7	-2.9	0.0	0.0	0.0	12.7	0.0	0.0
	QX	0.9	1.5	0.0	0.0	0.0	-4.1	0.0	0.0

Номер загрузки	Тип усилия	Номер группы элементов							
		1	2	3	4	5	6	7	8
ЯРУС 2 СЕЧЕНИЕ 1									
1	N	0.0	0.0	0.0	0.0	-10.6	-9.0	0.0	0.0
	MX	2.1	2.1	4.0	3.4	0.5	2.4	-1.0	-2.5
	QY	-2.2	-1.7	-3.3	-2.5	-0.3	-2.5	0.8	2.1
	MU	2.8	5.3	3.8	5.9	-3.5	-0.4	-2.2	-2.2
	QX	-2.8	-4.2	-3.0	-4.2	1.9	-0.2	-0.6	-1.8
8	N	0.0	0.0	0.0	0.0	-0.4	-14.4	0.0	0.0
	MX	0.0	0.0	0.0	0.0	0.0	0.0	0.0	0.0
	QY	0.0	0.0	0.0	0.0	0.0	0.0	0.0	0.0
	MU	-0.1	-0.2	-0.2	-0.3	-0.1	-0.5	-0.2	-0.2
	QX	-0.1	-0.1	-0.1	-0.2	-0.1	-0.1	-0.1	-0.1
9	N	0.0	0.0	0.0	0.0	20.7	1.1	0.0	0.0
	MX	0.2	0.4	0.4	0.6	0.7	0.3	0.4	0.3
	QY	-0.2	-0.3	-0.3	-0.4	-0.5	-0.2	-0.2	-0.3
	MU	0.0	0.0	0.0	0.0	0.0	0.0	0.0	0.0
	QX	0.0	0.0	0.0	0.0	0.0	0.0	0.0	0.0
14	N	99.2	137.5	136.8	182.4	62.4	66.5	88.2	115.7
	MX	0.9	-0.3	1.7	-0.5	0.7	0.7	0.0	-1.2
	QY	-0.7	0.2	-1.4	0.5	-0.3	-0.5	0.0	0.8
	MU	1.2	1.6	0.0	0.0	0.0	0.7	0.0	0.0
	QX	0.9	1.5	0.0	0.0	0.0	0.1	0.0	0.0
ЯРУС 2 СЕЧЕНИЕ 2									
1	N	0.0	0.0	0.0	0.0	10.6	9.0	0.0	0.0
	MX	3.1	2.0	3.8	2.5	0.3	3.7	-0.9	-2.4
	QY	2.2	1.7	3.3	2.5	0.3	2.5	-0.8	-2.1
	MU	4.0	4.9	3.5	4.3	-4.1	-0.3	-1.9	-2.0
	QX	2.8	4.2	3.0	4.2	-1.9	0.2	0.6	1.8
8	N	0.0	0.0	0.0	0.0	0.4	14.4	0.0	0.0
	MX	0.0	0.0	0.0	0.0	0.0	0.0	0.0	0.0
	QY	0.0	0.0	0.0	0.0	0.0	0.0	0.0	0.0
	MU	-0.1	-0.1	-0.1	-0.2	-0.1	-0.3	-0.1	-0.1
	QX	0.1	0.1	0.1	0.2	0.1	0.1	0.1	0.1
9	N	0.0	0.0	0.0	0.0	-20.7	-1.1	0.0	0.0
	MX	0.1	0.2	0.2	0.3	0.5	0.2	0.2	0.4
	QY	0.2	0.3	0.2	0.4	0.5	0.2	0.2	0.3
	MU	0.0	0.0	0.0	0.0	0.0	0.0	0.0	0.0
	QX	0.0	0.0	0.0	0.0	0.0	0.0	0.0	0.0
14	N	-99.2	-137.5	-136.8	-182.4	-62.4	-66.5	-88.2	-115.7
	MX	0.8	-0.3	1.7	-0.6	0.1	0.6	0.0	-0.6
	QY	0.7	-0.2	1.4	-0.5	0.3	0.5	0.0	-0.8
	MU	1.1	1.9	-0.1	0.0	0.0	0.2	0.0	0.0
	QX	0.9	-1.5	0.0	0.0	0.0	-0.1	0.0	0.0

Безупрочно
Def
ОПЕРАТОР СИСТЕМ
САПР КиевЗНИИЭП

ИНВ № ПОДЛ
ПОДПИСЬ И ДАТА
ВЗАМ ИНВ №

1.220.1-3М.0-1.4 24МУЗ

ГМП	Егунов	3	СТАДИЯ	ЛИСТ	ЛИСТОВ
М.КОНТР.	Бокко		Р	1	4
РУК.ГР.	Руденко		ГОСГРАЖДАНСТРОЙ		
ПРОВЕРИЛ	Футорман		КиевЗНИИЭП		
РАЗРАБ	Зуевко		ЗДАНИЕ		
			4Т 4.7.30-ЗАЛ(12)40-2.5		

1.220.1-3М.0-1.4 24МУЗ

ЛИСТ	2
------	---

Номер загрузки	Тип усилки	Номер группы элементов							
		1	2	3	4	5	6	7	8
ЯРУС 3 СЕЧЕНИЕ 1									
1	N	0.0	0.0	0.0	0.0	-3.5	-2.8	0.0	0.0
	MX	-3.1	-2.0	-3.8	-2.5	0.2	-2.8	0.9	2.4
	QU	1.1	0.7	1.4	0.9	-0.1	1.2	-0.3	-0.9
	MU	-4.0	-4.9	-3.5	-4.3	2.8	-0.1	1.9	2.0
	QX	1.4	1.8	1.2	1.5	-0.7	0.0	0.2	0.7
8	N	0.0	0.0	0.0	0.0	0.3	-9.7	0.0	0.0
	MX	0.0	0.0	0.0	0.0	0.0	0.0	0.0	0.0
	QU	0.0	0.0	0.0	0.0	0.0	0.0	0.0	0.0
	MU	0.1	0.1	0.1	0.2	0.1	-0.2	0.1	0.1
	QX	0.1	0.1	0.1	0.1	0.1	0.0	0.0	0.1
9	N	0.0	0.0	0.0	0.0	12.6	-0.5	0.0	0.0
	MX	-0.1	-0.2	-0.2	-0.3	0.3	-0.2	-0.2	-0.4
	QU	0.1	0.1	0.1	0.1	-0.2	0.1	0.1	0.3
	MU	0.0	0.0	0.0	0.0	0.0	0.0	0.0	0.0
	QX	0.0	0.0	0.0	0.0	0.0	0.0	0.0	0.0
14	N	74.3	102.2	101.5	134.0	27.1	54.2	44.1	84.7
	MX	0.5	-0.2	1.2	-0.4	0.4	-0.6	0.0	-1.3
	QU	-0.3	0.2	-0.8	0.3	-0.3	0.5	0.0	1.3
	MU	0.8	-1.5	0.1	0.0	0.0	0.7	0.0	0.0
	QX	0.5	-1.0	-0.1	0.0	0.0	-0.5	0.0	0.0
ЯРУС 3 СЕЧЕНИЕ 2									
1	N	0.0	0.0	0.0	0.0	3.5	2.8	0.0	0.0
	MX	-0.7	-0.4	-0.9	-0.6	0.1	-1.2	0.0	0.4
	QU	-1.1	-0.7	-1.4	-0.9	0.1	-1.2	0.3	0.9
	MU	-0.8	-1.1	-0.7	-0.9	1.0	-0.1	0.0	-0.4
	QX	-1.4	-1.8	-1.2	-1.5	0.7	0.0	-0.2	-0.7
8	N	0.0	0.0	0.0	0.0	-0.3	9.7	0.0	0.0
	MX	0.0	0.0	0.0	0.0	0.0	0.0	0.0	0.0
	QU	0.0	0.0	0.0	0.0	0.0	0.0	0.0	0.0
	MU	0.1	0.1	0.2	0.1	0.1	-0.1	0.0	0.2
	QX	-0.1	-0.1	-0.1	-0.1	-0.1	0.0	0.0	-0.1
9	N	0.0	0.0	0.0	0.0	-12.6	0.5	0.0	0.0
	MX	0.0	-0.1	-0.1	-0.1	0.2	-0.3	0.0	-0.8
	QU	-0.1	-0.1	-0.1	-0.1	0.2	-0.1	-0.1	-0.3
	MU	0.0	0.0	-0.1	0.0	0.0	0.0	0.0	0.0
	QX	0.0	0.0	0.0	0.0	0.0	0.0	0.0	0.0
14	N	-74.3	-102.2	-101.5	-134.0	-27.1	-54.2	-44.1	-84.7
	MX	0.6	-0.3	1.4	-0.5	-0.5	-1.0	0.0	-3.0
	QU	0.3	-0.2	0.8	-0.3	-0.3	-0.5	0.0	-1.3
	MU	-0.9	1.7	0.1	0.1	-0.1	1.3	0.0	-0.1
	QX	-0.5	1.0	0.1	0.0	0.0	0.5	0.0	0.0

ЛИСТ
3

1.220.1-3М.0-1.4 24МУЗ

ФОРМАТ А4

Номер загрузки	Тип усилки	Номер группы элементов							
		1	2	3	4	5	6	7	8
ЯРУС 4 СЕЧЕНИЕ 1									
1	N	0.0	0.0	0.0	0.0	-0.7	-0.7	0.0	0.0
	MX	-0.7	0.4	0.9	0.6	0.0	-0.1	0.0	-0.4
	QU	-0.3	-0.2	-0.3	-0.2	0.0	0.1	0.0	0.1
	MU	0.8	1.1	0.7	0.9	0.1	-0.1	0.0	-0.4
	QX	-0.3	-0.4	-0.2	-0.3	-0.1	0.0	0.0	-0.1
8	N	0.0	0.0	0.0	0.0	-0.2	-5.7	0.0	0.0
	MX	0.0	0.0	0.0	0.0	0.0	0.0	0.0	0.0
	QU	0.0	0.0	0.0	0.0	0.0	0.0	0.0	0.0
	MU	-0.1	-0.1	-0.2	-0.1	-0.1	-0.4	0.0	-0.2
	QX	0.0	0.0	-0.1	0.0	0.0	-0.2	0.0	-0.1
9	N	0.0	0.0	0.0	0.0	6.4	0.0	0.0	0.0
	MX	0.0	0.1	0.1	0.1	0.2	1.0	0.0	0.8
	QU	0.0	0.0	0.0	0.0	-0.1	-0.6	0.0	-0.5
	MU	0.0	0.0	0.1	0.0	0.0	0.1	0.0	0.0
	QX	0.0	0.0	0.0	0.0	0.0	0.1	0.0	0.0
14	N	49.4	66.8	66.1	85.7	12.7	65.8	0.0	53.6
	MX	0.8	-0.3	1.6	-0.6	-0.7	1.9	0.0	1.1
	QU	-0.5	0.2	-1.0	0.3	0.5	-1.3	0.0	-1.2
	MU	0.9	-1.6	-0.1	-0.1	0.1	-1.5	0.0	0.1
	QX	-0.5	0.8	-0.1	0.0	0.0	-0.5	0.0	0.0
ЯРУС 4 СЕЧЕНИЕ 2									
1	N	0.0	0.0	0.0	0.0	0.7	0.7	0.0	0.0
	MX	-0.2	-0.1	0.2	0.1	0.0	-0.1	0.0	0.2
	QU	-0.2	-0.1	0.3	0.2	0.0	-0.1	0.0	-0.1
	MU	0.1	-0.2	0.1	-0.2	0.1	0.0	0.0	0.0
	QX	-0.2	-0.3	-0.1	-0.2	0.1	0.0	0.0	0.1
8	N	0.0	0.0	0.0	0.0	0.2	5.7	0.0	0.0
	MX	0.0	0.0	0.0	0.0	0.0	0.0	0.0	0.0
	QU	0.0	0.0	0.0	0.0	0.0	0.0	0.0	0.0
	MU	0.0	0.0	-0.1	0.0	-0.1	-0.2	0.0	-0.1
	QX	0.0	0.0	0.1	0.0	0.0	0.2	0.0	0.1
9	N	0.0	0.0	0.0	0.0	-6.4	0.0	0.0	0.0
	MX	0.0	0.0	0.0	0.0	0.2	0.9	0.0	1.0
	QU	0.0	0.0	0.0	0.0	0.1	0.6	0.0	0.5
	MU	0.0	0.0	0.0	0.0	0.0	0.1	0.0	0.0
	QX	0.0	0.0	0.0	0.0	0.0	-0.1	0.0	0.0
14	N	-49.4	-66.8	-66.1	-85.7	-12.7	-65.8	0.0	-53.6
	MX	0.9	-0.3	1.6	-1.7	-0.8	2.5	0.0	2.9
	QU	0.5	-0.2	1.0	-0.7	-0.5	1.3	0.0	1.2
	MU	0.7	-1.1	0.1	-0.1	0.1	0.6	0.0	0.1
	QX	0.5	-0.8	0.1	0.0	0.0	-0.5	0.0	0.0

ЛИСТ
4

1.220.1-3М.0-1.4 24МУЗ

23171-04 87

ФОРМАТ А4

Безупола
Beff-
ОПЕРАТОР СИСТЕМЫ
САПР
КиевНИИЭП

ИНВ № ПОДЛ
ПОДПИСЬ И ДАТА
ВЗЯМ ИНВ №

Номер загрузки	Тип усилки	Номер группы элементов								
		1	2	3	4	5	6	7	8	
ЯРУС 1 СЕЧЕНИЕ 1										
1	N	0.0	0.0	0.0	0.0	-19.5	-16.1	0.0	0.0	
	MX	4.7	4.2	8.1	7.1	-21.2	10.3	-2.3	-5.5	
	MY	-1.0	-0.9	-1.7	-1.4	10.5	-2.8	0.5	1.1	
	QX	6.4	11.2	8.0	13.2	-17.0	16.0	-4.6	-4.7	
8	N	0.0	0.0	0.0	0.0	-0.7	-32.4	0.0	0.0	
	MX	0.0	0.0	0.0	0.1	-0.2	0.0	0.0	0.0	
	MY	0.0	0.0	0.0	0.0	0.1	0.0	0.0	0.0	
	QX	-0.7	-1.1	-1.2	-1.9	-2.4	-9.6	-1.1	-1.1	
9	N	0.0	0.0	0.0	0.0	-54.5	3.0	0.0	0.0	
	MX	1.4	2.5	2.4	4.0	20.5	4.7	2.2	2.2	
	MY	-0.3	-0.5	-0.5	-0.8	-10.2	-1.0	-0.4	-0.4	
	QX	-0.1	0.1	-0.2	-0.2	0.2	-1.0	0.1	0.2	
14	N	129.5	174.1	172.7	223.8	166.9	169.1	126.5	148.5	
	MX	0.9	-0.3	1.7	-0.6	4.9	1.7	0.0	-0.8	
	MY	-0.6	0.2	-1.2	0.4	-3.5	-1.1	0.0	0.7	
	QX	-1.2	1.9	-0.1	0.1	0.0	5.6	0.0	0.0	
1	N	0.0	0.0	0.0	0.0	19.5	16.1	0.0	0.0	
	MX	-0.5	-0.8	-1.5	-1.6	-20.9	0.9	0.4	1.0	
	MY	1.0	0.9	1.7	1.4	-10.5	2.8	-0.5	-1.1	
	QX	0.7	-2.1	-1.5	-3.1	1.3	16.2	0.9	0.9	
8	N	0.0	0.0	0.0	0.0	0.7	32.4	0.0	0.0	
	MX	0.0	0.0	0.0	0.0	-0.2	0.0	0.0	0.0	
	MY	0.0	0.0	0.0	0.0	-0.1	0.0	0.0	0.0	
	QX	0.1	0.2	0.2	0.5	0.3	-10.0	0.2	0.2	
9	N	0.0	0.0	0.0	0.0	54.5	-3.0	0.0	0.0	
	MX	-0.2	-0.6	-0.5	-1.0	20.5	-0.7	-0.5	-0.4	
	MY	0.3	0.5	0.5	0.8	10.2	1.0	0.4	0.4	
	QX	0.0	0.0	0.0	0.0	0.0	-1.0	0.0	0.0	
14	N	-129.5	-174.1	-172.7	-223.8	-166.9	-169.1	-126.5	-148.5	
	MX	1.4	-0.5	3.3	-1.0	9.0	2.8	0.0	-2.1	
	MY	0.6	-0.2	1.2	-0.4	3.5	1.1	0.0	-0.7	
	QX	1.9	-3.2	0.0	0.0	0.0	10.1	0.0	0.0	
1.220.1-3М.0-1.4 24МУ4										
ТИП	Егузов				СТАДИЯ	ЛИСТ	ЛИСТОВ			
И.КОНТР	Бойко				Р	1	4			
РУКЛР.	Рудавин				ЗДАНИЕ					
ПРОВЕРИЛ	Футорман				4Т 4.7.30-ЗАЛ(12)40-4.0					
РАЗРАБ	Зуенко				КиевЗНИИЭП					

Номер загрузки	Тип усилки	Номер группы элементов								
		1	2	3	4	5	6	7	8	
ЯРУС 2 СЕЧЕНИЕ 1										
1	N	0.0	0.0	0.0	0.0	3.0	2.8	0.0	0.0	
	MX	-0.5	0.8	1.5	1.6	0.4	0.9	-0.4	-1.0	
	MY	-1.0	-0.9	-1.7	-1.4	-0.3	-1.3	0.5	1.1	
	QX	-1.0	2.1	1.5	3.1	-1.6	-0.2	-0.9	-0.9	
8	N	0.0	0.0	0.0	0.0	-0.4	-13.7	0.0	0.0	
	MX	0.0	0.0	0.0	0.0	0.0	0.0	0.0	0.0	
	MY	0.0	0.0	0.0	0.0	0.0	0.0	0.0	0.0	
	QX	-0.1	-0.2	-0.2	-0.4	-0.2	-0.4	-0.2	-0.2	
9	N	0.0	0.0	0.0	0.0	19.1	1.0	0.0	0.0	
	MX	0.2	0.6	0.5	1.0	0.4	0.5	0.5	0.1	
	MY	-0.3	-0.5	-0.5	-0.8	-0.3	-0.5	-0.4	-0.4	
	QX	0.0	0.0	0.0	0.0	0.0	0.0	0.0	0.0	
14	N	99.2	137.5	136.8	182.4	70.0	71.1	88.2	115.7	
	MX	0.7	-0.2	1.4	-0.4	1.0	0.6	0.0	-1.1	
	MY	-0.6	0.2	-1.2	0.4	-0.5	-0.4	0.0	0.7	
	QX	-0.9	1.3	0.0	0.0	0.0	1.1	0.0	0.0	
ЯРУС 2 СЕЧЕНИЕ 2										
1	N	0.0	0.0	0.0	0.0	-3.0	-2.8	0.0	0.0	
	MX	2.0	1.2	2.4	1.6	0.3	2.2	-0.7	-1.7	
	MY	1.0	0.9	1.7	1.4	0.3	1.3	-0.5	-1.1	
	QX	2.7	3.3	2.3	3.0	-2.7	-0.2	-1.3	-1.4	
8	N	0.0	0.0	0.0	0.0	0.4	13.7	0.0	0.0	
	MX	0.0	0.0	0.0	0.0	0.0	0.0	0.0	0.0	
	MY	0.0	0.0	0.0	0.0	0.0	0.0	0.0	0.0	
	QX	-0.2	-0.3	-0.3	-0.4	-0.3	-0.3	-0.3	-0.3	
9	N	0.0	0.0	0.0	0.0	-19.1	-1.0	0.0	0.0	
	MX	0.4	0.6	0.6	0.8	0.3	0.6	0.5	0.7	
	MY	0.3	0.5	0.5	0.8	0.3	0.5	0.4	0.4	
	QX	0.0	0.0	-0.1	0.0	0.0	0.0	0.0	0.0	
14	N	-99.2	-137.5	-136.8	-182.4	-70.0	-71.1	-88.2	-115.7	
	MX	0.7	-0.3	1.6	-0.6	0.3	0.4	0.0	-0.6	
	MY	0.6	-0.2	1.2	-0.4	0.5	0.4	0.0	-0.7	
	QX	-0.9	1.7	-0.1	0.0	0.0	0.4	0.0	0.0	
1.220.1-3М.0-1.4 24МУ4										
ТИП	Егузов				СТАДИЯ	ЛИСТ	ЛИСТОВ			
И.КОНТР	Бойко				Р	1	4			
РУКЛР.	Рудавин				ЗДАНИЕ					
ПРОВЕРИЛ	Футорман				4Т 4.7.30-ЗАЛ(12)40-4.0					
РАЗРАБ	Зуенко				КиевЗНИИЭП					

Номер загруженная	Тип усилия	Номер группы элементов							
		1	2	3	4	5	6	7	8
ЯРУС 3 СЕЧЕНИЕ 1									
1	N	0.0	0.0	0.0	0.0	1.8	1.5	0.0	0.0
	MX	-2.0	-1.2	-2.4	-1.6	0.1	-2.0	0.7	1.7
	MY	0.7	0.5	0.9	0.6	-0.1	0.8	-0.2	-0.6
8	QX	-2.7	-3.3	-2.3	-3.0	2.0	-0.1	1.3	1.4
	QY	1.0	1.2	0.8	1.1	-0.5	0.0	0.1	0.5
	QZ	0.0	0.0	0.0	0.0	0.3	-9.6	0.0	0.0
9	N	0.0	0.0	0.0	0.0	0.0	0.0	0.0	0.0
	MX	0.0	0.0	0.0	0.0	0.0	0.0	0.0	0.0
	MY	0.2	0.3	0.3	0.4	0.3	-0.2	0.3	0.3
14	QX	0.1	0.1	0.2	0.2	0.1	0.0	0.1	0.2
	N	0.0	0.0	0.0	0.0	12.5	-0.5	0.0	0.0
	MX	-0.4	-0.6	-0.6	-0.8	0.3	-0.5	-0.5	-0.7
8	MY	0.2	0.2	0.2	0.3	-0.2	0.3	0.2	0.4
	QX	0.0	0.0	0.1	0.0	0.0	0.0	0.0	0.0
	QY	0.0	0.0	0.0	0.0	0.0	0.0	0.0	0.0
14	N	74.3	102.2	101.5	134.0	29.2	53.9	44.1	84.7
	MX	0.7	-0.3	1.4	-0.5	0.3	-0.6	0.0	-1.3
	MY	-0.4	0.2	-0.9	0.3	-0.2	0.5	0.0	1.3
8	QX	1.0	-1.7	0.1	0.0	0.0	0.8	0.0	0.0
	QY	0.6	-1.1	-0.1	0.0	0.0	-0.5	0.0	0.0
	ЯРУС 3 СЕЧЕНИЕ 2								
1	N	0.0	0.0	0.0	0.0	-1.8	-1.5	0.0	0.0
	MX	-0.4	-0.3	-0.6	-0.4	0.1	-0.8	0.0	0.3
	MY	-0.7	-0.5	-0.9	-0.6	0.1	-0.8	0.2	0.6
8	QX	-0.5	-0.7	-0.5	-0.7	0.7	-0.1	0.0	0.3
	QY	-1.0	-1.2	-0.8	-1.1	0.5	0.0	-0.1	-0.5
	N	0.0	0.0	0.0	0.0	-0.3	9.6	0.0	0.0
9	MX	0.0	0.0	0.0	0.0	0.0	0.0	0.0	0.0
	MY	0.0	0.0	0.0	0.0	0.0	0.0	0.0	0.0
	QX	0.1	0.1	0.2	0.2	0.2	-0.1	0.0	-0.2
14	QY	-0.1	-0.1	-0.2	-0.2	-0.1	0.0	-0.1	-0.2
	N	0.0	0.0	0.0	0.0	-12.5	0.5	0.0	0.0
	MX	-0.1	-0.1	-0.2	-0.2	0.2	-0.4	0.0	-0.8
8	MY	-0.1	-0.2	-0.2	-0.3	0.2	-0.3	-0.1	-0.4
	QX	0.0	0.0	-0.1	0.0	0.0	0.0	0.0	0.0
	QY	0.0	0.0	0.0	0.0	0.0	0.0	0.0	0.0
14	N	-74.3	-102.2	-101.5	-134.0	-29.2	-53.9	-44.1	-84.7
	MX	0.6	-0.3	1.4	-0.5	-0.5	-1.1	0.0	-3.0
	MY	0.4	-0.2	0.9	-0.3	-0.2	-0.5	0.0	-1.3
8	QX	-0.9	1.8	0.1	0.1	-0.1	1.3	0.0	-0.1
	QY	-0.6	1.1	0.1	0.0	0.0	0.5	0.0	0.0

1.220.1-3М.0-1.4 24МУ4

ЛИСТ
3

Номер загруженная	Тип усилия	Номер группы элементов							
		1	2	3	4	5	6	7	8
ЯРУС 4 СЕЧЕНИЕ 1									
1	N	0.0	0.0	0.0	0.0	0.3	0.2	0.0	0.0
	MX	-0.4	0.3	0.6	0.4	0.0	-0.1	0.0	-0.3
	MY	-0.2	-0.1	-0.2	-0.1	0.0	0.0	0.0	0.0
8	QX	-0.5	0.7	0.5	0.7	0.0	0.0	0.0	-0.3
	QY	-0.2	-0.3	-0.2	-0.2	0.0	0.0	0.0	-0.1
	N	0.0	0.0	0.0	0.0	0.2	-5.7	0.0	0.0
9	MX	0.0	0.0	0.0	0.0	0.0	0.0	0.0	0.0
	MY	0.0	0.0	0.0	0.0	0.0	0.0	0.0	0.0
	QX	-0.1	-0.1	-0.2	-0.2	-0.1	-0.4	0.0	-0.2
14	QY	0.0	0.0	-0.1	-0.1	0.0	-0.2	0.0	-0.1
	N	0.0	0.0	0.0	0.0	6.3	0.0	0.0	0.0
	MX	0.1	0.1	0.2	0.2	0.2	1.0	0.0	0.8
8	MY	0.0	0.0	0.0	-0.1	-0.1	-0.6	0.0	-0.5
	QX	0.0	0.0	0.1	0.0	0.0	0.2	0.0	0.0
	QY	0.0	0.0	0.0	0.0	0.0	0.1	0.0	0.0
14	N	49.4	66.8	66.1	85.7	13.1	65.8	0.0	53.6
	MX	0.7	-0.3	1.5	-0.6	-0.7	1.9	0.0	1.1
	MY	-0.5	0.2	-0.9	0.3	0.4	-1.3	0.0	-1.2
8	QX	0.9	-1.6	-0.1	-0.1	0.1	-1.5	0.0	0.1
	QY	-0.4	0.8	-0.1	0.0	0.1	-0.5	0.0	0.1
	ЯРУС 4 СЕЧЕНИЕ 2								
1	N	0.0	0.0	0.0	0.0	-0.3	-0.2	0.0	0.0
	MX	-0.1	-0.1	0.1	0.1	0.0	0.0	0.0	0.1
	MY	-0.2	-0.1	0.2	0.1	0.0	0.0	0.0	0.0
8	QX	-0.1	-0.1	0.1	-0.1	0.0	0.0	0.0	0.0
	QY	-0.2	-0.2	-0.1	0.2	0.0	0.0	0.0	0.1
	N	0.0	0.0	0.0	0.0	-0.2	5.7	0.0	0.0
9	MX	0.0	0.0	0.0	0.0	0.0	0.0	0.0	0.0
	MY	0.0	0.0	0.0	0.0	0.0	0.0	0.0	0.0
	QX	0.0	0.1	-0.1	0.0	0.0	-0.2	0.0	-0.1
14	QY	0.0	0.1	0.1	0.1	0.0	0.2	0.0	0.1
	N	0.0	0.0	0.0	0.0	-6.3	0.0	0.0	0.0
	MX	0.0	0.0	0.0	0.0	0.2	0.9	0.0	1.0
8	MY	0.0	0.0	0.0	0.0	0.1	0.6	0.0	0.5
	QX	0.0	0.0	0.0	0.0	0.0	0.1	0.0	0.0
	QY	0.0	0.0	0.0	0.0	0.0	-0.1	0.0	0.0
14	N	-49.4	-66.8	-66.1	-85.7	-13.1	-65.8	0.0	-53.6
	MX	0.9	-0.3	1.6	-1.7	-0.8	2.5	0.0	2.9
	MY	0.5	-0.2	0.9	-0.7	-0.4	1.3	0.0	1.2
8	QX	0.7	-1.1	0.1	-0.1	0.1	0.6	0.0	0.1
	QY	0.4	-0.8	0.1	0.0	-0.1	-0.5	0.0	-0.1

1.220.1-3М.0-1.4 24МУ4

ЛИСТ
4

МАРКА ПОЗ	ОБОЗНАЧЕНИЕ	НАИМЕНОВАНИЕ	КОП	МАССА ЕД КГ	ПРИМЕЧАНИЕ
		ДОКУМЕНТАЦИЯ			
A3	I.220.I-3M.0-I.4 00TO	ТЕХНИЧЕСКОЕ ОПИСАНИЕ СБОРОЧНЫЕ ЕДИНИЦЫ РИГЕЛЬ			
PI	I.220.I-3M.3-I 03-02	РДП4.53-50	7	2518	
P2	I.220.I-3M.3-I 01-01	РДП4.53-90АТУ	15	2518	
P9	I.220.I-3M.3-I 09	Р4.57-20	24	1710	
PI0	I.020-I/83.3-I 07-01	РОП 4.57-30	7	2070	
PI3	I.04I.I-2.I.400-01 ПЕРЕМЕННЫЕ ДАННЫЕ	СВЯЗЕВАЯ ПЛИТА ПК56.I5-6АТИУС(АЛУ)Т-2 ДЛЯ ИСПОЛНЕНИЯ I.220.I-3M.0-I.4 25 3Т 4.5.30-ЗАЛ(24) 40-2.5	3	2600	
Φ1	I.220.I-3M.I-I 04-01	РОСТВЕРК 2Φ3-40	4	3625	
Φ2	I.220.I-3M.I-I 03-01	IΦ3-40	8	3755	
Φ3	I.220.I-3M.I-I 03-01	IΦ3-40	1	3755	
Φ4	I.220.I-3M.I-I 02-01	Φ2-40	9	2575	
Φ6		3ΦД7-40	3		
Φ12		IΦД9-40	1		
KI	I.220.I-3M.2-I 13-04	КОЛОННА КОЗТ 3.33-30.3	4	2428	
K2	I.220.I-3M.2-I 17-02	КОЗТ 3.33-40.7	2	2414	
K3	I.220.I-3M.2-I 17-02	КОЗТ 3.33-40.7	4	2414	
K4	I.220.I-3M.2-I 13-04	КОЗТ 3.33-30.2	2	2428	
K5	I.220.I-3M.2-I 15-08	КДМЗТ 3.33-40.7	2	2509	
K6	I.220.I-3M.2 I 13-04	КОЗТ 3.33-30.3	2	2428	
K7	I.220.I-3M.2-I 09	КДПТ 3.33-25.1	9	776	
I.220.I-3M.0-I.4 25					
ИМ.ОТД	Шевченко	ЗДАНИЕ 3Т 4.5-ЗАЛ(24) 4Т 4.5-ЗАЛ(24)	СТАДИЯ	ЛИСТ	ЛИСТОВ
И.КОМТР	Егучев		Р	1	4
ГЛ.СПЕЦ	Рудавка		ГОСГРАЖДАНСТРОЙ		
ПРОВЕРИЛ	Зуенко		КиевЗНИИЭП		
РАЗРАБ.	Безгудова				

МАРКА ПОЗ	ОБОЗНАЧЕНИЕ	НАИМЕНОВАНИЕ	КОП	МАССА ЕД КГ	ПРИМЕЧАНИЕ
K8	I.220.I-3M.2-I II-06	КДЗТ 3.33-40.7	1	2532	
K9	I.220.I-3M.2-I II-04	КДЗТ 3.33-30.3	3	2496	
K10	I.220.I-3M.2-I II-01	КДЗТ 3.33-25.3	1	2496	
		РИГЕЛЬ			
P3	I.020-I/83.3-I 07-02	РОП 4.57-40	14	2070	
P4	I.020-I/83.3-I 02-03	РДП 4.57-70АТУ	15	2600	
		СВЯЗЕВАЯ ПЛИТА			
PII	I.04I.I-2.I.200-01	ПК56.I2-8АТИУС(АЛУ)Т-1	12	2000	
PI2	I.04I.I-2.I.400-02	ПК56.I5-8АТИУС(АЛУ)Т-2 I.220.I-3M.0-I.4 25-01 3Т 4.5.30-ЗАЛ(24) 40-4.0	18	2600	
		РОСТВЕРК			
Φ1	I.220.I-3M.I-I 04-01	2Φ3-40	4	3625	
Φ2	I.220.I-3M.I-I 03-01	IΦ3-40	8	3755	
Φ3	I.220.I-3M.I-I 03-01	IΦ3-40	1	3755	
Φ4	I.220.I-3M.I-I	Φ2-40	9	2575	
Φ6		3ΦД7-40	3		
Φ12		IΦД9-40	1		
		КОЛОННА			
K1	I.220.I-3M.2-I 13-04	КОЗТ 3.33-30.3	4	2428	
K2	I.220.I-3M.2-I 17-02	КОЗТ 3.33-40.7	2	2414	
K3	I.220.I-3M.2-I 17-02	КОЗТ 3.33-40.7	4	2414	
K4	I.220.I-3M.2-I 13	КОЗТ 3.33-25.2	2	2373	
K5	I.220.I-3M.2-I 15-08	КДМЗТ 3.33-40.7	2	2509	
K6	I.220.I-3M.2-I 13-01	КОЗТ 3.33-25.3	2	2428	
K7	I.220.I-3M.2-I 09	КДПТ 3.33-25.1	9	776	
K8	I.220.I-3M.2-I II-06	КДЗТ 3.33-40.7	1	2532	
K9	I.220.I-3M.2-I II-01	КДЗТ 3.33-25.3	3	2496	
K10	I.220.I-3M.2-I II	КДЗТ 3.33-25.2	1	2441	
		РИГЕЛЬ			
P3	I.020-I/83.3-I 07-02	РОП 4.57-40	14	2070	
P4	I.020-I/83.3-I 02-03	РДП 4.57-70АТУ	15	2600	
I.220.I-3M.0-I.4 25					
ИМ.И.ПОДП	ПОДПИСЬ И ДАТА	ВЗЯТ ИМ.И.И			
					ЛИСТ 2

МАРКА ПОЗ.	ОБОЗНАЧЕНИЕ	НАИМЕНОВАНИЕ	КОП.	МАССА ЕД. КГ.	ПРИМЕЧАНИЕ
РП	I.04I.I-2.I	СВЯЗЕВАЯ ПЛИТА			
РП2	I.04I.I-2.I	ПК56.12-8АТ1УС(А1У)Т-1 ПК56.12-8АТ1УС(А1У)Т-2 I.220.I-3M.0-I.4 25-02 4Т.4.5.30-3АЛ(24) 32-3.5	12 18		
Ф1	I.220.I-3M.I-I 04	РОСТВЕРК	4	4275	
Ф2	I.220.I-3M.I-I 03	2Ф3-32	8	4390	
Ф3	I.220.I-3M.I-I 05	1Ф3-32	1	4775	
Ф4	I.220.I-3M.I-I 02	Ф4-32	9	2650	
Ф6		Ф2-32	3		
Ф12		ФД9-32	1		
		1ФД11-32			
		КОЛОННА			
К1	I.220.I-3M.2-I 18-02	КО4Т 3.33-40.3	4	3252	
К2	I.220.I-3M.2-I 24-03	КОФ4Т 3.33-40.7	2	3248	
К3	I.220.I-3M.2-I 24-03	КОФ4Т 3.33-40.7	4	3248	
К4	I.220.I-3M.2-I 18	КО4Т 3.33-30.2	2	3179	
К5	I.220.I-3M.2-I 21-06	КО4Т 3.33-40.7	2	3346	
К6	I.220.I-3M.2-I 18-02	КО4Т 3.33-40.3	2	3252	
К7	I.220.I-3M.2-I 10	КД2Т 3.33-25.1	9	1592	
К8	I.220.I-3M.2-I 18-07	КД4Т 3.33-40.7	1	3392	
К9	I.220.I-3M.2-I 18-01	КД4Т 3.33-40.2	3	3179	
К10	I.220.I-3M.2-I 18-03	КД4Т 3.33-30.2	1	3269	
		РИГЕЛЬ			
Р3	I.020-I/83.3-I 07-02	РОП 4.57-40	21	2070	
Р4	I.020-I/83.3-I 02-03	РДП 4.57-70АТУ	30	2600	
		СВЯЗЕВАЯ ПЛИТА			
РП	I.04I.I-2.I.200-01	ПК56.12-8АТ1УС(А1У)Т-1	20	2000	
РП2	I.04I.I-2.I.400-02	ПК56.15-8АТ1УС(А1У)Т-2 I.220.I-3M.0-I.4 25-03 4Т.4.5.30-3АЛ(24) 40-4.0	33	2600	
I.220.I-3M.0-I.4 25					Лист 3

МАРКА ПОЗ.	ОБОЗНАЧЕНИЕ	НАИМЕНОВАНИЕ	КОП.	МАССА ЕД. КГ.	ПРИМЕЧАНИЕ
Ф1	I.220.I-3M.I-I 04-01	РОСТВЕРК	4	3625	
Ф2	I.220.I-3M.I-I 03-01	2Ф3-40	8	3755	
Ф3	I.220.I-3M.I-I 05-01	1Ф3-40	1	4100	
Ф4	I.220.I-3M.I-I 02-01	Ф4-40	9	2575	
Ф6		Ф2-40	3		
Ф12		ФД9-40	1		
		1ФД11-40			
		КОЛОННА			
К1	I.220.I-3M.2-I 18-02	КО4Т 3.33-40.3	4	3252	
К2	I.220.I-3M.2-I 24-03	КОФ4Т 3.33-40.7	2	3248	
К3	I.220.I-3M.2-I 24-03	КОФ4Т 3.33-40.7	4	3248	
К4	I.220.I-3M.2-I 18	КО4Т 3.33-30.2	2	3179	
К5	I.220.I-3M.2-I 21 06	КО4Т 3.33-40.7	2	3346	
К6	I.220.I-3M.2-I 18	КО4Т 3.33-30.2	2	3179	
К7	I.220.I-3M.2-I 10	КД2Т 3.33-25.1	9	1592	
К8	I.220.I-3M.2-I 18-07	КД4Т 3.33-40.7	1	3392	
К9	I.220.I-3M.2-I 18-04	КД4Т 3.33-40.2	3	3269	
К10	I.220.I-3M.2-I 18-04	КД4Т 3.33-40.2	1	3269	
		РИГЕЛЬ			
Р3	I.020-I/83.3-I 07-02	РОП 4.57-40	21	2070	
Р4	I.020-I/83.3-I 02-03	РДП 4.57-70АТУ	30	2600	
		СВЯЗЕВАЯ ПЛИТА			
РП	I.04I.I-2.I.200-01	ПК56.12-8АТ1УС(А1У)Т-1	20	2000	
РП2	I.04I.I-2.I.400-02	ПК56.15-8АТ1УС(А1У)Т-2	33	2600	
I.220.I-3M.0-I.4 25					Лист 4

МОНТАЖНЫЙ ПЛАН РОСТВЕРКОВ

МОНТАЖНЫЙ ПЛАН КОЛОНН

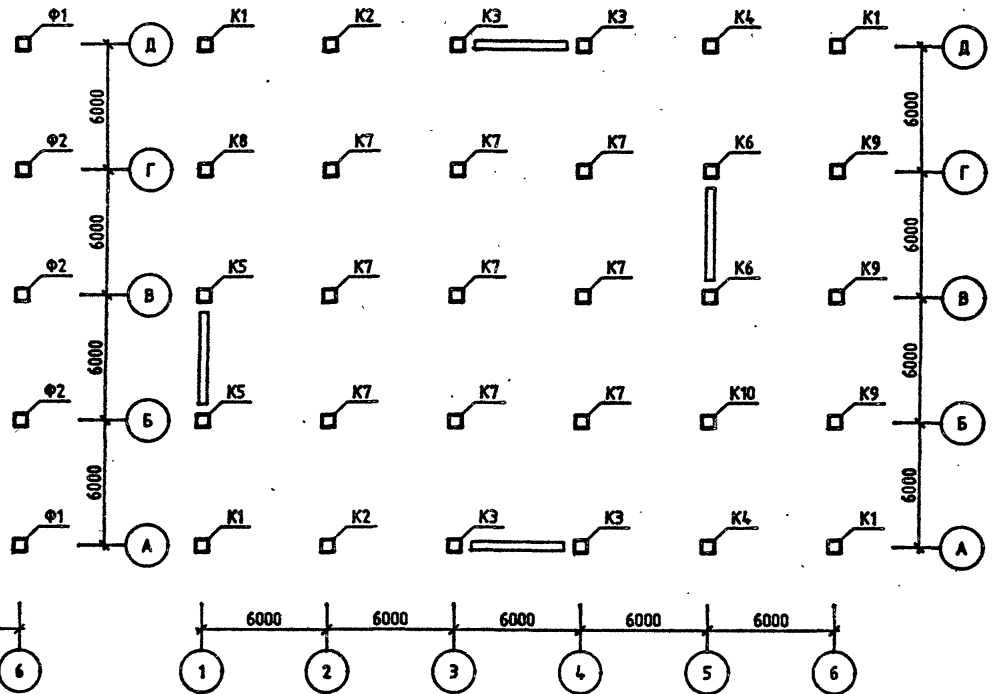
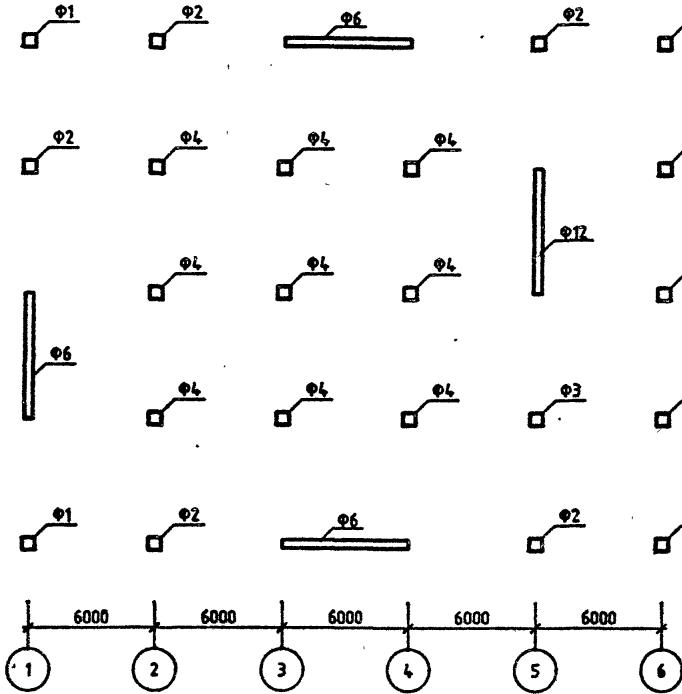

ОБОЗНАЧЕНИЕ	ШИФР ЗДАНИЯ
1220.1-ЭМ.0-1.4 25	ЭТ 4.5.30-ЗАЛ(24)40-2.5
-01	ЭТ 4.5.30-ЗАЛ(24)40-4.0
-02	4Т 4.5.30-ЗАЛ(24)40-2.5
-03	4Т 4.5.30-ЗАЛ(24)40-4.0

1.220.1-3М.0-1.4 25СБ			
ЗДАНИЕ ЭТ 4.5-ЗАЛ(24), 4Т 4.5-ЗАЛ(24)			
Исх. отд.	Шевченко	СТАДИЯ	ЛИСТ
ТИП	Бугаев	Р	1
И. КОМП.	Зуевко	ЛИСТОВ	3
ПРОЕКТИР.	Бойко	ГОСГРАЖДАНСТРОЙ	
РАЗРАБ.	Рудашен	КиевЗНИИЭП	

МОНТАЖНЫЙ ПЛАН РИГЕЛЕЙ

ОТМ. -2.32

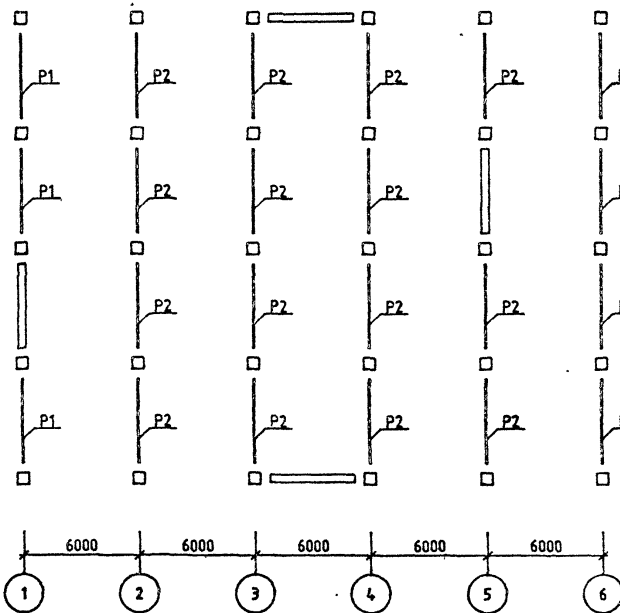

МОНТАЖНЫЙ ПЛАН РИГЕЛЕЙ И СВЯЗЕВЫХ ПЛИТ

ОТМ. -0.10 (+3.20)

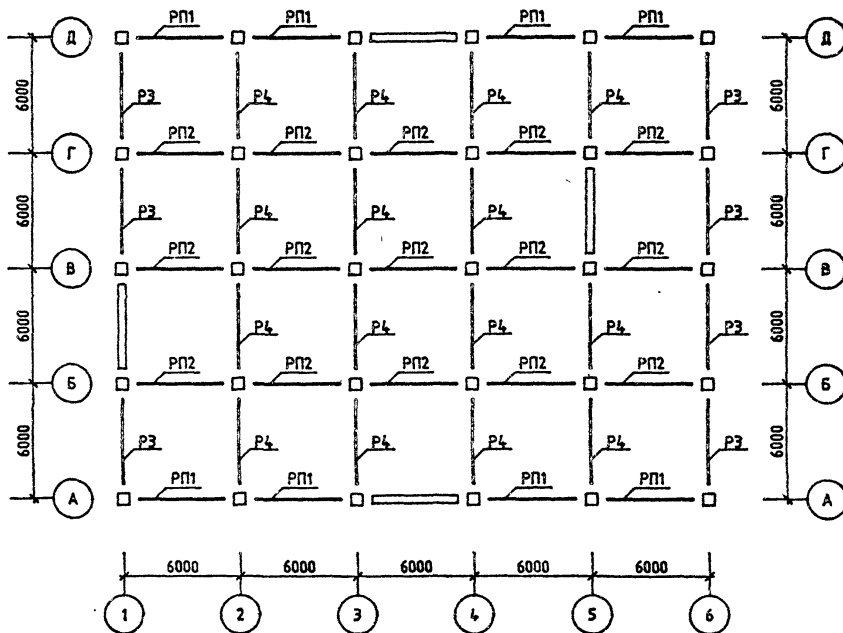

МОНТАЖНЫЙ ПЛАН РИГЕЛЕЙ И СВЯЗЕВЫХ ПЛИТ
 ОТМ. +3.20 (+6.50)

МОНТАЖНЫЙ ПЛАН РИГЕЛЕЙ И СВЯЗЕВЫХ ПЛИТ
 ОТМ. +6.50 (+9.80)

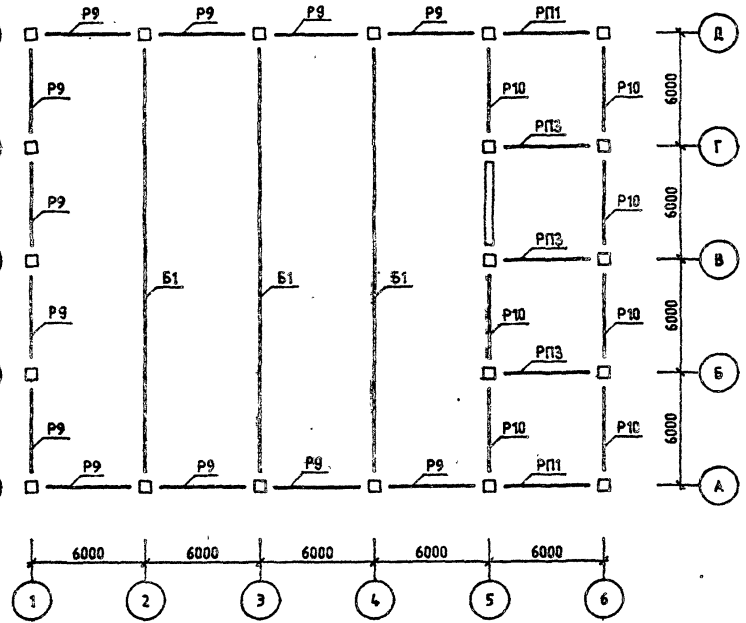
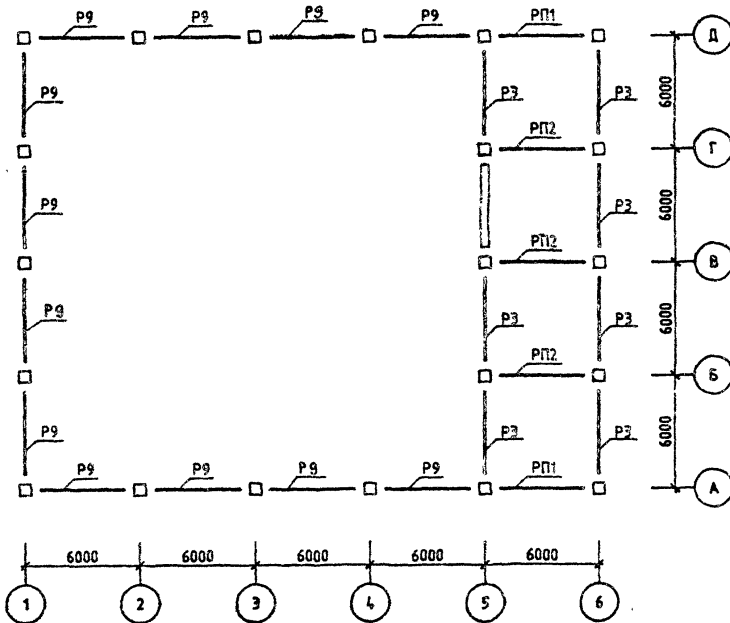

1.220.1-3М.0-1.4 2506

ЛИСТ

3

Номер загрузки	Тип усилки	Номер группы элементов							
		1	2	3	4	5	6	7	8
ЯРУС 1 СЕЧЕНИЕ 1									
1	N	0.0	0.0	0.0	0.0	-19.3	-12.7	0.0	0.0
	MX	-6.8	-6.3	-10.7	-8.8	44.6	-11.0	-3.7	8.6
	QU	1.9	1.7	2.9	2.3	-34.4	2.7	0.8	-2.1
	MU	8.2	-11.0	-6.9	-8.4	-14.6	22.5	5.1	8.4
	QX	-1.8	-2.7	-1.4	-2.1	-3.7	-8.0	-0.2	1.9
8	N	0.0	0.0	0.0	0.0	-0.3	18.0	0.0	0.0
	MX	0.1	0.1	-0.1	-0.1	-0.1	0.1	0.0	0.2
	QU	-0.1	-0.1	0.0	0.0	0.0	-0.1	0.0	-0.1
	MU	1.6	2.7	2.2	2.7	4.4	-8.1	-1.1	2.1
	QX	0.9	1.3	1.1	1.2	4.1	-6.0	-0.2	1.0
9	N	0.0	0.0	0.0	0.0	-27.6	-3.6	0.0	0.0
	MX	-1.8	-2.3	0.7	1.1	9.4	0.3	0.7	-2.5
	QU	0.9	1.1	-0.2	-0.3	-7.7	0.3	-0.1	1.1
	MU	-1.1	-0.7	-1.4	-1.0	1.1	-1.1	0.1	-1.6
	QX	-0.5	0.3	-0.6	-0.4	0.7	-0.7	0.0	-0.7
14	N	94.5	127.1	112.2	140.3	112.9	133.9	82.4	150.8
	MX	-0.6	0.1	0.6	0.1	-3.5	1.8	0.0	2.5
	QU	0.6	0.0	-1.1	0.0	3.8	-1.8	0.0	-1.8
	MU	-0.7	0.7	-0.3	-0.4	-0.7	0.0	0.1	0.1
	QX	-0.9	1.3	-0.1	-0.1	-0.2	-0.1	0.0	0.0
ЯРУС 1 СЕЧЕНИЕ 2									
1	N	0.0	0.0	0.0	0.0	19.3	12.7	0.0	0.0
	MX	1.9	2.1	3.5	3.1	41.5	4.3	1.8	-3.3
	QU	-1.9	-1.7	-2.9	-2.3	34.4	-2.7	-0.8	2.1
	MU	2.3	3.9	2.5	3.2	5.3	21.1	-2.5	-2.7
	QX	1.8	2.7	1.4	2.1	3.7	8.0	0.2	-1.9
8	N	0.0	0.0	0.0	0.0	0.3	-18.0	0.0	0.0
	MX	0.0	0.0	0.0	0.0	0.0	0.0	0.0	0.0
	QU	0.1	0.0	0.0	0.0	0.0	0.0	0.0	0.0
	MU	0.7	0.6	0.5	0.3	5.9	-7.5	0.5	0.5
	QX	-0.8	-1.0	-1.1	-1.2	-1.1	6.2	0.2	-1.0
9	N	0.0	0.0	0.0	0.0	27.6	3.6	0.0	0.0
	MX	-0.6	-0.4	-0.3	-0.4	9.7	-1.4	-0.3	-0.4
	QU	-0.9	-1.1	0.2	0.3	7.7	-0.6	0.1	-1.1
	MU	-0.3	0.0	-0.1	0.1	0.6	-0.9	0.0	0.1
	QX	-0.5	-0.3	0.6	0.4	-0.7	-0.8	0.0	-0.6
14	N	-94.5	-127.1	-112.2	-140.3	-112.9	-133.9	-82.4	-150.8
	MX	0.9	0.0	-2.1	0.0	-6.0	-2.7	0.0	-2.1
	QU	0.6	0.0	-1.1	0.0	-3.8	-1.8	0.0	-1.8
	MU	-1.5	2.6	0.0	0.1	-2.1	-0.4	0.0	0.0
	QX	0.9	-1.3	0.1	0.1	0.2	-0.1	0.0	0.0

1.220.1-3М.0-1.4 25МУ1

ГИП	Егунов	<i>[Signature]</i>
И КОНТР.	Бойко	<i>[Signature]</i>
РУК.ГР.	Рудавий	<i>[Signature]</i>
ПРОВЕРИЛ	Футорная	<i>[Signature]</i>
РАЗРАБ	Зуенко	<i>[Signature]</i>

ЗДАНИЕ
ЭТ 4.5.30-ЗАЛ(24)40-2.5

СТАДИЯ	ЛИСТ	ЛИСТОВ
Р	1	3
ГОСГРАЖДАНСТРОЙ		
КиевЗНИИЭП		

ФОРМАТ А4

Номер загрузки	Тип усилки	Номер группы элементов							
		1	2	3	4	5	6	7	8
ЯРУС 2 СЕЧЕНИЕ 1									
1	N	0.0	0.0	0.0	0.0	-9.6	-6.3	0.0	0.0
	MX	-1.9	-2.1	-3.5	-3.1	-0.5	-1.6	-1.8	3.3
	QU	1.9	1.7	2.9	2.3	0.3	1.2	0.8	-2.1
	MU	-2.3	-3.9	-2.5	-3.2	-1.9	0.4	2.5	2.7
	QX	-1.8	-2.7	-1.4	-2.1	-1.5	0.3	-0.2	1.9
8	N	0.0	0.0	0.0	0.0	-0.4	-6.6	0.0	0.0
	MX	0.0	0.0	0.0	0.0	0.0	0.0	0.0	0.0
	QU	-0.1	0.0	0.0	0.0	0.0	0.0	0.0	0.0
	MU	-0.7	-0.6	-0.5	-0.3	0.8	0.4	-0.5	-0.5
	QX	0.8	1.0	1.1	1.2	0.5	0.4	-0.2	1.0
9	N	0.0	0.0	0.0	0.0	-9.7	-3.1	0.0	0.0
	MX	0.6	0.4	0.3	0.4	-0.4	0.0	0.3	0.4
	QU	0.9	1.1	-0.2	-0.3	0.4	0.3	-0.1	1.1
	MU	0.3	0.0	0.1	-0.1	0.2	-0.2	0.0	-0.1
	QX	0.5	0.3	-0.6	-0.4	-0.2	-0.2	0.0	0.6
14	N	67.0	93.2	79.5	102.0	48.4	78.6	44.1	118.1
	MX	0.6	0.0	1.2	0.0	0.3	0.7	0.0	1.2
	QU	-0.4	0.0	-1.1	0.0	-0.5	-0.8	0.0	-1.8
	MU	1.0	-1.5	0.0	-0.1	-0.7	-0.3	0.0	0.0
	QX	0.8	1.3	-0.1	-0.1	-0.5	0.6	0.0	0.0
ЯРУС 2 СЕЧЕНИЕ 2									
1	N	0.0	0.0	0.0	0.0	9.6	6.3	0.0	0.0
	MX	-2.7	-1.9	-3.4	-2.3	-0.3	-1.2	0.0	-1.9
	QU	-1.9	-1.7	-2.9	-2.3	-0.3	-1.2	-0.8	-2.0
	MU	3.5	-2.9	-1.6	-1.7	-1.7	0.4	0.0	2.8
	QX	1.8	2.7	1.4	2.1	-1.4	-0.3	0.2	-2.3
8	N	0.0	0.0	0.0	0.0	0.4	6.6	0.0	0.0
	MX	0.2	0.2	-0.1	-0.1	0.0	0.0	0.0	0.2
	QU	0.1	0.1	0.0	0.0	0.0	0.0	0.0	0.1
	MU	2.9	3.6	3.0	3.1	4.1	0.5	0.0	2.9
	QX	-0.9	-1.3	-1.1	-1.2	-0.5	-0.4	0.2	-1.0
9	N	0.0	0.0	0.0	0.0	9.7	3.1	0.0	0.0
	MX	-2.9	-2.9	0.2	0.2	-0.5	-0.8	0.0	-3.1
	QU	-0.9	-1.1	0.2	0.3	-0.4	-0.3	0.1	-1.1
	MU	-1.5	-0.8	-1.5	-0.8	0.9	-0.2	0.0	-1.6
	QX	0.5	-0.3	0.6	0.4	0.2	0.2	0.0	0.7
14	N	-67.0	-93.2	-79.5	-102.0	-48.4	-78.6	-44.1	-118.1
	MX	-0.8	0.0	1.4	0.0	0.9	1.3	0.0	3.2
	QU	-0.6	0.0	1.1	0.0	0.5	0.8	0.0	1.8
	MU	-1.1	1.7	-0.2	-0.2	-0.5	-1.2	0.0	0.0
	QX	0.9	-1.3	0.1	0.1	0.5	0.6	0.0	0.0

Безудова
Без
ОПЕРАТОР СИСТЕМЫ
САПР
КиевЗНИИЭП
ИНВ № ПОДЛ
ПОДПИСЬ И ДАТА
ВЗАМ ИНВ №

1.220.1-3М.0-1.4 25МУ1		ЛИСТ 2
------------------------	--	-----------

23171-04 95

ФОРМАТ А4

Номер загрузки	Тип усилки	Номер группы элементов							
		1	2	3	4	5	6	7	8
ЯРУС 3 СЕЧЕНИЕ 1									
1	N	0.0	0.0	0.0	0.0	-3.2	0.1	0.0	0.0
	MX	2.7	1.9	3.4	2.3	0.8	1.8	0.0	1.9
	QU	1.0	-0.7	-1.3	-0.9	-0.3	-0.3	0.0	-0.3
	MU	3.5	2.9	1.6	1.7	-2.5	-1.5	0.0	-2.8
	QX	0.8	1.0	0.5	0.6	-0.4	-0.2	0.0	-1.0
8	N	0.0	0.0	0.0	0.0	0.2	0.8	0.0	0.0
	MX	-0.2	-0.2	0.1	0.1	-0.4	-0.1	0.0	-0.2
	QU	0.0	0.0	0.0	0.0	0.1	0.0	0.0	0.0
	MU	-2.9	-3.6	-3.0	-3.1	-5.0	-6.7	0.0	-2.9
	QX	-0.4	-1.0	-0.4	-0.5	-1.2	-1.9	0.0	-0.4
9	N	0.0	0.0	0.0	0.0	-5.5	-0.5	0.0	0.0
	MX	2.9	2.9	-0.2	-0.2	6.3	3.0	0.0	3.1
	QU	-0.3	-0.3	0.1	0.1	-1.6	-0.9	0.0	-0.9
	MU	1.5	0.8	1.5	0.8	1.1	3.1	0.0	1.6
	QX	0.2	-0.1	0.1	0.1	0.2	0.8	0.0	0.2
14	N	44.3	60.9	48.4	57.9	38.2	86.6	0.0	87.0
	MX	-0.4	0.0	-0.6	0.0	-0.8	-1.9	0.0	-1.2
	QU	0.3	0.0	0.1	0.0	-0.3	1.3	0.0	1.2
	MU	0.9	-2.2	0.2	0.2	-2.3	1.4	0.0	0.0
	QX	0.5	0.8	0.1	0.2	-1.4	-0.4	0.0	0.0
ЯРУС 3 СЕЧЕНИЕ 2									
1	N	0.0	0.0	0.0	0.0	3.2	-0.1	0.0	0.0
	MX	0.5	0.4	0.8	0.5	0.2	-0.9	0.0	-0.9
	QU	0.9	0.7	1.3	0.9	0.3	0.3	0.0	0.3
	MU	-0.7	1.3	0.2	0.1	1.2	-0.4	0.0	-0.6
	QX	1.3	-1.0	-0.5	-0.6	0.4	0.2	0.0	1.0
8	N	0.0	0.0	0.0	0.0	-0.2	-0.8	0.0	0.0
	MX	0.1	0.1	0.1	0.1	0.1	0.1	0.0	0.1
	QU	0.0	0.0	0.0	0.0	-0.1	0.0	0.0	0.0
	MU	1.7	1.4	1.5	1.4	1.1	0.5	0.0	1.6
	QX	0.4	1.0	0.4	0.5	1.2	1.9	0.0	0.4
9	N	0.0	0.0	0.0	0.0	5.5	0.5	0.0	0.0
	MX	-1.9	-1.9	-0.1	-0.1	-0.9	0.4	0.0	-0.4
	QU	0.3	0.3	-0.1	-0.1	1.6	0.7	0.0	0.8
	MU	-1.1	-0.5	-1.0	-0.5	-0.6	-0.6	0.0	-1.0
	QX	0.1	0.1	-0.1	-0.1	0.0	-0.7	0.0	0.2
14	N	-44.3	-60.9	-48.4	-57.9	-38.2	-86.6	0.0	-87.0
	MX	0.9	0.0	-0.1	0.0	0.5	2.5	0.0	2.8
	QU	0.3	0.0	0.1	0.0	0.3	1.3	0.0	1.2
	MU	0.8	-2.4	0.2	0.3	-2.3	0.5	0.0	0.0
	QX	0.4	-0.8	-0.1	-0.2	-0.2	0.4	0.0	0.0
1.220.1-3М.0-1.4 25МУ1									ЛИСТ 3

ФОРМАТ А4

Номер загрузки	Тип усилки	Номер группы элементов										
		1	2	3	4	5	6	7	8			
ЯРУС 1 СЕЧЕНИЕ 1												
1	N	0.0	0.0	0.0	0.0	-21.7	-17.5	0.0	0.0			
	MX	-4.3	-4.2	-7.2	-6.7	22.6	-6.6	-2.6	6.1			
	QU	0.9	0.8	1.5	1.3	-11.2	1.3	0.4	-1.1			
	MU	5.2	-7.7	-4.8	-6.6	-9.7	11.4	3.8	5.8			
	QX	-0.8	-1.4	-0.7	-1.2	-2.0	-2.6	-0.1	1.0			
8	N	0.0	0.0	0.0	0.0	-0.2	17.9	0.0	0.0			
	MX	0.1	0.1	-0.1	-0.1	-0.1	0.1	0.0	0.2			
	QU	0.0	0.0	0.0	0.0	0.1	0.0	0.0	0.0			
	MU	0.7	1.3	0.7	0.4	3.1	-10.8	-2.0	0.6			
	QX	0.5	0.7	0.5	0.5	2.9	-5.1	-0.3	0.5			
9	N	0.0	0.0	0.0	0.0	-30.1	-2.9	0.0	0.0			
	MX	1.4	2.3	1.7	2.9	14.5	1.0	1.5	-1.1			
	QU	-0.4	-0.5	-0.3	-0.6	-7.2	0.1	-0.2	0.6			
	MU	-0.9	-0.6	-1.2	-0.9	1.0	-1.0	-0.1	-1.3			
	QX	-0.3	-0.2	0.4	-0.3	0.5	-0.4	0.0	-0.4			
14	N	94.5	127.1	112.2	140.3	124.4	126.3	82.4	150.8			
	MX	-0.8	0.0	1.4	0.1	-2.8	2.5	0.0	3.0			
	QU	0.5	0.0	-0.9	0.0	2.0	-1.5	0.0	-1.4			
	MU	-1.1	1.7	-0.2	-0.3	-1.4	0.0	0.0	0.1			
	QX	-0.7	1.1	-0.1	-0.1	-0.1	0.0	0.0	0.0			
ЯРУС 1 СЕЧЕНИЕ 2												
1	N	0.0	0.0	0.0	0.0	21.7	17.5	0.0	0.0			
	MX	-0.5	0.8	1.3	1.5	22.2	1.6	1.0	-1.5			
	QU	0.9	-0.8	-1.5	-1.3	11.2	-1.2	-0.4	1.1			
	MU	0.7	1.7	1.1	1.7	-1.9	11.5	-1.4	-1.0			
	QX	-1.1	1.4	0.7	1.2	2.0	-5.7	0.1	-1.0			
8	N	0.0	0.0	0.0	0.0	0.2	-17.9	0.0	0.0			
	MX	0.1	0.0	0.0	0.0	-0.1	0.1	0.0	0.0			
	QU	0.0	0.0	0.0	0.0	-0.1	0.0	0.0	0.0			
	MU	1.4	1.6	1.4	1.5	8.5	-10.0	0.8	1.4			
	QX	-0.5	-0.7	-0.5	-0.5	-2.9	5.1	0.3	-0.5			
9	N	0.0	0.0	0.0	0.0	30.1	2.9	0.0	0.0			
	MX	-1.2	-1.2	-0.4	-0.7	14.1	-1.8	-0.6	-1.3			
	QU	-0.5	-0.5	0.3	0.6	7.2	-0.3	0.2	-0.6			
	MU	-0.5	-0.2	-0.4	-0.2	0.9	-0.8	0.0	-0.4			
	QX	-0.3	-0.2	0.4	0.3	-0.5	-0.4	0.0	0.4			
14	N	-94.5	-127.1	-112.2	-140.3	-124.4	-126.3	-82.4	-150.8			
	MX	-1.0	0.0	2.3	0.0	-5.0	-3.4	0.0	-2.8			
	QU	-0.5	0.0	0.9	0.0	-2.0	-1.5	0.0	-1.4			
	MU	-1.7	2.9	0.0	0.0	-2.4	-0.2	0.0	0.0			
	QX	0.7	-1.1	0.1	0.1	0.1	0.0	0.0	0.0			
1.220.1-3М.0-1.4 25МУ2												
ИМЯ ГОДА	ГИП	Егулов								СТАДИЯ	ЛИСТ	ЛИСТОВ
	Н.КОНТР.	Бойко								Р	1	3
	РУК.ГР.	Рудавки								ГОСГРАЖДАНСТРОЙ		
	ПРОВЕРИЛ	Футормая								КиевЗНИИЭП		
РАЗРАБ	Зуенко								ЗДАНИЕ 3Т 4.5.30-ЗАЛ(24)40-4.0			

23171-04 96

ФОРМАТ А4

Номер загрузки	Тип усилия	Номер группы элементов							
		1	2	3	4	5	6	7	8
ЯРУС 2 СЕЧЕНИЕ 1									
1	N	0.0	0.0	0.0	0.0	2.7	1.4	0.0	0.0
	MX	0.5	-0.8	-1.3	-1.5	-0.4	-0.7	-1.0	1.5
	QY	-0.9	0.8	1.5	1.3	0.3	0.6	0.4	-1.1
	MU	-0.7	-1.7	-1.1	-1.7	-0.9	0.2	1.4	1.0
	QX	1.1	-1.4	-0.7	-1.2	-0.9	0.0	-0.1	1.0
8	N	0.0	0.0	0.0	0.0	-0.4	-5.3	0.0	0.0
	MX	-0.1	0.0	0.0	0.0	0.0	0.0	0.0	0.0
	QY	0.0	0.0	0.0	0.0	0.0	0.0	0.0	0.0
	MU	-1.4	-1.6	-1.4	-1.5	-0.2	0.8	-0.8	-1.4
	QX	0.5	0.7	0.5	0.5	0.4	0.7	-0.3	0.5
9	N	0.0	0.0	0.0	0.0	-7.8	-3.0	0.0	0.0
	MX	1.2	1.2	0.4	0.7	-0.7	0.2	0.6	1.3
	QY	0.5	0.5	-0.3	-0.6	0.6	0.2	-0.2	0.6
	MU	0.5	0.2	0.4	0.2	0.1	-0.2	0.0	0.4
	QX	0.3	0.2	-0.4	-0.3	-0.2	0.2	0.0	-0.4
14	N	67.0	93.2	79.5	102.0	47.7	77.7	44.1	118.1
	MX	-0.5	0.0	-0.9	0.0	0.4	0.5	0.0	0.5
	QY	0.4	0.0	0.9	0.0	-0.1	-0.7	0.0	-1.4
	MU	0.8	-1.4	0.0	0.0	-0.6	-0.4	0.0	0.0
	QX	0.7	1.1	-0.1	-0.1	-0.1	0.7	0.0	0.0
ЯРУС 2 СЕЧЕНИЕ 2									
1	N	0.0	0.0	0.0	0.0	-2.7	-1.4	0.0	0.0
	MX	-1.7	-1.2	-2.2	-1.5	-0.3	-0.7	0.0	-1.3
	QY	-0.9	-0.8	-1.5	-1.3	-0.3	-0.6	-0.4	-1.1
	MU	2.3	-1.9	-1.0	-1.2	-1.1	0.2	0.0	1.9
	QX	0.8	1.4	0.7	1.2	0.9	0.0	0.1	-1.2
8	N	0.0	0.0	0.0	0.0	0.4	5.3	0.0	0.0
	MX	0.2	0.1	-0.1	-0.1	0.0	0.0	0.0	0.1
	QY	0.0	0.0	0.0	0.0	0.0	0.0	0.0	0.0
	MU	2.6	3.3	2.7	2.7	3.7	0.9	0.0	2.6
	QX	-0.5	-0.7	-0.5	-0.5	-0.4	-0.7	0.3	-0.5
9	N	0.0	0.0	0.0	0.0	7.8	3.0	0.0	0.0
	MX	-2.4	-2.5	0.5	0.6	-0.8	-0.7	0.0	-2.7
	QY	-0.5	-0.5	0.3	0.6	-0.6	-0.2	0.2	-0.6
	MU	-1.4	-0.7	-1.4	-0.8	0.9	-0.3	0.0	-1.5
	QX	0.4	-0.2	-0.4	0.3	0.2	0.2	0.0	0.4
14	N	-67.0	-93.2	-79.5	-102.0	-47.7	-77.7	-44.1	-118.1
	MX	-0.7	0.0	1.3	0.0	0.9	1.1	0.0	3.0
	QY	-0.5	0.0	0.9	0.0	0.5	0.7	0.0	1.4
	MU	-1.0	1.5	-0.2	-0.2	-0.4	-1.3	0.0	0.0
	QX	0.7	-1.1	0.1	0.1	0.4	0.7	0.0	0.0

1.220.1-3М.0-1.4 25МУ2

ЛИСТ

2

ФОРМАТ А4

Номер загрузки	Тип усилия	Номер группы элементов							
		1	2	3	4	5	6	7	8
ЯРУС 3 СЕЧЕНИЕ 1									
1	N	0.0	0.0	0.0	0.0	1.7	0.1	0.0	0.0
	MX	1.7	1.2	2.2	1.5	0.6	1.4	-0.0	1.3
	QY	-0.6	-0.4	-0.8	-0.6	-0.2	-0.2	0.0	-0.2
	MU	-2.3	1.9	1.0	1.2	-1.9	-1.2	0.0	-1.9
	QX	0.5	0.6	0.3	0.4	-0.3	-0.3	-0.0	-0.7
8	N	0.0	0.0	0.0	0.0	0.2	0.9	0.0	0.0
	MX	-0.2	-0.1	0.1	0.1	-0.4	-0.1	0.0	-0.1
	QY	0.0	0.0	0.0	0.0	0.1	0.0	0.0	0.0
	MU	-2.6	-3.3	-2.7	-2.7	-5.0	-7.6	0.0	-2.6
	QX	-0.3	-0.9	-0.3	-0.4	-1.2	-2.2	0.0	-0.3
9	N	0.0	0.0	0.0	0.0	-5.1	-0.5	0.0	0.0
	MX	2.4	2.5	-0.5	-0.6	6.9	2.8	0.0	2.7
	QY	-0.1	-0.2	0.2	0.2	-1.9	-0.9	0.0	-0.8
	MU	1.4	0.7	1.4	0.8	1.2	3.4	0.0	1.5
	QX	0.1	-0.1	-0.1	0.1	0.2	0.8	0.0	0.1
14	N	44.3	60.9	48.4	57.9	38.2	86.6	0.0	87.0
	MX	-0.4	0.0	-0.7	0.0	-0.8	-1.8	0.0	-1.0
	QY	0.3	0.0	0.2	0.0	0.3	1.3	0.0	1.2
	MU	1.1	-2.3	0.2	0.2	-2.4	1.4	0.0	0.0
	QX	0.6	0.8	0.1	0.1	-1.4	-0.4	0.0	0.0
ЯРУС 3 СЕЧЕНИЕ 2									
1	N	0.0	0.0	0.0	0.0	-1.7	-0.1	0.0	0.0
	MX	0.3	0.2	0.5	0.4	0.2	-0.7	0.0	-0.6
	QY	0.6	0.4	0.8	0.6	0.2	0.2	0.0	0.2
	MU	-0.4	0.9	0.1	0.1	1.0	-0.4	0.0	-0.4
	QX	-0.5	-0.6	-0.3	-0.4	0.3	0.3	0.0	0.7
8	N	0.0	0.0	0.0	0.0	-0.2	-0.9	0.0	0.0
	MX	0.1	0.1	0.1	0.1	0.1	0.1	0.0	0.1
	QY	0.0	0.0	0.0	0.0	-0.1	0.0	0.0	0.0
	MU	1.7	1.4	1.6	1.4	1.1	0.3	0.0	1.7
	QX	0.3	0.9	0.3	0.4	1.2	2.2	0.0	0.3
9	N	0.0	0.0	0.0	0.0	5.1	0.5	0.0	0.0
	MX	-2.0	-2.0	-0.1	-0.2	-0.8	0.5	0.0	-0.2
	QY	0.1	0.2	-0.2	-0.2	1.9	0.7	0.0	0.7
	MU	-1.1	-0.6	-1.1	-0.6	-0.6	-0.6	0.0	-1.1
	QX	-0.1	0.1	-0.1	-0.1	0.0	-0.8	0.0	0.1
14	N	-44.3	-60.9	-48.4	-57.9	-38.2	-86.6	0.0	-87.0
	MX	0.9	0.0	-0.1	0.0	0.4	2.5	0.0	3.0
	QY	0.2	0.0	0.2	0.0	0.2	1.3	0.0	1.2
	MU	0.8	-2.3	0.2	0.3	-2.3	0.5	0.0	0.0
	QX	0.4	-0.8	-0.1	-0.1	-0.2	-0.6	0.0	0.0

1.220.1-3М.0-1.4 25МУ2

ЛИСТ

3

ФОРМАТ А4

23171-04 97

Номер загрузки	Тип усилки	Номер группы элементов							
		1	2	3	4	5	6	7	8
ЯРУС 1 СЕЧЕНИЕ 1									
1	N	0.0	0.0	0.0	0.0	-16.1	-12.5	0.0	0.0
	MX	-2.5	-2.4	-4.1	-3.9	12.1	-5.4	-2.0	3.8
	QU	0.7	0.6	1.0	0.9	-6.9	2.0	0.5	-0.9
	MU	2.8	-4.7	-3.0	-4.4	6.6	5.7	2.9	3.1
	QX	-0.7	-1.1	-0.6	-1.0	-2.0	-1.6	-0.2	0.6
8	N	0.0	0.0	0.0	0.0	-0.2	-25.7	0.0	0.0
	MX	0.0	0.1	0.0	0.1	0.0	0.0	0.0	0.0
	QU	0.0	0.0	0.0	0.0	0.0	0.0	0.0	0.0
	MU	-1.2	-2.0	-2.0	-3.2	-3.3	-6.7	-1.4	-2.0
	QX	-0.4	-0.5	-0.5	-0.8	-1.0	-3.8	-0.3	-0.5
9	N	0.0	0.0	0.0	0.0	44.0	-1.8	0.0	0.0
	MX	1.3	2.1	1.8	3.0	14.4	2.2	1.6	2.1
	QU	-0.4	-0.6	-0.4	-0.7	-8.3	-0.7	-0.4	-0.6
	MU	0.2	-0.1	0.1	0.1	0.0	0.2	0.0	0.2
	QX	0.1	0.0	-0.1	0.0	0.0	0.1	0.0	0.1
14	N	117.1	159.4	143.3	184.4	154.3	136.5	126.5	181.9
	MX	0.5	0.0	-1.2	0.0	2.6	-1.1	0.0	-0.9
	QU	-0.4	0.0	0.9	0.0	-2.0	0.9	0.0	0.8
	MU	1.0	-1.8	0.1	0.0	-1.6	-1.2	0.0	0.0
	QX	0.7	-1.3	0.0	0.0	0.0	0.9	0.0	0.0
ЯРУС 1 СЕЧЕНИЕ 2									
1	N	0.0	0.0	0.0	0.0	16.1	12.5	0.0	0.0
	MX	0.0	0.3	0.5	0.8	12.1	-1.6	0.3	-0.5
	QU	0.5	-0.6	-1.0	-0.9	6.9	-2.0	-0.5	0.9
	MU	0.0	0.6	0.4	0.9	1.9	5.8	-0.4	-0.4
	QX	0.8	1.1	0.6	1.0	2.0	1.6	0.2	-0.6
8	N	0.0	0.0	0.0	0.0	0.2	25.7	0.0	0.0
	MX	0.0	0.0	0.0	0.0	0.0	0.0	0.0	0.0
	QU	0.0	0.0	0.0	0.0	0.0	0.0	0.0	0.0
	MU	-0.2	0.1	0.1	0.5	-0.2	-6.7	0.3	0.1
	QX	0.4	0.5	0.5	0.8	1.0	3.8	0.3	0.5
9	N	0.0	0.0	0.0	0.0	-44.0	1.8	0.0	0.0
	MX	0.2	-0.3	-0.3	-0.7	14.5	0.4	-0.3	-0.1
	QU	0.4	-0.4	0.4	0.7	8.3	0.7	0.4	0.6
	MU	0.1	-0.1	0.1	0.1	0.0	-0.2	0.0	0.1
	QX	-0.1	0.0	-0.1	0.0	0.0	-0.1	0.0	0.1
14	N	-117.1	-159.4	-143.3	-184.4	-154.3	-136.5	-126.5	-181.9
	MX	-0.8	0.0	-2.0	0.0	4.5	-1.7	0.0	-1.9
	QU	-0.4	0.0	-0.9	0.0	2.0	-0.8	0.0	-0.8
	MU	1.5	-2.7	0.0	0.0	-2.3	-2.0	0.0	0.0
	QX	-0.7	1.3	0.0	0.0	0.0	-0.9	0.0	0.0

1.220.1-3М.0-1.4 25МУЗ

ГИП	Егумов								
И.КОНТР.	Бойко								
РУКЛР.	Рудавки								
ПРОВЕРИЛ	Футормая								
РАЗРАБ	Эуежко								
ЗДАНИЕ					СТАДИЯ	ЛИСТ	ЛИСТОВ		
4Т 4.5.30-ЗАЛ(24)32-3.5					Р	1	4		
КиевЗНИИЭП					ГОСГРАЖДАНСТРОЙ				

ФОРМАТ А4

Номер загрузки	Тип усилки	Номер группы элементов							
		1	2	3	4	5	6	7	8
ЯРУС 2 СЕЧЕНИЕ 1									
1	N	0.0	0.0	0.0	0.0	2.1	2.6	0.0	0.0
	MX	0.0	-0.3	-0.5	-0.8	-0.3	-0.5	-0.3	0.5
	QU	-0.5	0.6	1.0	0.9	0.2	0.9	0.5	-0.9
	MU	0.0	-0.6	-0.4	-0.9	-0.7	0.1	0.4	0.4
	QX	-0.8	-1.1	-0.6	-1.0	-1.0	-0.1	-0.2	0.6
8	N	0.0	0.0	0.0	0.0	-0.3	11.8	0.0	0.0
	MX	0.0	0.0	0.0	0.0	0.0	0.0	0.0	0.0
	QU	0.0	0.0	0.0	0.0	0.0	0.0	0.0	0.0
	MU	0.2	-0.1	-0.1	-0.5	-0.5	-0.3	-0.3	-0.1
	QX	-0.4	-0.5	-0.5	-0.8	-0.6	-0.2	-0.3	-0.5
9	N	0.0	0.0	0.0	0.0	-17.1	-2.0	0.0	0.0
	MX	-0.2	0.3	0.3	0.7	0.5	0.2	0.3	0.1
	QU	-0.4	-0.4	-0.4	-0.7	-0.3	-0.4	-0.4	-0.6
	MU	-0.1	0.1	-0.1	-0.1	0.0	0.0	0.0	-0.1
	QX	0.1	0.0	0.1	0.0	0.0	0.0	0.0	-0.1
14	N	89.6	125.4	110.5	146.1	67.0	70.8	88.2	149.1
	MX	-0.6	0.0	1.2	0.0	-0.8	-0.4	0.0	1.3
	QU	0.4	0.0	-0.9	0.0	0.4	0.3	0.0	-0.8
	MU	-0.9	1.4	0.0	0.0	-0.6	0.5	0.0	0.0
	QX	-0.7	-1.3	0.0	0.0	0.0	0.1	0.0	0.0
ЯРУС 2 СЕЧЕНИЕ 2									
1	N	0.0	0.0	0.0	0.0	-2.1	-2.6	0.0	0.0
	MX	-1.7	-1.1	-1.9	-1.3	-0.2	-1.8	-0.9	1.8
	QU	-0.7	-0.6	-1.0	-0.9	-0.2	-1.0	-0.5	0.9
	MU	2.0	-2.2	-1.4	-1.4	2.1	0.1	1.3	1.4
	QX	0.7	1.1	0.6	1.0	1.0	-0.1	0.2	-0.6
8	N	0.0	0.0	0.0	0.0	0.3	-11.8	0.0	0.0
	MX	0.1	0.1	0.0	0.0	0.0	0.0	0.0	-0.1
	QU	0.0	0.0	0.0	0.0	0.0	0.0	0.0	0.0
	MU	-1.1	-1.3	-1.3	-1.4	-0.9	-0.2	-0.5	-1.2
	QX	0.4	0.5	0.5	0.8	0.6	0.2	0.3	0.5
9	N	0.0	0.0	0.0	0.0	17.1	2.0	0.0	0.0
	MX	1.3	1.3	0.7	0.9	0.3	0.7	0.6	1.4
	QU	0.4	0.6	0.4	0.7	0.3	0.4	0.4	0.6
	MU	0.4	-0.2	0.3	0.2	-0.1	0.0	0.0	0.4
	QX	-0.1	0.0	0.1	0.0	0.0	0.0	0.0	-0.1
14	N	-89.6	-125.4	-110.5	-146.1	-67.0	-70.8	-88.2	-149.1
	MX	-0.4	0.0	-1.0	0.0	0.3	-0.3	0.0	-0.6
	QU	-0.4	0.0	-0.9	0.0	0.0	-0.3	0.0	-0.8
	MU	0.8	-1.7	0.1	0.1	-0.5	-0.2	0.0	0.0
	QX	-0.7	1.3	0.0	0.0	-0.4	-0.1	0.0	0.0

ИВН № ПОДЛ ПОДПИСИ И ДАТА ВЗАМ ИВН №

1.220.1-3М.0-1.4 25МУЗ

ЛИСТ
2

23171-04 98

ФОРМАТ А4

Номер загрузки	Тип усилки	Номер группы элементов							
		1	2	3	4	5	6	7	8
ЯРУС 3 СЕЧЕНИЕ 1									
1	N	0.0	0.0	0.0	0.0	1.1	1.3	0.0	0.0
	MX	1.7	1.1	1.9	1.3	0.1	1.6	0.9	-1.8
	QU	-0.6	-0.4	-0.7	-0.5	0.0	-0.7	-0.3	0.6
	MU	-2.0	2.2	1.4	1.4	-2.0	0.1	-1.3	-1.4
	QX	0.6	0.8	0.4	0.5	-0.8	0.0	0.1	-0.4
8	N	0.0	0.0	0.0	0.0	-0.5	8.6	0.0	0.0
	MX	-0.1	-0.1	0.0	0.0	0.0	0.0	0.0	0.1
	QU	0.0	0.0	0.0	0.0	0.0	0.0	0.0	-0.1
	MU	1.1	1.3	1.3	1.4	2.0	0.0	0.5	1.2
	QX	1.3	1.3	1.4	1.4	0.7	0.0	0.2	1.3
9	N	0.0	0.0	0.0	0.0	-10.7	-3.0	0.0	0.0
	MX	-1.3	-1.3	-0.7	-0.9	0.3	-0.9	-0.6	-1.4
	QU	1.3	1.3	0.3	0.3	-0.1	0.6	0.2	1.4
	MU	-0.4	0.2	-0.3	-0.2	0.3	-0.1	0.0	-0.4
	QX	-0.6	0.3	0.5	-0.3	0.0	-0.1	0.0	-0.6
14	N	67.0	93.2	79.5	102.0	38.2	63.5	44.1	118.1
	MX	-0.5	0.0	1.0	0.0	0.6	0.7	0.0	1.4
	QU	0.4	0.0	-0.7	0.0	-0.5	-0.6	0.0	-1.3
	MU	-1.1	1.6	-0.1	-0.1	-0.5	-0.8	0.0	0.0
	QX	-0.6	-0.6	-0.1	-0.1	-0.3	0.7	0.0	0.0
ЯРУС 3 СЕЧЕНИЕ 2									
1	N	0.0	0.0	0.0	0.0	-1.1	-1.3	0.0	0.0
	MX	0.4	0.2	0.5	0.3	0.1	0.7	0.0	-0.3
	QU	0.6	0.4	0.7	0.5	0.0	0.7	-0.2	-0.6
	MU	-0.4	0.4	0.3	0.3	-0.8	-0.1	0.0	-0.3
	QX	-0.6	-0.8	-0.4	-0.5	0.8	0.0	-0.1	0.4
8	N	0.0	0.0	0.0	0.0	0.5	-8.6	0.0	0.0
	MX	0.2	0.1	-0.1	-0.1	0.0	0.1	0.0	0.2
	QU	0.1	0.0	0.0	0.0	0.0	0.0	0.0	0.1
	MU	3.1	3.8	3.2	3.3	3.9	0.1	0.0	3.2
	QX	-1.3	-1.5	-1.4	-1.4	-0.7	0.0	-0.2	-1.3
9	N	0.0	0.0	0.0	0.0	10.7	3.0	0.0	0.0
	MX	-3.2	-3.1	-0.2	-0.2	0.2	-1.1	0.0	-3.2
	QU	-1.3	-1.3	-0.3	-0.3	0.1	-0.6	-0.2	-1.4
	MU	-1.6	-0.8	-1.5	-0.8	0.8	-0.2	0.0	-1.6
	QX	0.6	-0.3	-0.5	0.3	0.0	0.1	0.0	0.6
14	N	-67.0	-93.2	-79.5	-102.0	-38.2	-63.5	-44.1	-118.1
	MX	-0.8	0.0	1.2	0.0	1.1	1.1	0.0	3.1
	QU	-0.4	0.0	0.7	0.0	0.5	0.6	0.0	1.3
	MU	-1.1	1.5	-0.2	-0.2	-0.3	-1.5	0.0	0.1
	QX	0.6	0.6	0.1	0.1	0.3	0.7	0.0	0.0

Классификация

ЛИСТ
3

1.220.1-3M.0-1.4 25МУЗ

Номер загрузки	Тип усилки	Номер группы элементов							
		1	2	3	4	5	6	7	8
ЯРУС 4 СЕЧЕНИЕ 1									
1	N	0.0	0.0	0.0	0.0	0.2	0.0	0.0	0.0
	MX	-0.4	-0.2	-0.5	-0.3	-0.1	0.0	0.0	0.3
	QU	0.1	0.1	0.2	0.1	0.0	0.0	0.0	0.0
	MU	-0.4	-0.4	-0.3	-0.3	0.1	0.1	0.0	0.3
	QX	-0.1	-0.2	-0.1	-0.1	0.0	0.0	0.0	0.1
8	N	0.0	0.0	0.0	0.0	0.1	0.8	0.0	0.0
	MX	-0.2	-0.1	0.1	0.1	-0.4	-0.2	0.0	-0.2
	QU	0.0	0.0	-0.1	0.0	0.1	0.0	0.0	0.0
	MU	-3.1	-3.8	-3.2	-3.3	-4.9	-6.4	0.0	-3.2
	QX	-0.4	-1.0	-0.5	-0.6	-1.2	-1.7	0.0	-0.5
9	N	0.0	0.0	0.0	0.0	-5.6	-0.4	0.0	0.0
	MX	3.2	3.1	0.2	0.2	6.1	3.0	0.0	3.2
	QU	-0.4	-0.4	-0.1	-0.1	-1.5	-0.9	0.0	-0.9
	MU	1.6	0.8	1.5	0.8	1.1	3.0	0.0	1.6
	QX	0.2	-0.1	-0.2	0.1	0.2	0.7	0.0	0.2
14	N	44.3	60.9	48.4	57.9	38.2	86.6	0.0	87.0
	MX	-0.5	0.0	-0.8	0.0	-1.1	-1.9	0.0	-1.1
	QU	0.3	0.0	0.2	0.0	0.4	1.3	0.0	1.2
	MU	1.0	-2.3	0.2	0.2	-2.3	1.8	0.0	-0.1
	QX	0.5	-1.4	0.1	0.1	-1.4	-0.6	0.0	0.0
ЯРУС 4 СЕЧЕНИЕ 2									
1	N	0.0	0.0	0.0	0.0	-0.2	0.0	0.0	0.0
	MX	-0.1	-0.1	-0.1	-0.1	0.0	0.0	0.0	-0.1
	QU	-0.1	-0.1	-0.2	-0.1	0.0	0.0	0.0	0.0
	MU	0.1	-0.2	0.0	0.0	0.0	0.0	0.0	0.1
	QX	-0.2	0.2	0.1	0.1	0.0	0.0	0.0	-0.1
8	N	0.0	0.0	0.0	0.0	-0.1	-0.8	0.0	0.0
	MX	0.1	0.1	0.1	0.1	0.1	0.1	0.0	0.1
	QU	0.0	0.0	0.1	0.0	-0.1	0.0	0.0	0.0
	MU	1.6	1.4	1.5	1.3	1.1	0.6	0.0	1.6
	QX	0.5	1.0	0.5	0.6	1.2	1.7	0.0	0.5
9	N	0.0	0.0	0.0	0.0	5.6	0.4	0.0	0.0
	MX	-1.9	-1.9	0.0	0.0	-1.0	0.4	0.0	-0.5
	QU	0.3	0.4	0.0	0.1	1.5	0.7	0.0	0.8
	MU	-1.0	-0.5	-1.0	-0.5	-0.6	-0.6	0.0	-1.0
	QX	0.2	0.1	-0.1	-0.1	0.0	-0.7	0.0	0.2
14	N	-44.3	-60.9	-48.4	-57.9	-38.2	-86.6	0.0	-87.0
	MX	0.9	0.0	-0.1	0.0	0.6	2.5	0.0	2.9
	QU	0.3	0.0	0.2	0.0	0.4	1.3	0.0	1.2
	MU	0.8	-2.3	0.2	0.3	-2.3	0.6	0.0	0.0
	QX	0.4	-0.8	-0.1	-0.1	-0.2	0.6	0.0	0.0

ИНВ № ПОДЛ
ПОДПИСЬ И ДАТА
ВЗАМ. ИНВ. №

САПР
Классификация

Безудовольствия

ЛИСТ
4

1.220.1-3M.0-1.4 25МУЗ

Номер загрузки	Тип усилки	Номер группы элементов							
		1	2	3	4	5	6	7	8
ЯРУС 1 СЕЧЕНИЕ 1									
1	N	0.0	0.0	0.0	0.0	-23.1	-18.1	0.0	0.0
	MX	-4.3	-4.2	-7.2	-6.6	22.9	-8.8	-3.5	6.8
	QU	1.0	0.9	1.5	1.3	-11.4	2.4	0.7	-1.4
	MU	5.0	-8.2	-5.3	-7.4	-11.0	10.8	5.1	5.5
	QX	-0.9	-1.6	-0.8	-1.4	-2.6	-2.7	-0.2	0.9
8	N	0.0	0.0	0.0	0.0	-0.2	-26.8	0.0	0.0
	MX	0.0	0.1	0.1	0.1	-0.1	0.1	0.0	-0.1
	QU	0.0	0.0	0.0	0.0	0.0	0.0	0.0	0.0
	MU	-1.3	-2.3	-2.3	-3.5	-3.3	-7.5	-1.5	-2.3
	QX	-0.3	-0.5	-0.5	-0.7	-0.7	-3.8	-0.3	-0.5
9	N	0.0	0.0	0.0	0.0	45.1	1.4	0.0	0.0
	MX	1.5	2.4	2.1	3.4	17.6	2.4	1.9	2.5
	QU	-0.4	-0.5	-0.4	-0.6	-8.8	-0.6	-0.4	-0.6
	MU	0.2	-0.1	0.1	0.1	0.1	-0.5	-0.1	0.3
	QX	0.1	0.0	-0.1	0.0	0.0	0.3	0.0	0.1
14	N	117.1	159.4	143.3	184.4	158.9	142.6	126.5	181.9
	MX	-0.6	0.0	-1.1	0.0	4.7	-1.2	0.0	-0.7
	QU	0.4	0.0	0.8	0.0	-3.3	0.8	0.0	0.7
	MU	1.1	-1.9	0.1	0.1	-1.7	-2.2	0.0	0.0
	QX	0.7	-1.2	0.0	0.0	0.0	1.5	0.0	0.0
ЯРУС 1 СЕЧЕНИЕ 2									
1	N	0.0	0.0	0.0	0.0	23.1	18.1	0.0	0.0
	MX	0.5	0.8	1.3	1.5	22.5	-0.8	0.7	-1.3
	QU	-1.0	-0.9	-1.5	-1.3	11.4	-2.4	-0.7	1.4
	MU	-0.6	1.6	1.0	1.7	0.9	11.0	-1.0	-1.0
	QX	0.9	1.6	0.8	1.4	2.6	2.7	0.2	-0.9
8	N	0.0	0.0	0.0	0.0	0.2	26.8	0.0	0.0
	MX	0.0	0.0	0.0	0.0	0.0	0.0	0.0	0.0
	QU	0.0	0.0	0.0	0.0	0.0	0.0	0.0	0.0
	MU	-0.1	0.2	0.2	0.6	0.4	-7.5	0.4	0.2
	QX	0.3	0.5	0.5	0.7	0.7	3.8	0.3	0.5
9	N	0.0	0.0	0.0	0.0	-45.1	-1.4	0.0	0.0
	MX	-0.2	-0.5	-0.4	-0.8	17.5	-0.1	-0.4	-0.2
	QU	0.2	0.4	0.4	0.6	8.8	0.6	0.4	0.6
	MU	0.1	0.1	0.1	0.1	-0.1	-0.5	0.0	0.1
	QX	-0.1	0.0	-0.1	0.0	0.0	0.3	0.0	0.1
14	N	-117.1	-159.4	-143.3	-184.4	-158.9	-142.6	-126.5	-181.9
	MX	-0.9	0.0	-2.2	0.0	8.4	-2.0	0.0	-2.1
	QU	-0.4	0.0	-0.8	0.0	3.3	-0.8	0.0	-0.7
	MU	1.7	-2.9	0.0	0.0	-2.7	-4.0	0.0	0.0
	QX	-0.7	-1.1	0.0	0.0	0.0	-1.5	0.0	0.0

1.220.1-3M.0-1.4 25M/4

ТИП	Егузов			
И.КОНТР.	Бойко			
РУКЛР.	Рудак			
ПРОВЕРИЛ	Футормя			
РАЗРАБ	Зуежко			
ЗДАНИЕ		4Т 4.5, 30-ЗАЛ (24) 40-4.0		
СТАДИЯ	ЛИСТ	ЛИСТОВ		
Р	1	4		
ГОСГРАЖДАНСТРОЯ		КиевЗНИИЭП		

Номер загрузки	Тип усилки	Номер группы элементов							
		1	2	3	4	5	6	7	8
ЯРУС 2 СЕЧЕНИЕ 1									
1	N	0.0	0.0	0.0	0.0	2.6	3.3	0.0	0.0
	MX	-0.5	-0.8	-1.3	-1.5	-0.4	-0.8	-0.7	1.3
	QU	1.0	0.9	1.5	1.3	0.3	1.1	0.7	-1.4
	MU	0.6	-1.6	-1.0	-1.7	-1.1	0.1	1.0	1.0
	QX	-0.9	-1.6	-0.8	-1.4	-1.2	0.1	-0.2	0.9
8	N	0.0	0.0	0.0	0.0	-0.3	11.1	0.0	0.0
	MX	0.0	0.0	0.0	0.0	0.0	0.0	0.0	0.0
	QU	0.0	0.0	0.0	0.0	0.0	0.0	0.0	0.0
	MU	0.1	-0.2	-0.2	-0.6	-0.5	-0.3	-0.4	-0.2
	QX	-0.3	-0.5	-0.5	-0.7	-0.5	-0.2	-0.3	-0.5
9	N	0.0	0.0	0.0	0.0	-15.3	-2.1	0.0	0.0
	MX	0.2	0.5	0.4	0.8	0.3	0.2	0.4	0.2
	QU	-0.2	-0.4	-0.4	-0.6	-0.2	-0.3	-0.4	-0.6
	MU	-0.1	-0.1	-0.1	-0.1	0.0	0.0	0.0	-0.1
	QX	0.1	0.0	0.1	0.0	0.0	0.0	0.0	-0.1
14	N	89.6	125.4	110.5	146.1	65.1	70.4	88.2	149.1
	MX	-0.5	0.0	1.0	0.0	-0.8	-0.4	0.0	1.1
	QU	0.3	0.0	-0.8	0.0	0.4	0.3	0.0	-0.7
	MU	-0.8	1.2	0.0	0.0	-0.5	-0.5	0.0	0.0
	QX	-0.7	1.1	0.0	0.0	0.0	0.2	0.0	0.0
ЯРУС 2 СЕЧЕНИЕ 2									
1	N	0.0	0.0	0.0	0.0	-2.6	-3.3	0.0	0.0
	MX	-1.8	-1.2	-2.1	-1.5	-0.3	-1.9	-1.0	2.0
	QU	-1.0	-0.9	-1.5	-1.3	-0.3	-1.1	-0.7	1.4
	MU	2.1	-2.4	-1.6	-1.7	2.3	0.2	1.4	1.6
	QX	0.9	1.6	0.8	1.4	1.2	-0.1	0.2	-0.9
8	N	0.0	0.0	0.0	0.0	0.3	-11.1	0.0	0.0
	MX	0.0	0.1	0.0	0.0	0.0	0.0	0.0	-0.1
	QU	0.0	0.0	0.0	0.0	0.0	0.0	0.0	0.0
	MU	-0.9	-1.2	-1.1	-1.2	-0.7	-0.2	-0.3	-1.0
	QX	0.3	0.5	0.5	0.7	0.5	0.2	0.3	0.5
9	N	0.0	0.0	0.0	0.0	15.3	2.1	0.0	0.0
	MX	1.0	1.1	0.5	0.7	0.2	0.5	0.4	1.2
	QU	0.4	0.5	0.4	0.6	0.2	0.3	0.4	0.6
	MU	-0.3	-0.2	0.3	0.2	-0.1	0.0	0.0	0.4
	QX	-0.1	0.0	0.1	0.0	0.0	0.0	0.0	-0.1
14	N	-89.6	-125.4	-110.5	-146.1	-65.1	-70.4	-88.2	-149.1
	MX	-0.4	0.0	-1.0	0.0	-0.3	-0.3	0.0	-0.6
	QU	-0.4	0.0	-0.8	0.0	0.0	-0.3	0.0	-0.7
	MU	-0.9	-1.7	0.1	0.1	-0.5	-0.2	0.0	0.0
	QX	-0.7	1.2	0.0	0.0	0.4	-0.2	0.0	0.0

Безудово
ОПЕРАТОР СИСТЕМЫ
САПР КиевЗНИИЭП
ПОДПИСЬ И ДАТА
ИМЯ И ПОЛ

1.220.1-3M.0-1.4 25M/4

ЛИСТ 2

Номер загрузки	Тип усилия	Номер группы элементов							
		1	2	3	4	5	6	7	8
ЯРУС 3 СЕЧЕНИЕ 1									
1	N	0.0	0.0	0.0	0.0	1.4	1.6	0.0	0.0
	MX	1.8	1.2	2.1	1.5	-0.1	1.7	1.0	-2.0
	QY	-0.7	-0.5	-0.8	-0.6	0.0	-0.7	-0.3	0.7
	MU	-2.1	2.4	1.6	1.7	-2.0	-0.1	-1.4	-1.6
	QX	0.7	0.8	0.4	0.6	0.5	0.0	0.1	-0.5
8	N	0.0	0.0	0.0	0.0	-0.5	8.3	0.0	0.0
	MX	0.0	-0.1	0.0	0.0	0.0	0.0	0.0	0.0
	QY	0.0	0.0	0.0	0.0	0.0	0.0	0.0	-0.1
	MU	0.9	1.2	1.1	1.2	1.8	0.0	0.3	1.0
	QX	1.2	1.3	1.3	1.3	0.6	0.0	0.1	1.3
9	N	0.0	0.0	0.0	0.0	-10.2	-3.0	0.0	0.0
	MX	-1.0	-1.1	-0.5	-0.7	0.2	-0.7	-0.4	-1.2
	QY	1.3	1.3	0.2	0.3	-0.1	0.5	0.1	1.3
	MU	-0.3	0.2	-0.3	-0.2	0.3	-0.1	0.0	-0.4
	QX	-0.6	0.3	0.5	-0.3	0.0	-0.1	0.0	-0.6
14	N	67.0	93.2	79.5	102.0	38.1	63.3	44.1	118.1
	MX	-0.5	0.0	1.0	0.0	0.6	0.7	0.0	1.4
	QY	0.4	0.0	-0.7	0.0	-0.5	-0.5	0.0	-1.3
	MU	-1.0	1.5	-0.1	-0.1	-0.4	-0.8	0.0	0.0
	QX	-0.6	-0.6	-0.1	-0.1	-0.2	0.7	0.0	0.0
ЯРУС 3 СЕЧЕНИЕ 2									
1	N	0.0	0.0	0.0	0.0	-1.4	-1.6	0.0	0.0
	MX	0.4	0.3	0.5	0.4	0.1	0.7	0.0	-0.3
	QY	0.7	0.5	0.8	0.6	0.0	0.7	-0.2	-0.7
	MU	-0.5	0.5	0.3	0.3	-0.8	-0.1	0.0	-0.4
	QX	-0.7	-0.8	-0.4	-0.6	0.9	0.0	-0.2	0.5
8	N	0.0	0.0	0.0	0.0	0.5	-8.3	0.0	0.0
	MX	0.2	0.1	-0.1	-0.1	0.0	0.1	0.0	0.2
	QY	0.1	0.0	0.0	0.0	0.0	0.0	0.0	0.1
	MU	3.1	3.7	3.2	3.2	3.9	0.2	0.0	3.1
	QX	-1.2	-1.5	-1.3	-1.3	-0.6	0.0	-0.1	-1.3
9	N	0.0	0.0	0.0	0.0	10.2	3.0	0.0	0.0
	MX	-3.2	-3.1	-0.1	-0.2	-0.2	-1.0	0.0	-3.2
	QY	-1.3	-1.3	-0.2	-0.3	-0.1	-0.5	-0.1	-1.3
	MU	-1.6	-0.8	-1.5	-0.8	0.8	-0.2	0.0	-1.6
	QX	0.6	-0.3	-0.5	0.3	0.1	0.1	0.0	0.6
14	N	-67.0	-93.2	-79.5	-102.0	-38.1	-63.3	-44.1	-118.1
	MX	-0.8	0.0	1.2	0.0	1.1	1.1	0.0	3.1
	QY	-0.4	0.0	0.7	0.0	0.5	0.5	0.0	1.3
	MU	-1.0	1.5	-0.2	-0.2	-0.3	-1.5	0.0	0.1
	QX	0.6	0.6	0.1	0.1	0.2	0.7	0.0	0.0

ФОРМАТ А4

Номер загрузки	Тип усилия	Номер группы элементов							
		1	2	3	4	5	6	7	8
ЯРУС 4 СЕЧЕНИЕ 1									
1	N	0.0	0.0	0.0	0.0	0.3	0.0	0.0	0.0
	MX	-0.4	-0.3	-0.5	-0.4	-0.1	0.0	0.0	0.3
	QY	0.1	0.1	0.2	0.1	0.0	0.0	0.0	0.0
	MU	0.5	-0.5	-0.3	-0.3	0.0	0.1	0.0	0.4
	QX	-0.1	-0.2	-0.1	-0.1	0.0	0.0	0.0	0.1
8	N	0.0	0.0	0.0	0.0	0.1	0.8	0.0	0.0
	MX	-0.2	-0.1	0.1	0.1	-0.4	-0.2	0.0	-0.2
	QY	0.0	0.0	-0.1	0.0	0.1	0.0	0.0	0.0
	MU	-3.1	-3.7	-3.2	-3.2	-5.0	-6.4	0.0	-3.1
	QX	-0.4	-1.0	-0.5	-0.6	-1.2	-1.8	0.0	-0.5
9	N	0.0	0.0	0.0	0.0	-5.5	-0.4	0.0	0.0
	MX	3.2	3.1	0.1	0.2	6.1	3.0	0.0	3.2
	QY	-0.4	-0.4	0.0	0.0	-1.6	-0.9	0.0	-0.9
	MU	1.6	0.8	1.5	0.8	1.1	3.0	0.0	1.6
	QX	0.2	-0.1	-0.2	0.1	0.2	0.7	0.0	0.2
14	N	44.3	60.9	48.4	57.9	38.2	86.6	0.0	87.0
	MX	-0.5	0.0	-0.8	0.0	-1.1	-1.9	0.0	-1.1
	QY	0.3	0.0	0.2	0.0	0.4	1.3	0.0	1.2
	MU	1.0	-2.3	0.2	0.2	-2.3	1.8	0.0	-0.1
	QX	0.6	-1.4	0.1	0.1	-1.4	-0.6	0.0	0.0
ЯРУС 4 СЕЧЕНИЕ 2									
1	N	0.0	0.0	0.0	0.0	-0.3	0.0	0.0	0.0
	MX	-0.1	-0.1	-0.1	-0.1	0.0	0.0	0.0	-0.2
	QY	-0.1	-0.1	-0.2	-0.1	0.0	0.0	0.0	0.0
	MU	0.1	-0.2	-0.1	0.0	0.0	0.0	0.0	0.1
	QX	-0.2	0.2	0.1	0.1	0.0	0.0	0.0	-0.1
8	N	0.0	0.0	0.0	0.0	-0.1	-0.8	0.0	0.0
	MX	0.1	0.1	0.1	0.1	0.1	0.1	0.0	0.1
	QY	0.0	0.0	0.1	0.0	-0.1	0.0	0.0	0.0
	MU	1.6	1.4	1.5	1.3	1.1	0.6	0.0	1.6
	QX	0.4	1.0	0.5	0.6	1.2	1.8	0.0	0.5
9	N	0.0	0.0	0.0	0.0	5.5	0.4	0.0	0.0
	MX	-1.9	-1.9	0.0	0.0	-1.0	0.4	0.0	-0.5
	QY	0.3	0.4	0.0	0.0	1.5	0.7	0.0	0.8
	MU	-1.0	-0.5	-1.0	-0.5	-0.6	-0.6	0.0	-1.0
	QX	0.2	0.1	-0.1	-0.1	0.0	-0.7	0.0	0.2
14	N	-44.3	-60.9	-48.4	-57.9	-38.2	-86.6	0.0	-87.0
	MX	0.9	0.0	-0.1	0.0	0.6	2.5	0.0	2.9
	QY	0.3	0.0	0.2	0.0	0.4	1.3	0.0	1.2
	MU	0.8	-2.3	0.2	0.3	-2.3	0.6	0.0	0.0
	QX	0.4	-0.8	-0.1	-0.1	-0.2	0.6	0.0	0.0

23171-04 101

ФОРМАТ А4

Классификация

Безудора
ОПЕРАТОР СИСТЕМЫ
САПР
Классификация

ИНВ № ПОДЛ
ПОДПИСЬ И ДАТА
ВЗАМ ИНВ №

ЛИСТ
3

ЛИСТ
4

МАРКА ПОЗ.	ОБОЗНАЧЕНИЕ	НАИМЕНОВАНИЕ	КОП.	МАССА ЕД. КГ	ПРИМЕЧАНИЕ
		ДОКУМЕНТАЦИЯ			
A3	I.220.I-3M.0-I.4 00T0	ТЕХНИЧЕСКОЕ ОПИСАНИЕ СБОРОЧНЫЕ ЕДИНИЦЫ РИГЕЛЬ			
P1	I.220.I-3M.3-I 03-02	РДП4.53-30	12	2518	
P2	I.220.I-3M.3-I 01-01	РДП4.53-90АТУ	22	2518	
P9	I.220.I-3M.3-I 09	Р4.57-20	20	1710	
P10	I.020-I/83.3-I 07-01	РОП 4.57-30	12	2070	
P12	I.020-I/83.3-I 02-02	РДП 4.57-60АТУ	6	2600	
		СВЯЗЕВАЯ ПЛИТА			
P13	I.041.I-2.I.400-01	ПК56.15-6АТИУС(А1У)Т-2	13	2600	
	ПЕРЕМЕННЫЕ ДАННЫЕ	ДЛЯ ИСПОЛНЕНИЯ I.220.I-3M.0-I.4 26 3Т 6.5.30-ЗАЛ(2x12) 40-4.0			
		РОСТБЕРК			
Ф1	I.220.I-3M.I-I 04-01	2Ф3-40	4	3625	
Ф2	I.220.I-3M.I-I 03-01	1Ф3-40	18	3755	
Ф3	I.220.I-3M.I-I 03-01	1Ф3-40	6	3755	
Ф4	I.220.I-3M.I-I 02-01	Ф2-40	4	2575	
Ф5	I.220.I-3M.I-I 03-01	1Ф3-40	2	3755	
Ф6		1ФД9-40	2		
Ф8		1ФД9-40	2		
		КОЛОННА			
K1	I.220.I-3M.2-I 13	КОЗТ 3.33-25.2	4	2373	
K2	I.220.I-3M.2-I 17-02	КОЗТ 3.33-25.3	4	2414	
K3	I.220.I-3M.2-I 11	КДЗТ 3.33-25.2	10	2441	
K4	I.220.I-3M.2-I 13	КОЗТ 3.33-25.2	4	2373	
		I.220.I-3M.0-I.4 26			
НАЧ ОД	Шевченко	ЗДАНИЕ 3Т 6.5-ЗАЛ(2x12) 4Т 6.5-ЗАЛ(2x12)	СТАДИЯ	ЛИСТ	ЛИСТОВ
НКОНТР.	Егунов		Р	1	3
ГЛ СПЕЦ	Рудавин		ГОСГРАЖДАНСТРОЙ		
ПРОБЕРИП	Зученко		КиевЗНИИЭП		
РАЗРАБ	Безгудова				

МАРКА ПОЗ.	ОБОЗНАЧЕНИЕ	НАИМЕНОВАНИЕ	КОП.	МАССА ЕД. КГ	ПРИМЕЧАНИЕ
K5	I.220.I-3M.2-I 11-01	КДЗТ 3.33-25.3	4	2496	
K6	I.220.I-3M.2-I 09	КДЗТ 3.33-25.1	4	776	
K7	I.220.I-3M.2-I 15-06	КДФЗТ 3.33-25.2	4	2396	
K8	I.220.I-3M.2-I 13	КОЗТ 3.33-25.2	2	2373	
K9	I.220.I-3M.2-I 13	КОЗТ 3.33-25.2	2	2373	
K10	I.220.I-3M.2-I 11-01	КДЗТ 3.33-25.3	2	2496	
K11	I.220.I-3M.2-I 11-01	КДЗТ 3.33-25.3 РИГЕЛЬ	2	2496	
P3	I.020-I/83.3-I 07-02	РОП 4.57-40	32	2070	
P4	I.020-I/83.3-I 02-03	РДП 4.57-70АТУ	28	2600	
		СВЯЗЕВАЯ ПЛИТА			
P11	I.041.I-2.I.200-01	ПК56.12-8АТИУС(А1У)Т-1	18	2000	
P12	I.041.I-2.I.400-02	ПК56.15-8АТИУС(А1У)Т-2 I.220.I-3M.0-I.4 26-01 4Т 6.5.30-ЗАЛ(2x12) 40-4.0	36	2600	
		РОСТБЕРК			
Ф1	I.220.I-3M.I-I 04-01	2Ф3-40	4	3625	
Ф2	I.220.I-3M.I-I 03-01	1Ф3-40	18	3755	
Ф3	I.220.I-3M.I-I 05-01	Ф4-40	6	4100	
Ф4	I.220.I-3M.I-I 02-01	Ф2-40	4	2575	
Ф5	I.220.I-3M.I-I 05-01	Ф4-40	2	4100	
Ф6		1ФД11-40	2		
Ф8		1ФД11-40	2		
		КОЛОННА			
K1	I.220.I-3M.2-I 18	КО4Т 3.33-30.2	4	3179	
K2	I.220.I-3M.2-I 24-03	КОФ4Т 3.33-40.7	4	3248	
K3	I.220.I-3M.2-I 18-04	КД4Т 3.33-40.2	10	3252	
K4	I.220.I-3M.2-I 18	КО4Т 3.33-30.2	4	3179	
K5	I.220.I-3M.2-I 18-04	КД4Т 3.33-40.2	4	3269	
K6	I.220.I-3M.2-I 10	КДЗТ 3.33-25.1	4	1592	
K7	I.220.I-3M.2-I 27	КДФ4Т 3.33-30.2	4	3224	
K8	I.220.I-3M.2-I 18	КО4Т 3.33-30.2	2	3179	
K9	I.220.I-3M.2-I 18	КО4Т 3.33-30.2	2	3179	
K10	I.220.I-3M.2-I 18-04	КД4Т 3.33-40.2	2	3269	
		I.220.I-3M.0-I.4 26			
ПОДПИСЬ И ДАТА	ВЗАМ. ИМ. И В. №				ЛИСТ
ИМ. И В. ПОДП.					2

МАРКА ПОЗ.	ОБОЗНАЧЕНИЕ.	НАИМЕНОВАНИЕ	КОП.	МАССА ЕД. КГ	ПРИМЕЧАНИЕ
К11	I.220.I-3M.2-I	КДЛТ 3.33-30.6 РИТЕЛЬ	2		
P3	I.020-I/83.3-I 07-02	РОП 4.57-40	44	2070	
P4	I.020-I/83.3-I 02-03	РДП 4.57-70АТУ СВЯЗЕВАЯ ПЛИТА	50	2600	
Р11	I.041.I-2.I.200-01	ПК56.12-8АТ1УС(АЛУ)Т-1	28	2000	
Р12	I.041.I-2.I.400-02	ПК56.15-8АТ1УС(АЛУ)Т-2	59	2600	

I.220.I-3M.0-I.4 26

ЛИСТ
3

Шахта
ОПЕРАТОР СИСТЕМЫ
САПР КиевЗНИИЭП
ИНВЕН ПОДП
ПОДПИСЬ И ДАТА
ВЗАМ ИНЖЕН

ЛИСТ

МОНТАЖНЫЙ ПЛАН РОСТВЕРКОВ

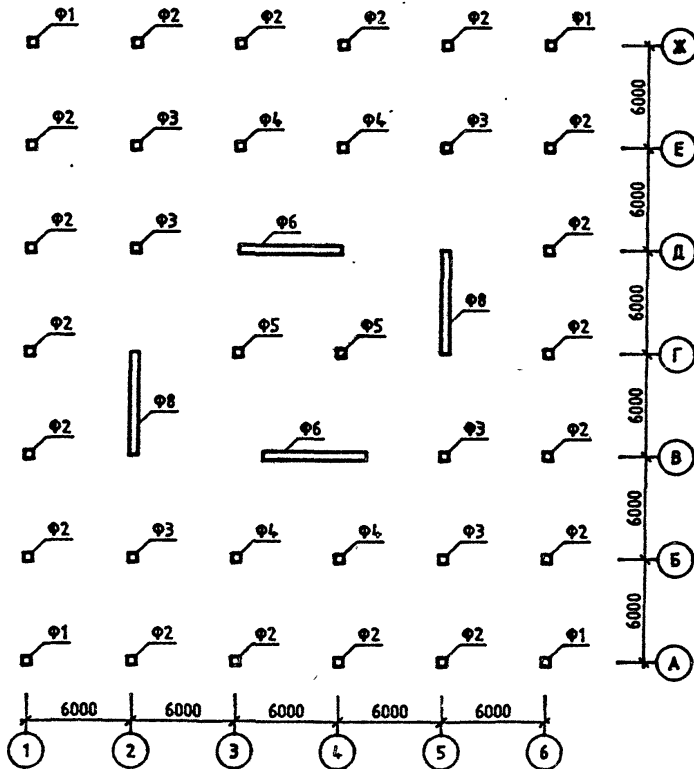

МОНТАЖНЫЙ ПЛАН КОЛОНН

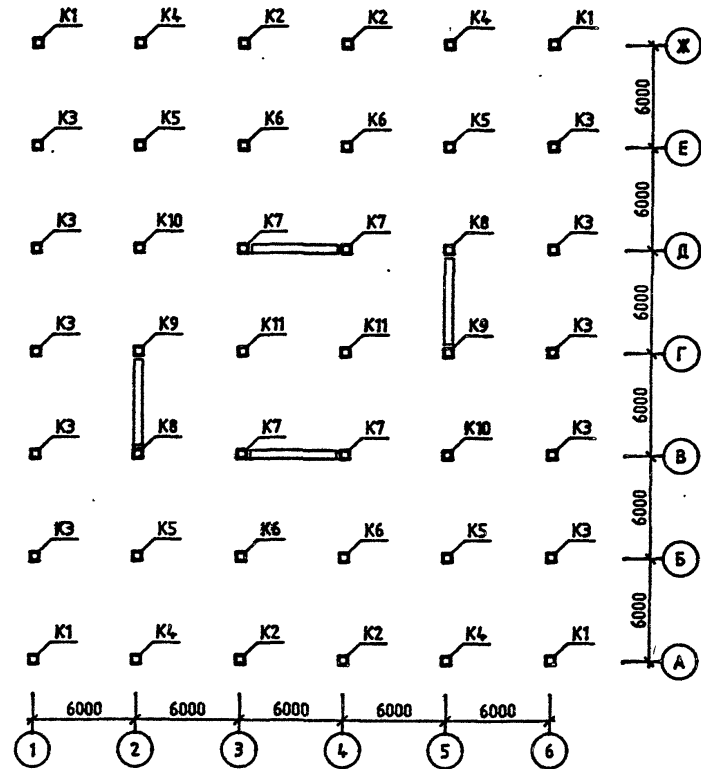

ОБОЗНАЧЕНИЕ	ШИФР ЗДАНИЯ
1220.1-3М.0-1.4 26 -01	ЭТ 6.5.30-3А/1(2*12)4.0-4.0 4Т 6.5.30-3А/1(2*12)4.0-4.0

1.220.1-3М.0-1.4 260Б				
ЗДАНИЕ ЭТ 6.5-3А/1(2*12) 4Т 6.5-3А/1(2*12)		СТАДИЯ	ЛИСТ	ЛИСТОВ
		Р	1	3
Исполнитель: Шевченко Гипр: Егузов Н.КОНТР.: Зуешко ПРОВЕРИЛ: Бобко РАЗРАБ.: Рудавица		ГОСГРАЖДАНСТРОЙ КиевЗНИИЭП		

МОНТАЖНЫЙ ПЛАН РИГЕЛЕЙ

ОТМ. -2.32

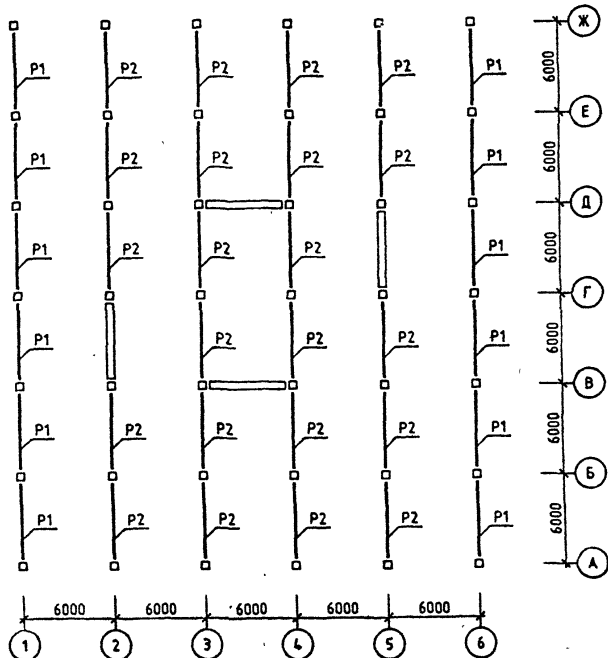

МОНТАЖНЫЙ ПЛАН РИГЕЛЕЙ И СВЯЗЕВЫХ ПЛИТ

ОТМ. -0.10 (+3.20)

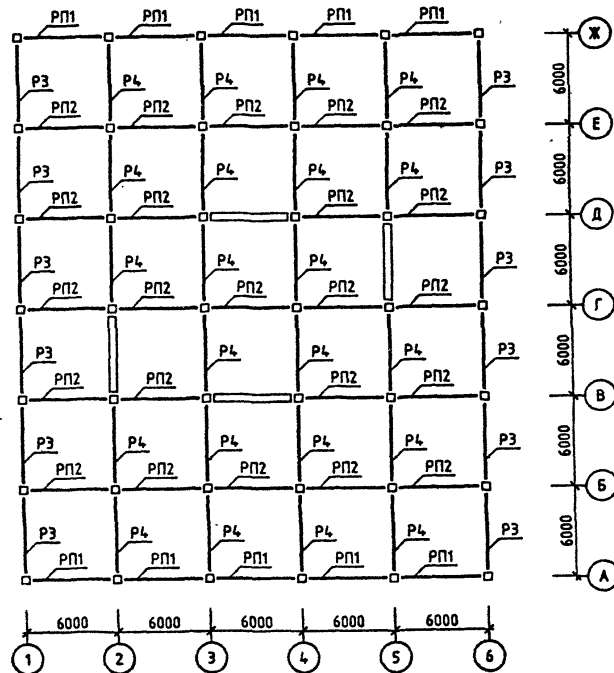

1.220.1-3М.0-1.4 2606

ЛИСТ
2

23171-04 105

ФОРМАТ А3

МОНТАЖНЫЙ ПЛАН РИГЕЛЕЙ И СВЯЗЕВЫХ ПЛИТ
ОТМ. +3.20 (+6.50)

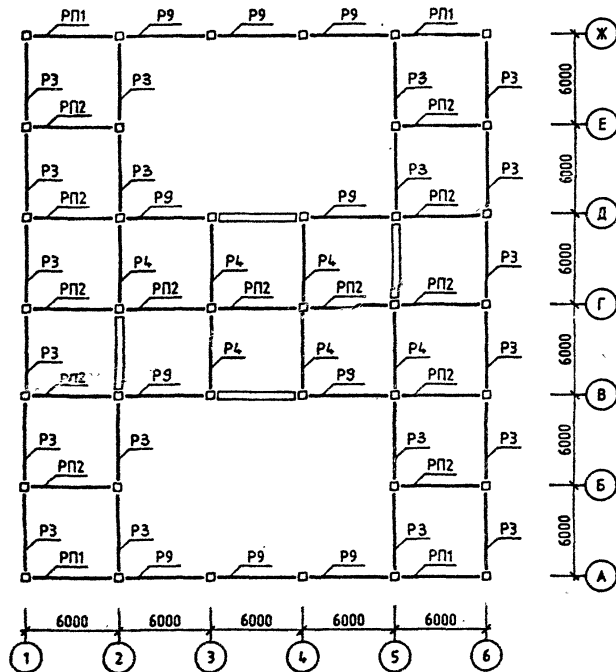

МОНТАЖНЫЙ ПЛАН РИГЕЛЕЙ И СВЯЗЕВЫХ ПЛИТ
ОТМ. +6.50 (+9.80)

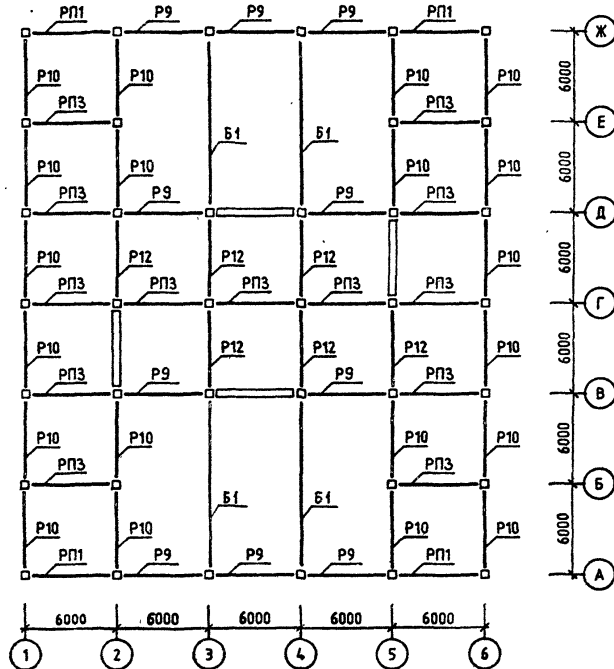

1.220.1-3М.0-1.4 26С6

ЛИСТ

3

Номер загрузки	Тип усилия	Номер группы элементов							
		1	2	3	4	5	6	7	8
ЯРУС 1 СЕЧЕНИЕ 1									
1	N	0.0	0.0	0.0	0.0	-23.7	-21.2	0.0	0.0
	MX	-6.0	-7.3	-10.2	-11.6	-24.3	-7.6	-4.7	-8.9
	MY	1.3	1.5	2.1	2.2	12.0	1.8	0.7	1.7
	QX	5.2	-8.6	-5.7	-9.0	11.3	19.2	4.0	5.8
		-0.9	-1.5	-0.8	-1.3	2.6	-6.4	-0.1	-0.1
8	N	0.0	0.0	0.0	0.0	0.1	-25.7	0.0	0.0
	MX	0.0	-0.1	0.1	0.1	-0.1	0.0	0.0	0.0
	MY	0.0	0.0	0.0	0.0	0.0	0.0	0.0	0.0
	QX	-0.8	-1.5	-1.3	-2.5	-3.2	-12.6	-1.1	-1.3
		-0.1	0.0	-0.2	-0.4	-0.7	-6.2	-0.2	-0.2
9	N	0.0	0.0	0.0	0.0	21.5	-0.1	0.0	0.0
	MX	0.7	1.3	1.2	2.1	10.6	2.7	0.9	0.6
	MY	-0.2	-0.2	-0.2	-0.4	-5.2	-0.6	-0.1	-0.1
	QX	0.0	0.0	0.0	0.0	0.0	0.0	0.0	0.0
		0.0	0.0	0.0	0.0	0.0	0.0	0.0	0.0
14	N	94.5	127.1	112.2	160.4	138.6	135.6	82.4	117.4
	MX	-0.7	0.4	1.4	0.5	3.6	0.2	0.0	3.0
	MY	0.4	-0.1	-0.9	-0.1	-2.5	-0.1	0.0	-1.4
	QX	-1.1	-1.8	-0.1	-0.1	-0.1	-3.8	0.0	0.0
		-0.7	-1.2	0.0	0.0	0.0	2.6	0.0	0.0
ЯРУС 1 СЕЧЕНИЕ 2									
1	N	0.0	0.0	0.0	0.0	23.7	21.2	0.0	0.0
	MX	0.7	1.4	1.9	2.7	-23.7	0.5	1.8	2.1
	MY	-1.3	-1.5	-2.1	-2.2	-12.0	-1.8	-0.7	-1.7
	QX	0.6	-1.9	1.1	2.1	0.8	19.2	-1.5	-1.2
		0.9	1.5	0.8	1.3	-2.6	6.4	0.1	0.1
8	N	0.0	0.0	0.0	0.0	-0.1	25.7	0.0	0.0
	MX	0.0	0.0	0.0	0.0	-0.1	0.0	0.0	0.0
	MY	0.0	0.0	0.0	0.0	0.0	0.0	0.0	0.0
	QX	0.2	0.5	0.4	0.6	0.4	-12.2	0.4	0.4
		0.1	0.3	0.2	0.4	0.7	6.1	0.2	0.2
9	N	0.0	0.0	0.0	0.0	-21.5	0.1	0.0	0.0
	MX	-0.1	-0.3	-0.3	-0.5	10.3	-0.3	-0.4	-0.5
	MY	0.1	0.2	0.2	0.4	5.2	0.6	0.1	0.0
	QX	0.0	0.0	0.0	0.0	0.0	0.0	0.0	0.0
		0.0	0.0	0.0	0.0	0.0	0.0	0.0	0.0
14	N	-94.5	-127.1	-112.2	-160.4	-138.6	-135.6	-82.4	-117.4
	MX	-1.0	0.1	2.3	0.0	6.3	0.2	0.0	-2.8
	MY	-0.4	0.1	0.9	-0.1	2.5	0.1	0.0	-1.4
	QX	-1.7	2.9	0.0	0.0	0.0	-6.9	0.0	0.0
		0.7	1.2	0.0	0.0	0.0	2.6	0.0	0.0
1.220.1-3M.0-1.4 26МУ1									
ГИП	Егунов								
Н.КОНТР.	Бойко								
РУК.ГР.	Рудашин								
ПРОВЕРИЛ	Футорная								
РАЗРАБ	Зуевко								
ЗДАНИЕ						СТАДИЯ	ЛИСТ	ЛИСТОВ	
3Т 6.5.30-ЗАЛ(2*12)40-4.0						Р	1	3	
ГОСГРАЖДАНСТРОЙ						КиевЗНИИЭП			

ФОРМАТ А4

Номер загрузки	Тип усилия	Номер группы элементов							
		1	2	3	4	5	6	7	8
ЯРУС 2 СЕЧЕНИЕ 1									
1	N	0.0	0.0	0.0	0.0	2.9	2.0	0.0	0.0
	MX	-3.7	-1.4	-1.9	-2.7	0.5	-0.7	-1.8	-2.1
	MY	1.3	1.5	2.1	2.2	-0.4	0.8	0.7	1.7
	QX	-0.6	1.9	-1.1	-2.1	1.1	-0.2	1.5	1.2
		-0.9	-1.5	-0.8	-1.3	1.2	0.2	-0.1	-0.1
8	N	0.0	0.0	0.0	0.0	0.0	-6.5	0.0	0.0
	MX	0.0	0.0	0.0	0.0	0.0	0.0	0.0	0.0
	MY	0.0	0.0	0.0	0.0	0.0	0.0	0.0	0.0
	QX	-0.2	-0.5	-0.4	-0.6	-0.3	0.0	-0.4	-0.4
		-0.1	-0.3	-0.2	-0.4	-0.3	0.0	-0.2	-0.2
9	N	0.0	0.0	0.0	0.0	-5.4	0.0	0.0	0.0
	MX	0.1	0.3	0.3	0.5	0.0	0.3	0.4	0.5
	MY	-0.1	-0.2	-0.2	-0.4	0.0	-0.3	-0.1	0.0
	QX	0.0	0.0	0.0	0.0	0.0	0.0	0.0	0.0
		0.0	0.0	0.0	0.0	0.0	0.0	0.0	0.0
14	N	67.0	93.2	79.5	122.1	55.9	54.1	44.1	84.7
	MX	-0.5	-0.1	-0.9	0.0	-0.6	0.1	0.0	0.5
	MY	0.4	-0.1	0.9	0.1	0.2	-0.1	0.0	-1.4
	QX	0.8	-1.4	0.0	0.0	0.0	0.7	0.0	0.0
		0.7	-1.2	0.0	0.0	0.0	0.3	0.0	0.0
ЯРУС 2 СЕЧЕНИЕ 2									
1	N	0.0	0.0	0.0	0.0	-2.9	-2.0	0.0	0.0
	MX	-2.5	-2.1	-3.0	-2.6	0.4	-1.2	0.0	-1.9
	MY	-1.3	-1.5	-2.1	-2.2	0.4	-0.8	0.7	-1.7
	QX	2.1	-2.5	-1.6	-1.9	1.8	-0.2	0.0	1.6
		0.9	1.5	0.8	1.3	-1.2	-0.2	-0.1	0.1
8	N	0.0	0.0	0.0	0.0	0.0	6.5	0.0	0.0
	MX	0.0	0.0	0.0	0.0	0.0	0.0	0.0	0.0
	MY	0.0	0.0	0.0	0.0	0.0	0.0	0.0	0.0
	QX	-0.2	0.4	-0.2	-0.5	-0.5	0.0	0.0	-0.2
		0.1	0.3	0.2	0.4	0.3	0.0	0.2	0.2
9	N	0.0	0.0	0.0	0.0	5.4	0.0	0.0	0.0
	MX	0.3	0.3	0.3	0.4	0.0	0.4	0.0	-0.5
	MY	0.2	0.2	0.2	0.4	0.0	0.3	0.1	0.0
	QX	0.0	0.0	0.0	0.0	0.0	0.0	0.0	0.0
		0.0	0.0	0.0	0.0	0.0	0.0	0.0	0.0
14	N	-67.0	-93.2	-79.5	-122.1	-55.9	-54.1	-44.1	-84.7
	MX	-0.7	0.3	1.3	0.3	-0.1	0.2	0.0	3.0
	MY	-0.4	0.1	0.9	0.1	0.2	0.1	0.0	1.4
	QX	-0.9	-1.6	-0.1	-0.1	0.0	0.1	0.0	0.0
		0.7	1.2	0.0	0.0	0.0	-0.3	0.0	0.0
1.220.1-3M.0-1.4 26МУ1									
									ЛИСТ
									2

23171-04 107

ФОРМАТ А4

Номер загрузки	Тип усилки	Номер группы элементов							
		1	2	3	4	5	6	7	8
ЯРУС 3 СЕЧЕНИЕ 1									
1	Н	0.0	0.0	0.0	0.0	1.6	1.6	0.0	0.0
	МХ	2.5	2.1	3.0	2.6	0.1	0.9	0.0	1.9
	МУ	-0.9	-0.8	-1.1	-0.9	-0.1	-0.4	0.0	-0.3
	ОХ	-2.1	2.5	1.6	1.9	-1.4	-0.1	0.0	-1.6
		0.6	0.8	0.4	0.6	-0.6	0.0	0.0	0.1
8	Н	0.0	0.0	0.0	0.0	0.0	-4.1	0.0	0.0
	МХ	0.0	0.0	0.0	0.0	0.0	0.0	0.0	0.0
	МУ	0.0	0.0	0.0	0.0	0.0	0.0	0.0	0.0
	ОХ	0.2	-0.4	0.2	0.5	0.4	-0.1	0.0	0.2
		0.0	0.1	0.0	0.1	0.1	-0.1	0.0	0.0
9	Н	0.0	0.0	0.0	0.0	-3.5	0.0	0.0	0.0
	МХ	-0.3	-0.3	-0.3	-0.4	0.1	-0.3	0.0	-0.5
	МУ	0.1	0.1	0.1	0.2	-0.1	0.1	0.0	-0.5
	ОХ	0.6	0.0	0.0	0.0	0.0	0.0	0.0	0.0
		0.0	0.0	0.0	0.0	0.0	0.0	0.0	0.0
14	Н	44.3	60.9	48.4	78.0	22.6	19.0	0.0	53.6
	МХ	-0.4	-0.3	-0.7	-0.3	-0.5	-0.2	0.0	-1.0
	МУ	0.3	0.5	0.2	0.5	0.4	0.2	0.0	1.2
	ОХ	1.0	-2.3	0.1	0.1	0.0	0.3	0.0	0.0
		0.5	-0.7	0.1	0.0	0.0	-0.2	0.0	0.0
ЯРУС 3 СЕЧЕНИЕ 2									
1	Н	0.0	0.0	0.0	0.0	-1.6	-1.6	0.0	0.0
	МХ	-0.5	-0.4	0.6	-0.5	0.1	0.4	0.0	-1.0
	МУ	-0.8	-0.6	1.1	-0.9	0.1	0.4	0.0	0.3
	ОХ	-0.4	0.8	0.2	-0.4	-0.5	-0.1	0.0	-0.2
		-0.7	-0.9	-0.4	0.6	0.6	0.0	0.0	-0.1
8	Н	0.0	0.0	0.0	0.0	0.0	4.1	0.0	0.0
	МХ	0.1	0.1	-0.1	-0.1	0.0	0.0	0.0	0.0
	МУ	0.0	0.0	0.0	0.0	0.0	0.0	0.0	0.0
	ОХ	-0.2	-1.2	-0.1	0.1	0.2	-0.1	0.0	-0.2
		0.0	0.5	0.0	-0.1	0.1	0.0	0.0	0.0
9	Н	0.0	0.0	0.0	0.0	3.5	0.0	0.0	0.0
	МХ	-0.1	-0.1	-0.1	-0.1	0.1	-0.1	0.0	1.2
	МУ	0.0	0.0	0.0	0.0	0.0	0.0	0.0	0.5
	ОХ	0.0	0.0	0.0	0.0	0.0	0.0	0.0	0.0
		0.0	0.0	0.0	0.0	0.0	0.0	0.0	0.0
14	Н	-44.3	-60.9	-48.4	-78.0	-22.6	-19.0	0.0	-53.6
	МХ	0.9	-1.4	0.1	1.3	-0.7	-0.5	0.0	3.0
	МУ	0.2	-0.5	-0.2	0.5	-0.4	-0.2	0.0	1.2
	ОХ	0.7	-2.3	0.1	0.1	0.1	0.4	0.0	0.1
		0.5	0.7	-0.1	0.0	0.0	0.2	0.0	0.0

1.220.1-3М.0-1.4 26МУ/ ЛИСТ
3

Номер загрузки	Тип усилки	Номер группы элементов							
		1	2	3	4	5	6	7	8
ЯРУС 1 СЕЧЕНИЕ 1									
1	Н	0.0	0.0	0.0	0.0	-23.7	-21.1	0.0	0.0
	МХ	-6.0	-7.2	-10.2	-11.6	-24.1	-7.4	-6.5	-9.8
	МУ	1.3	1.5	2.1	2.2	11.9	1.7	1.3	2.0
	ОХ	5.2	8.7	-5.8	-9.1	11.3	19.0	5.4	5.8
		-0.9	-1.5	-0.8	-1.3	2.6	-6.5	-0.2	-0.1
8	Н	0.0	0.0	0.0	0.0	0.1	-40.3	0.0	0.0
	МХ	0.0	0.0	0.0	0.0	0.1	0.0	0.0	0.0
	МУ	0.0	0.0	0.0	0.0	0.0	0.0	0.0	0.0
	ОХ	-1.0	-2.0	-1.8	-3.1	-4.0	-16.0	-1.8	-1.8
		-0.2	-0.4	-0.3	-0.6	-0.9	-7.9	-0.3	-0.3
9	Н	0.0	0.0	0.0	0.0	-33.8	0.0	0.0	0.0
	МХ	-0.9	1.5	1.5	2.6	13.4	3.3	1.5	1.7
	МУ	-0.2	-0.3	-0.3	-0.5	-6.7	-0.7	-0.3	-0.4
	ОХ	0.0	0.0	0.0	0.0	0.0	0.0	0.0	0.0
		0.0	0.0	0.0	0.0	0.0	0.0	0.0	0.0
14	Н	117.1	159.4	143.3	204.5	172.8	170.3	126.5	148.5
	МХ	0.5	-0.1	1.1	-0.1	-5.4	0.0	0.0	-0.7
	МУ	-0.4	0.0	-0.8	0.0	3.7	0.0	0.0	0.7
	ОХ	1.1	-1.9	0.0	0.0	0.0	5.7	0.0	0.0
		0.7	-1.1	0.0	0.0	0.0	4.0	0.0	0.0
ЯРУС 1 СЕЧЕНИЕ 2									
1	Н	0.0	0.0	0.0	0.0	23.7	21.1	0.0	0.0
	МХ	0.7	1.4	1.9	2.7	-23.6	0.5	1.3	1.9
	МУ	-1.3	-1.5	-2.1	-2.2	-11.9	-1.7	-1.3	-2.0
	ОХ	-0.6	-1.7	1.1	2.1	-0.8	19.1	-1.1	-1.1
		0.9	1.5	0.8	1.3	-2.6	6.5	0.2	0.1
8	Н	0.0	0.0	0.0	0.0	-0.1	40.3	0.0	0.0
	МХ	0.0	0.0	0.0	0.0	0.1	0.0	0.0	0.0
	МУ	0.0	0.0	0.0	0.0	0.0	0.0	0.0	0.0
	ОХ	0.2	0.4	0.4	0.8	0.5	-15.9	0.4	0.4
		0.2	0.4	0.3	0.6	0.9	8.0	0.3	0.3
9	Н	0.0	0.0	0.0	0.0	33.8	0.0	0.0	0.0
	МХ	-0.1	-0.3	-0.3	-0.6	13.3	-0.5	-0.3	-0.3
	МУ	0.2	0.3	0.3	0.5	6.7	0.7	0.3	0.3
	ОХ	0.0	0.0	0.0	0.0	0.0	0.0	0.0	0.0
		0.0	0.0	0.0	0.0	0.0	0.0	0.0	0.0
14	Н	-117.1	-159.4	-143.3	-204.5	-172.8	-170.3	-126.5	-148.5
	МХ	0.9	0.0	2.2	0.0	9.6	0.0	0.0	2.1
	МУ	0.4	0.0	0.8	0.0	3.7	0.0	0.0	0.7
	ОХ	1.7	-2.9	0.0	0.0	0.0	10.2	0.0	0.0
		-0.7	1.1	0.0	0.0	0.0	3.9	0.0	0.0

Безудова
ОПЕРАТОР СИСТЕМЫ
САПР
КиевЗНИИЭП

ПОДПИСЬ И ДАТА
ВЗАМ ИНВ.М

1.220.1-3М.0-1.4 26МУ2

ИНВ № ПОДЛ	ГИП	Егузов	СТАДИЯ	ЛИСТ	ЛИСТОВ
	НКОНТР.	Бойко		Р	1
	РУК.ГР.	Рудавки	ГОСГРАЖДАНСТРОЙ		
	ПРОВЕРИЛ	Футормая	КиевЗНИИЭП		
	РАЗРАБ	Зуенко	ЗДАНИЕ 4Т 6.5.30-ЗАЛ(2*12)40-4.0		

Номер загрузки	Тип усилия	Номер группы элементов							
		1	2	3	4	5	6	7	8
ЯРУС 2 СЕЧЕНИЕ 1									
1	N	0.0	0.0	0.0	0.0	2.8	1.9	0.0	0.0
	MX	-0.7	-1.4	-1.9	-2.7	0.5	-0.7	-1.3	-1.9
	QY	1.3	1.5	2.1	2.2	-0.4	0.8	1.3	2.0
	MU	0.6	1.7	-1.1	-2.1	1.1	-0.2	1.1	1.1
	QX	-0.9	-1.5	-0.8	-1.3	1.2	0.2	-0.2	-0.1
8	N	0.0	0.0	0.0	0.0	0.0	13.4	0.0	0.0
	MX	0.0	0.0	0.0	0.0	0.0	0.0	0.0	0.0
	QY	0.0	0.0	0.0	0.0	0.0	0.0	0.0	0.0
	MU	-0.2	-0.4	-0.4	-0.8	-0.4	-0.3	-0.4	-0.4
	QX	-0.2	-0.4	-0.3	-0.6	-0.4	-0.2	-0.3	-0.3
9	N	0.0	0.0	0.0	0.0	-11.3	0.0	0.0	0.0
	MX	0.1	0.3	0.3	0.6	0.2	0.3	0.3	0.3
	QY	-0.2	-0.3	-0.3	-0.5	-0.2	-0.3	-0.3	-0.3
	MU	0.0	0.0	0.0	0.0	0.0	0.0	0.0	0.0
	QX	0.0	0.0	0.0	0.0	0.0	0.0	0.0	0.0
14	N	89.6	125.4	110.5	166.2	72.9	71.8	88.2	115.7
	MX	-0.5	0.0	-1.0	0.0	-1.0	0.0	0.0	-1.1
	QY	0.4	0.0	0.8	0.0	0.6	0.0	0.0	0.7
	MU	-0.8	1.2	0.0	0.0	0.0	-1.1	0.0	0.0
	QX	-0.7	-1.1	0.0	0.0	0.0	0.6	0.0	0.0
ЯРУС 2 СЕЧЕНИЕ 2									
1	N	0.0	0.0	0.0	0.0	-2.8	-1.9	0.0	0.0
	MX	-2.5	-2.1	-3.0	-2.6	0.4	-1.2	-1.8	-2.9
	QY	-1.3	-1.5	-2.1	-2.2	0.4	-0.8	-1.3	-2.0
	MU	2.1	-2.5	-1.6	-2.0	1.8	-0.2	1.5	1.7
	QX	0.9	1.5	0.8	1.3	-1.2	-0.2	0.2	0.1
8	N	0.0	0.0	0.0	0.0	0.0	-13.4	0.0	0.0
	MX	0.0	0.0	0.0	0.0	0.0	0.0	0.0	0.0
	QY	0.0	0.0	0.0	0.0	0.0	0.0	0.0	0.0
	MU	-0.3	-0.6	-0.4	-0.6	-0.5	-0.2	-0.4	-0.4
	QX	0.2	0.4	0.3	0.6	0.4	0.2	0.3	0.3
9	N	0.0	0.0	0.0	0.0	11.3	0.0	0.0	0.0
	MX	0.3	0.4	0.4	0.5	0.2	0.4	0.4	0.5
	QY	0.2	0.3	0.3	0.5	0.2	0.3	0.3	0.4
	MU	0.0	0.0	0.0	0.0	0.0	0.0	0.0	0.0
	QX	0.0	0.0	0.0	0.0	0.0	0.0	0.0	0.0
14	N	-89.6	-125.4	-110.5	-166.2	-72.9	-71.8	-88.2	-115.7
	MX	0.4	-0.1	1.0	0.1	-0.3	0.0	0.0	-0.6
	QY	0.4	0.0	0.8	0.0	-0.6	0.0	0.0	-0.7
	MU	0.9	-1.7	0.0	0.0	0.0	-0.4	0.0	0.0
	QX	-0.7	1.1	0.0	0.0	0.0	0.6	0.0	0.0

Всех
Шеишисеши

1.220.1-3M.0-1.4 26МУ2

ЛИСТ
2

ФОРМАТ А4

Номер загрузки	Тип усилия	Номер группы элементов							
		1	2	3	4	5	6	7	8
ЯРУС 3 СЕЧЕНИЕ 1									
1	N	0.0	0.0	0.0	0.0	1.7	1.5	0.0	0.0
	MX	2.5	2.1	3.0	2.6	0.1	0.9	1.8	2.9
	QY	-0.9	-0.8	-1.1	-1.0	-0.1	-0.4	-0.6	-1.0
	MU	-2.1	2.5	1.6	2.0	-1.4	-0.1	-1.5	-1.7
	QX	0.7	0.8	0.4	0.6	-0.6	0.0	0.1	0.1
8	N	0.0	0.0	0.0	0.0	0.0	-8.8	0.0	0.0
	MX	0.0	0.0	0.0	0.0	0.0	0.0	0.0	0.0
	QY	0.0	0.0	0.0	0.0	0.0	0.0	0.0	0.0
	MU	0.3	0.6	0.4	0.6	0.4	-0.2	0.4	0.4
	QX	0.1	0.4	0.2	0.2	0.2	-0.1	0.1	0.2
9	N	0.0	0.0	0.0	0.0	-7.4	0.0	0.0	0.0
	MX	-0.3	-0.4	-0.4	-0.5	0.2	-0.3	-0.4	-0.5
	QY	0.1	0.1	0.1	0.2	-0.1	0.1	0.1	0.4
	MU	0.0	0.0	0.0	0.0	0.0	0.0	0.0	0.0
	QX	0.0	0.0	0.0	0.0	0.0	0.0	0.0	0.0
14	N	67.0	93.2	79.5	122.1	31.1	29.6	44.1	84.7
	MX	-0.4	0.1	-1.0	-0.1	-0.3	0.1	0.0	-1.4
	QY	0.4	-0.1	0.7	0.1	0.2	-0.1	0.0	1.3
	MU	-1.0	-1.6	0.0	0.0	0.0	-0.2	0.0	0.0
	QX	-0.6	-1.0	0.0	0.0	0.0	-0.2	0.0	0.0
ЯРУС 3 СЕЧЕНИЕ 2									
1	N	0.0	0.0	0.0	0.0	-1.7	-1.5	0.0	0.0
	MX	-0.5	0.4	-0.7	0.6	0.1	0.3	0.0	0.4
	QY	-0.8	0.8	-1.0	1.0	0.1	0.4	-0.5	1.0
	MU	-0.4	-0.6	0.3	0.4	-0.5	-0.1	0.0	-0.3
	QX	-0.8	-0.8	-0.6	-0.6	0.6	0.0	-0.2	-0.1
8	N	0.0	0.0	0.0	0.0	0.0	8.8	0.0	0.0
	MX	-0.1	0.0	0.0	0.0	0.0	0.0	0.0	0.0
	QY	0.0	0.0	0.0	0.0	0.0	0.0	0.0	0.0
	MU	0.1	0.8	0.1	0.2	0.2	-0.2	0.0	0.1
	QX	-0.1	-0.4	-0.2	-0.2	-0.2	0.1	-0.1	-0.2
9	N	0.0	0.0	0.0	0.0	7.4	0.0	0.0	0.0
	MX	-0.1	-0.1	-0.1	-0.1	0.1	-0.1	0.0	-0.8
	QY	-0.1	-0.1	-0.1	-0.2	0.1	-0.1	-0.1	-0.4
	MU	0.0	0.0	0.0	0.0	0.0	0.0	0.0	0.0
	QX	0.0	0.0	0.0	0.0	0.0	0.0	0.0	0.0
14	N	-67.0	-93.2	-79.5	-122.1	-31.1	-29.6	-44.1	-84.7
	MX	-0.7	0.4	1.2	0.3	-0.5	0.2	0.0	3.0
	QY	-0.4	0.1	0.7	0.1	-0.2	0.1	0.0	1.3
	MU	-1.0	-1.7	-0.1	-0.1	0.0	-0.4	0.0	0.0
	QX	0.6	1.0	0.0	0.0	0.0	0.2	0.0	0.0

Безудова
ОПЕРАТОР СИСТЕМЫ
САПР
КиевЗНИИЭП

ИНВ № ПОДП
ПОДПИСЬ И ДАТА
ВЗАМ. ИНВ №

1.220.1-3M.0-1.4 26МУ2

ЛИСТ
3

23171-04 109

ФОРМАТ А4

МАРКА ПОЗ	ОБОЗНАЧЕНИЕ	НАИМЕНОВАНИЕ	КОП.	МАССА ЕД. КГ	ПРИМЕЧАНИЕ
		ДОКУМЕНТАЦИЯ			
A3	I.220.I-3M.0-I.4 00T0	ТЕХНИЧЕСКОЕ ОПИСАНИЕ СБОРОЧНЫЕ ЕДИНИЦЫ РИТЕЛЬ			
PI	I.220.I-3M.3-I 03-02	РДП.53-50	8	2518	
P2	I.220.I-3M.3-I 01-01	РДП.53-90ATY	22	2518	
P9	I.220.I-3M.3-I 09	Р4.57-20	14	1710	
PI0	I.020-I/83.3-I 07-01	РОП 4.57-30	14	2070	
PI3	I.020-I/83.3-I 02-02	РДП 4.57-60ATY	4	2600	
PI3	I.04I.I-2.I.400-01	СВЯЗЕВАЯ ПЛИТА ПК56.15-6ATLYC(ALY)T-2	9	2600	
	ПЕРЕМЕННЫЕ ДАННЫЕ	ДЛЯ ИСПОЛНЕНИЯ I.220.I-3M.0-I.4 27 3T 4.7.30-3AL(24) 32-3.5			
		РОСТВЕРК			
Φ1	I.220.I-3M.I-I 04	2Φ3-32	4	4275	
Φ2	I.220.I-3M.I-I 03	1Φ3-32	14	4390	
Φ3	I.220.I-3M.I-I 02	Φ2-32	9	2650	
Φ4	I.220.I-3M.I-I 03	1Φ3-32	5	4390	
Φ6		ΦД9-32	2		
Φ12		1ΦД9-32	2		
		КОЛОННА			
K1	I.220.I-3M.2-I I3	КОЗТ 3.33-25.2	4	2373	
K2	I.220.I-3M.2-I I7-02	КОФЗТ 3.33-40.7	2	2414	
K3	I.220.I-3M.2-I II-01	КДЗТ 3.33-25.3	6	2496	
K4	I.220.I-3M.2-I II-01	КДЗТ 3.33-25.3	3	2496	
K5	I.220.I-3M.2-I I3	КОЗТ 3.33-25.2	4	2373	
K6	I.220.I-3M.2-I II-01	КДЗТ 3.33-25.3	2	2496	
K7	I.220.I-3M.2-I I3	КОЗТ 3.33-25.2	4	2373	
K8	I.220.I-3M.2-I 09	КДТ 3.33-25.1	9	776	
		I.220.I-3M.0-I.4 27			
НАЧ ОТД	Шевченко	ЗДАНИЕ 3T 4.7-3AL(24) 4T 4.7-3AL(24)	СТАДИЯ	ЛИСТ	ЛИСТОВ
И.КОНТР.	Егоров		Р	1	4
ГЛ СПЕЦ.	Рудавин		ГОСГРАЖДАНСТРОЙ		
ПРОВЕРИЛ	Зуенко		КиевЗНИИЭП		
РАЗРАБ.	Безгудова				

МАРКА ПОЗ	ОБОЗНАЧЕНИЕ	НАИМЕНОВАНИЕ	КОП.	МАССА ЕД. КГ	ПРИМЕЧАНИЕ
K9	I.220.I-3M.2-I I3	КОЗТ 3.33-25.2	2	2373	
K10	I.220.I-3M.2-I I7-02	КОФЗТ 3.33-40.7	4	2414	
		РИТЕЛЬ			
P3	I.020-I/83.3-I 07-02	РОП 4.57-40	22	2070	
P4	I.020-I/83.3-I 02-03	РДП 4.57-70ATY	26	2600	
		СВЯЗЕВАЯ ПЛИТА			
PPI	I.04I.I-2.I.200-01	ПК56.12-8ATLYC(ALY)T-I	24	2000	
PPI2	I.04I.I-2.I.400-02	ПК56.15-8ATLYC(ALY)T-2	30	2600	
		I.220.I-3M.0-I.4 27-01 3T 4.7.30-3AL(24) 40-2.5			
		РОСТВЕРК			
Φ1	I.220.I-3M.I-I 04-01	2Φ3-40	4	3625	
Φ2	I.220.I-3M.I-I 03-01	1Φ3-40	14	3755	
Φ3	I.220.I-3M.I-I 02-01	Φ2-40	9	2575	
Φ4	I.220.I-3M.I-I 03-01	1Φ3-40	5	3755	
Φ6		ΦД9-32	2		
Φ12		1ΦД9-40	2		
		КОЛОННА			
K1	I.220.I-3M.2-I I3-01	КОЗТ 3.33-25.3	4	2428	
K2	I.220.I-3M.2-I I7-02	КОФЗТ 3.33-40.7	2	2414	
K3	I.220.I-3M.2-I II-04	КДЗТ 3.33-30.3	6	2496	
K4	I.220.I-3M.2-I I2	КДЗТ 3.33-40.4	3	2970	
K5	I.220.I-3M.2-I I3-01	КОЗТ 3.33-25.3	4	2428	
K6	I.220.I-3M.2-I I2	КДЗТ 3.33-40.4	2	2970	
K7	I.220.I-3M.2-I I3	КОЗТ 3.33-25.2	4	2373	
K8	I.220.I-3M.2-I 09	КДТ 3.33-25.1	9	776	
K9	I.220.I-3M.2-I I3-01	КОЗТ 3.33-25.3	2	2428	
K10	I.220.I-3M.2-I I7-02	КОФЗТ 3.33-40.7	4	2414	
		РИТЕЛЬ			
P3	I.020-I/83.3-I 07-02	РОП 4.57-40	22	2070	
P4	I.020-I/83.3-I 02-03	РДП 4.57-70ATY	26	2600	
		I.220.I-3M.0-I.4 27			

САПР
КиевЗНИИЭП
ОПЕРАТОР
СИСТЕМЫ

ИВН № ПОДП
ПОДПИСЬ И ДАТА
БЕЛАН ИВН №

23171-04 111

ЛИСТ
2

МАРКА ПОЗ	ОБОЗНАЧЕНИЕ	НАИМЕНОВАНИЕ	КОП	МАССА ЕД КГ	ПРИМЕЧАНИЕ
РП1 РП2	I.04I.I-2.I.200-01	СВЯЗЕВАЯ ПЛИТА ПК56.12-8ATIYC(ALV)T-I	24	2000	
	I.04I.I-2.I.400-02	ПК56.15-8ATIYC(ALV)T-2	30	2600	
		I.220.I-3M.O-I.4 27-02 4T 4.7.30-3AJI(24) 32-3.5			
		РОСТБЕРК			
Φ1	I.220.I-3M.I-I 04	2Φ3-32	4	4275	
Φ2	I.220.I-3M.I I 03	IΦ3-32	14	4390	
Φ3	I.220.I-3M.I-I 02	Φ2-32	9	2650	
Φ4	I.220.I-3M.I-I 05	Φ4-32	5	4775	
Φ6		ΦД9-40	2		
Φ12		IΦД11-32	2		
		КОЛОННА			
K1	I.220.I-3M.2-I 18	КО4Т 3.33-30.2	4	3179	
K2	I.220.I-3M.2-I 24-03	КОФ4Т 3.33-40.7	2	3248	
K3	I.220.I-3M.2-I 18-04	КД4Т 3.33-40.2	6	3269	
K4	I.220.I-3M.2-I 18-04	КД4Т 3.33-40.2	3	3269	
K5	I.220.I-3M.2-I 18	КО4Т 3.33-30.2	4	3179	
K6	I.220.I-3M.2-I 18-04	КД4Т 3.33-40.2	2	3269	
K7	I.220.I-3M.2-I 18	КО4Т 3.33-30.2	4	3179	
K8	I.220.I-3M.2-I 10	КД2Т 3.33-25.1	9	1592	
K9	I.220.I-3M.2-I 18	КО4Т 3.33-30.2	2	3179	
K10	I.220.I-3M.2-I 24-03	КОФ4Т 3.33-40.7	4	3248	
		РИТЕЛЬ			
P3	I.020-I/83.3-I 07-02	РОП 4.57-40ATY	30	2070	
P4	I.020-I/83.3-I 02-03	РДП 4.57-70ATY	48	2600	
		СВЯЗЕВАЯ ПЛИТА			
РП1 РП2	I.04I.I-2.I.200-01	ПК56.12-8ATIYC(ALV)T-I	36	2000	
	I.04I.I-2.I.400-02	ПК56.15-8ATIYC(ALV)T-2	51	2600	
I.220.I-3M.O-I.4 27					ЛИСТ 3

ФОРМАТ А4

МАРКА ПОЗ	ОБОЗНАЧЕНИЕ	НАИМЕНОВАНИЕ	КОП	МАССА ЕД КГ	ПРИМЕЧАНИЕ
		I.220.I-3M.O-I.4 27-03 4T 4.7.30-3AJI(24) 40-4.0			
		РОСТБЕРК			
Φ1	I.220.I-3M.I-I 04-01	2Φ3-40	4	3625	
Φ2	I.220.I-3M.I-I 03-01	IΦ3-40	14	3755	
Φ3	I.220.I-3M.I-I 02-01	Φ2-40	9	2575	
Φ4	I.220.I-3M.I-I 05-01	Φ4-40	5	4100	
Φ6		ΦД9-40	2		
Φ12		IΦД11-40	2		
		КОЛОННА			
K1	I.220.I-3M.2-I 18	КО4Т 3.33-30.2	4	3179	
K2	I.220.I-3M.2-I 24-03	КОФ4Т 3.33-40.7	2	3248	
K3	I.220.I-3M.2-I 18-04	КД4Т 3.33-40.2	6	3269	
K4	I.220.I-3M.2-I 18-05	КД4Т 3.33-40.3	3	3343	
K5	I.220.I-3M.2-I 18	КО4Т 3.33-30.2	4	3179	
K6	I.220.I-3M.2-I 18-05	КД4Т 3.33-40.3	2	3343	
K7	I.220.I-3M.2-I 18	КО4Т 3.33-30.2	4	3179	
K8	I.220.I-3M.2-I 10	КД2Т 3.33-25.1	9	1592	
K9	I.220.I-3M.2-I 18	КО4Т 3.33-30.2	2	3179	
K10	I.220.I-3M.2-I 24-03	КО4Т 3.33-40.7	4	3248	
		РИТЕЛЬ			
P3	I.020-I/83.3-I 07-02	РОП 4.57-40ATY	30	2070	
P4	I.020-I/83.3-I 02-03	РДП 4.57-70ATY	48	2600	
		СВЯЗЕВАЯ ПЛИТА			
РП1 РП2	I.04I.I-2.I.200-01	ПК56.12-8ATIYC(ALV)T-I	36	2000	
	I.04I.I-2.I.400-02	ПК56.15-8ATIYC(ALV)T-2	51	2600	
I.220.I-3M.O-I.4 27					ЛИСТ 4

23171-04 112 ФОРМАТ А4

КиевЗНИИЭП

МОНТАЖНЫЙ ПЛАН РОСТВЕРКОВ

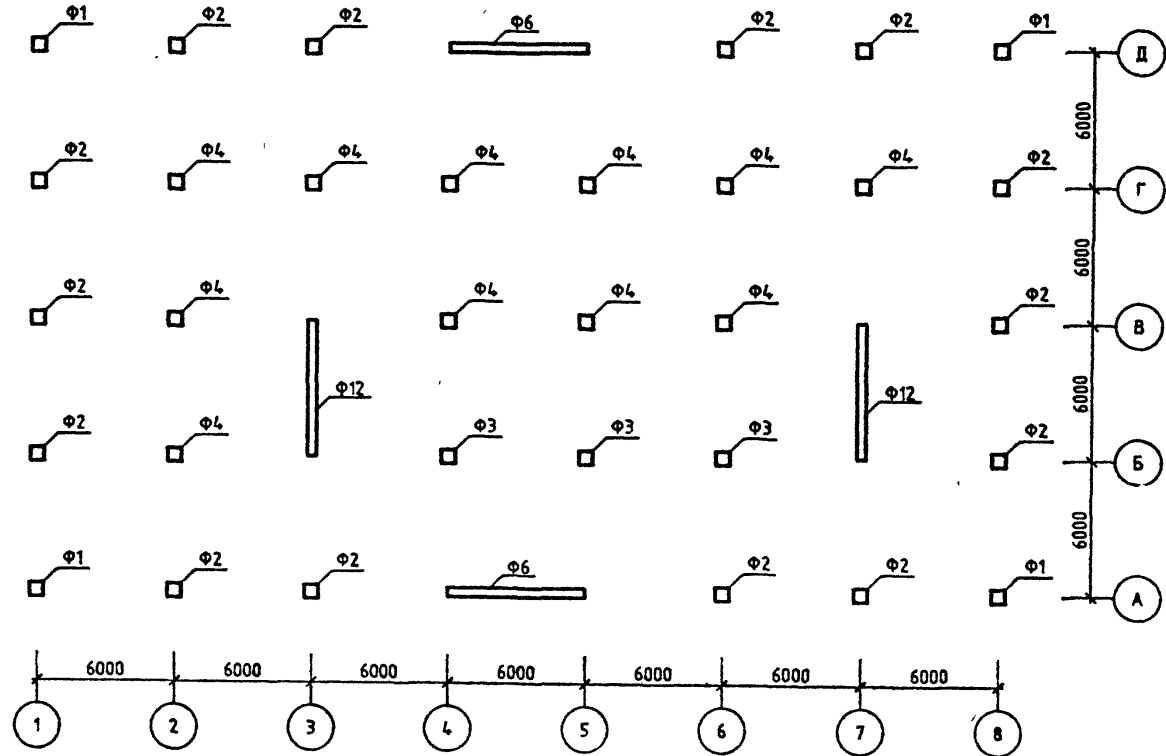

ОБОЗНАЧЕНИЕ	ШИФР ЗДАНИЯ
1.220.1-ЗМ.0-1.4 27	ЭТ 4.7.30-ЗАЛ(24)32-3.5
-01	ЭТ 4.7.30-ЗАЛ(24)40-2.5
-02	4Т 4.7.30-ЗАЛ(24)32-3.5
-03	4Т 4.7.30-ЗАЛ(24)40-2.5

1.220.1-ЗМ.0-1.4 27СБ				
ЗДАНИЕ		СТАДИЯ	ЛИСТ	ЛИСТОВ
ЭТ 4.7-ЗАЛ(24) 4Т 4.7-ЗАЛ(24)		Р	1	6
Нач. отд	Шевченко	ГОСГРАЖДАНСТРОЙ		
ГИП	Егузов	КиевЗНИИЭП		
Н.КОНТР.	Зуевко			
ПРОВЕРИЛ	Бояко			
РАЗРАБ	Рудавки			

23171-04 113

МОНТАЖНЫЙ ПЛАН КОЛОНН

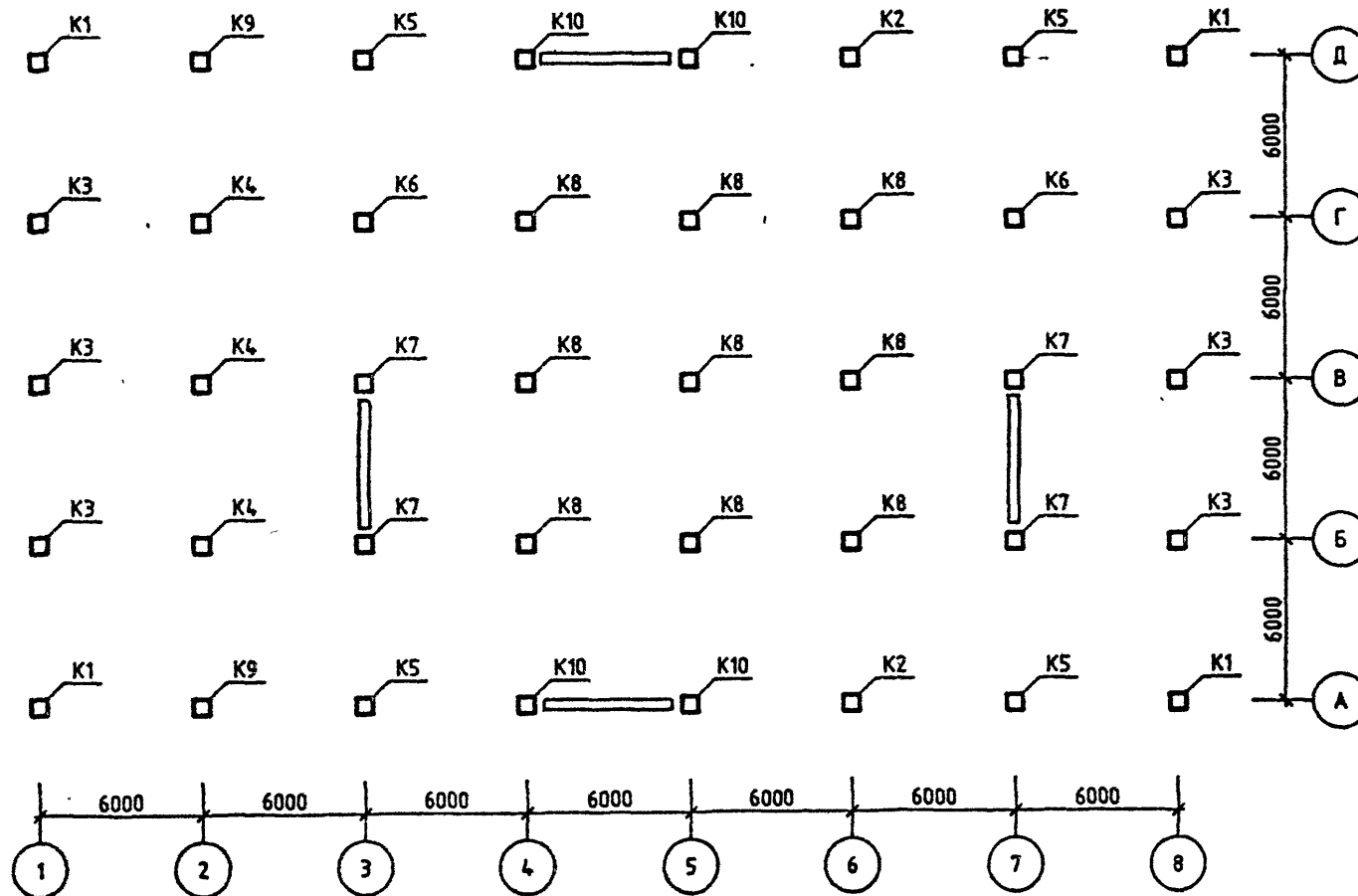

1.220.1-3М.0-1.4 27СБ

ЛИСТ

2

23171-04 114 ФОРМАТ А3

КиевЭНИИЭП

МОНТАЖНЫЙ ПЛАН РИГЕЛЕЙ

ОТМ. -2.32

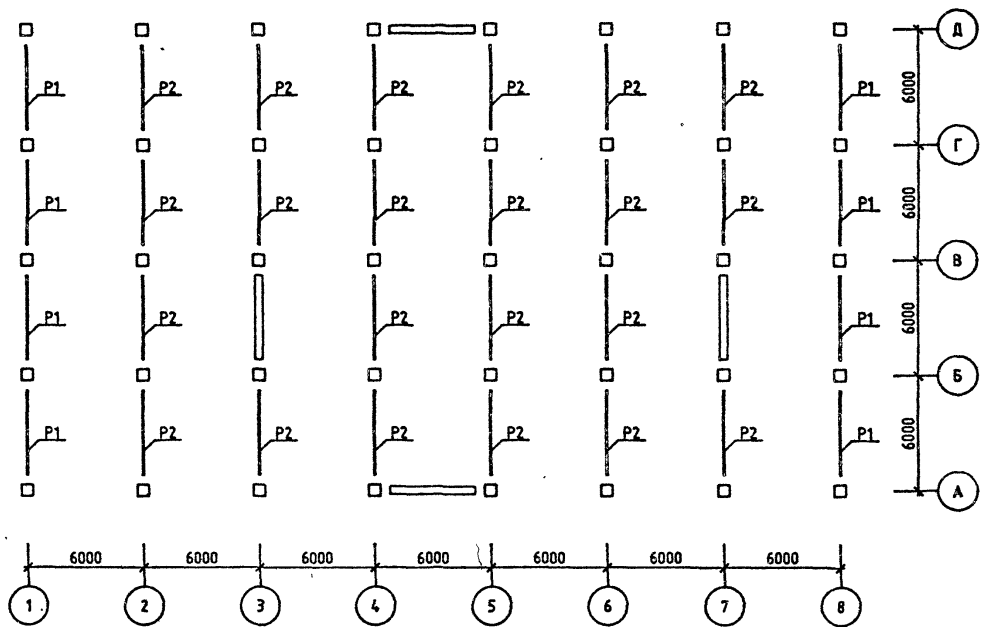

1.220.1-3М.0-1.4 2706

ЛИСТ
3

23171-04 115 ФОРМАТ А3

МОНТАЖНЫЙ ПЛАН РИГЕЛЕЙ И СВЯЗЕВЫХ ПЛИТ

ОТМ. -0.10 (+3.20)

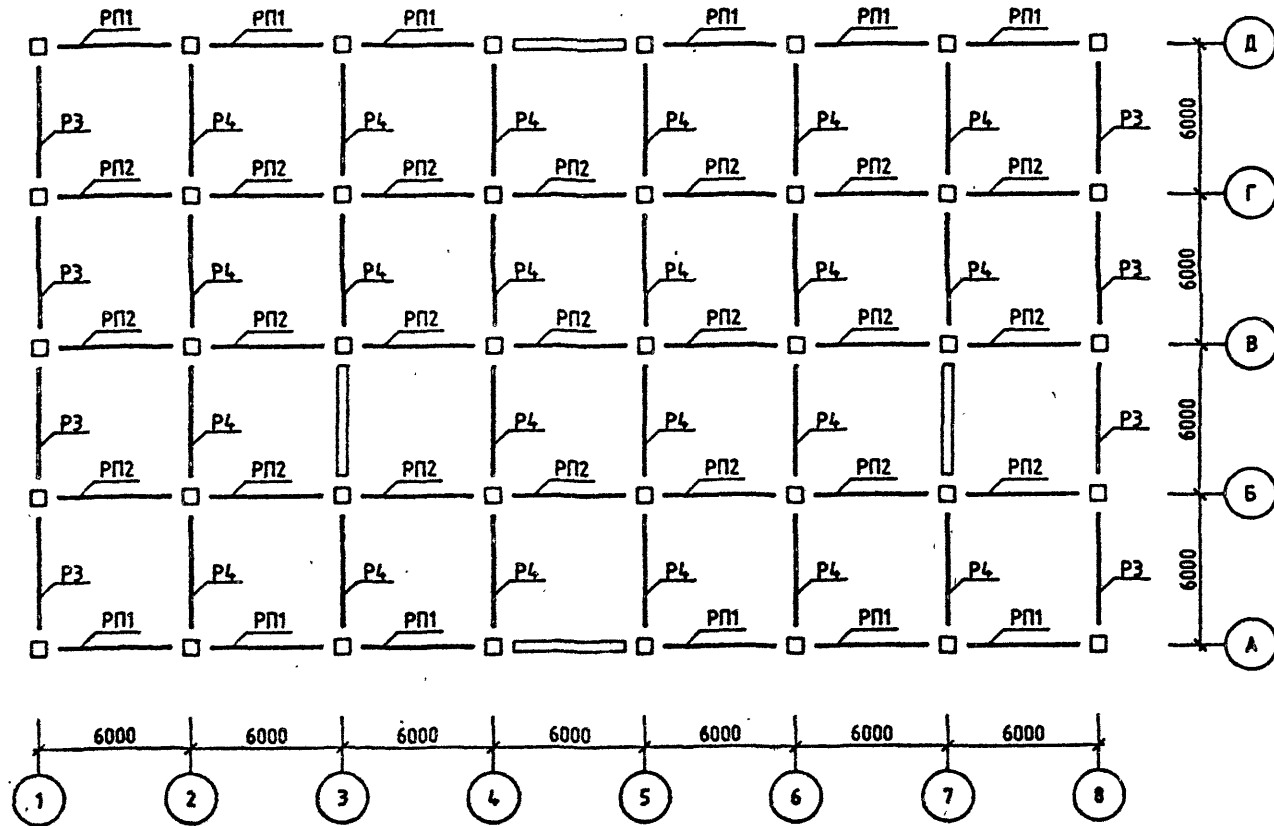

1.220.1-3М.0-1.4 27СБ

ЛИСТ

4

23171-04 116

ФОРМАТ А3

МОНТАЖНЫЙ ПЛАН РИГЕЛЕЙ И СВЯЗЕВЫХ ПЛИТ

ОТМ. +3.20 (+6.50)

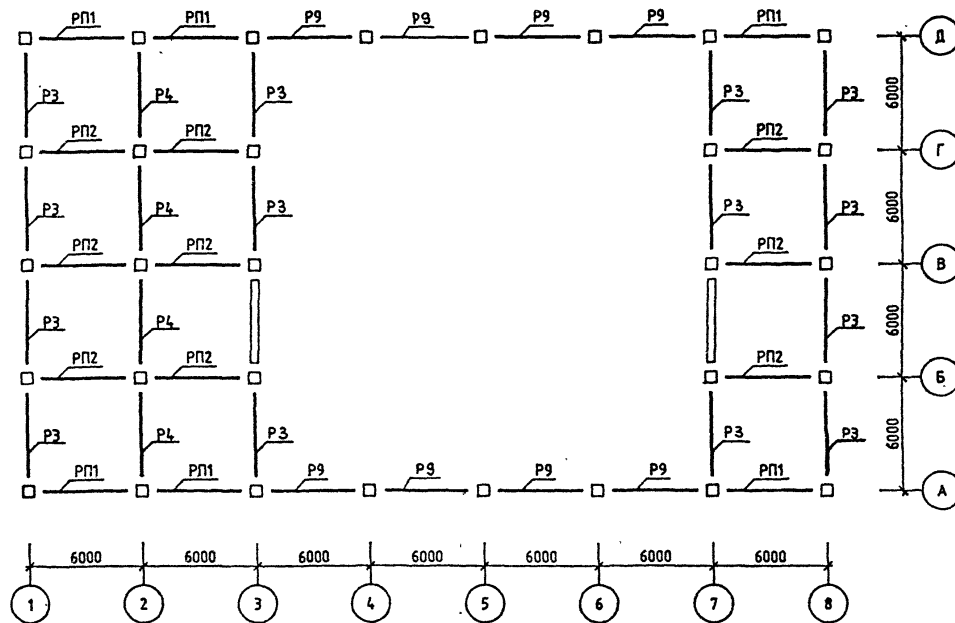

1.220.1-3М.0-1.4 270Б

ЛИСТ
5

23171-04 117 ФОРМАТ А3

МОНТАЖНЫЙ ПЛАН РИГЕЛЕЙ И СВЯЗЕВЫХ ПЛИТ

ОТМ. +6.50 (+9.80)

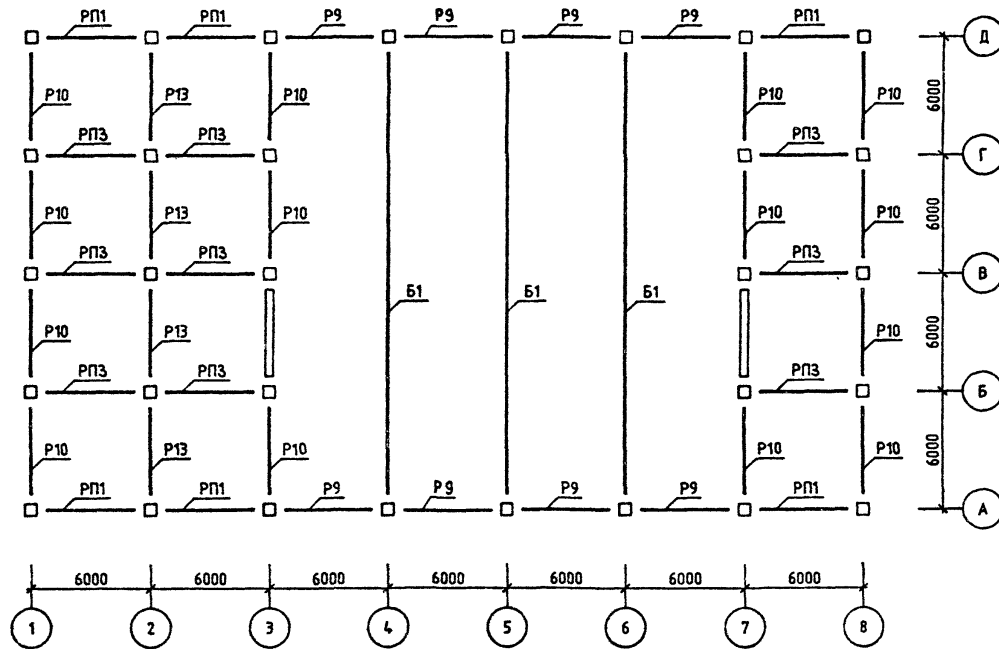

1.220.1-3М.0-1.4 270Б

ЛИСТ

6

23171-04 118. ФОРМАТ А3

Номер загрузки	Тип усиления	Номер группы элементов							
		1	2	3	4	5	6	7	8
ЯРУС 1 СЕЧЕНИЕ 1									
1	N	0.0	0.0	0.0	0.0	-13.8	-10.9	0.0	0.0
	MX	2.5	2.4	4.3	4.2	-10.7	3.9	1.7	3.9
	MY	-0.7	-0.6	-1.1	-1.0	6.1	-0.9	-0.3	-0.9
	QX	-3.6	-6.3	-4.5	7.4	-6.0	-4.8	-2.0	-2.7
8	N	0.0	0.0	0.0	0.0	-0.4	-15.8	0.0	0.0
	MX	0.0	-0.1	0.1	-0.1	-0.2	0.0	0.0	0.0
	MY	-0.1	0.0	0.0	0.0	0.1	0.0	0.0	0.0
	QX	0.3	0.2	0.2	0.0	1.6	-10.0	-1.8	-0.6
9	N	0.0	0.0	0.0	0.0	-35.5	0.1	0.0	0.0
	MX	1.1	1.8	1.9	3.2	15.0	1.5	1.3	1.3
	MY	-0.3	-0.5	-0.5	-0.7	-8.5	-0.2	-0.2	-0.2
	QX	0.1	0.1	0.1	0.1	-0.1	0.0	0.0	0.0
14	N	94.5	127.1	122.3	160.4	120.8	121.4	82.4	150.8
	MX	-0.5	0.0	-1.3	0.0	1.5	-2.3	0.0	-2.4
	MY	0.4	0.0	1.0	0.0	-1.2	1.5	0.0	1.5
	QX	-1.0	-1.6	0.1	0.1	-0.2	-0.1	0.0	-0.1
ЯРУС 1 СЕЧЕНИЕ 2									
1	N	0.0	0.0	0.0	0.0	13.8	10.9	0.0	0.0
	MX	0.0	-0.3	-0.5	-0.9	-10.6	-0.7	-0.7	-0.8
	MY	-0.5	0.6	1.1	1.0	6.1	0.9	0.3	0.9
	QX	-1.0	1.0	0.7	-1.7	-1.3	-5.0	0.8	0.4
8	N	0.0	0.0	0.0	0.0	0.4	15.8	0.0	0.0
	MX	0.0	0.0	0.0	0.0	0.1	0.0	0.0	0.0
	MY	0.0	0.0	0.0	0.0	0.1	0.0	0.0	0.0
	QX	1.1	1.3	1.3	1.6	5.9	-9.6	0.7	1.3
9	N	0.0	0.0	0.0	0.0	35.5	-0.1	0.0	0.0
	MX	-0.1	-0.3	-0.3	-0.7	14.9	-0.8	-0.5	-0.6
	MY	0.2	0.4	0.4	0.7	8.5	0.2	0.2	0.2
	QX	0.1	0.0	0.0	0.0	-0.1	-0.1	0.0	0.0
14	N	-94.5	-127.1	-122.3	-160.4	-120.8	-121.4	-82.4	-150.8
	MX	-0.8	0.0	-2.1	0.0	2.7	-3.0	0.0	2.7
	MY	-0.4	0.0	-1.0	0.0	1.2	-1.5	0.0	1.5
	QX	-1.5	-2.7	0.0	0.0	-0.2	-0.2	0.0	0.0

1.220.1-3М.0-1.4 27МУ1

ГИП	Егунов	
И.КОНТР.	Бойко	
РУК.ГР.	Рудавин	
ПРОВЕРИЛ	Футорная	
РАЗРАБ	Зуенко	

ЗДАНИЕ
ЭТ 4.7.30-ЗАЛ(24)32-3.5

СТАДИЯ	ЛИСТ	ЛИСТОВ
Р	1	3
ГОСГРАЖДАНСТРОЙ		
КиевЗНИИЭП		

ФОРМАТ А4

Номер загрузки	Тип усиления	Номер группы элементов							
		1	2	3	4	5	6	7	8
ЯРУС 2 СЕЧЕНИЕ 1									
1	N	0.0	0.0	0.0	0.0	3.2	0.4	0.0	0.0
	MX	0.0	0.3	0.5	0.9	0.2	0.5	0.7	0.8
	MY	-0.5	-0.6	-1.1	-1.0	-0.2	-0.4	-0.3	-0.9
	QX	-0.1	-1.0	-0.7	1.7	-0.6	0.1	-0.8	-0.4
8	N	0.0	0.0	0.0	0.0	0.4	-4.3	0.0	0.0
	MX	0.0	0.0	0.0	0.0	0.0	0.0	0.0	0.0
	MY	-0.1	0.0	0.0	0.0	0.0	0.0	0.0	0.0
	QX	0.3	0.2	0.2	0.0	1.0	0.6	-0.3	0.2
9	N	0.0	0.0	0.0	0.0	10.5	0.3	0.0	0.0
	MX	0.1	0.3	0.3	0.7	0.2	0.2	0.5	0.6
	MY	-0.2	-0.4	-0.4	-0.7	-0.1	-0.1	-0.2	-0.2
	QX	-0.1	0.0	0.0	0.0	0.0	0.0	0.0	0.0
14	N	67.0	93.2	89.5	122.1	48.2	76.4	44.1	118.1
	MX	0.6	0.0	1.2	0.0	-0.4	-0.6	0.0	-0.6
	MY	-0.4	0.0	-0.9	0.0	0.1	0.7	0.0	1.5
	QX	-0.9	1.4	0.0	0.0	0.0	0.5	0.0	0.0
ЯРУС 2 СЕЧЕНИЕ 2									
1	N	0.0	0.0	0.0	0.0	-3.2	-0.4	0.0	0.0
	MX	1.7	1.1	2.1	1.4	0.2	0.6	0.0	1.3
	MY	0.7	0.6	1.1	1.0	0.2	0.4	-0.1	0.9
	QX	-2.3	-2.7	-1.9	2.2	-1.8	0.1	0.0	-1.2
8	N	0.0	0.0	0.0	0.0	-0.4	4.3	0.0	0.0
	MX	0.0	0.0	0.0	0.0	0.0	0.0	0.0	0.0
	MY	0.0	0.0	0.0	0.0	0.0	0.0	0.0	0.0
	QX	1.8	1.8	1.8	1.8	2.4	0.8	0.0	1.8
9	N	0.0	0.0	0.0	0.0	-10.5	-0.3	0.0	0.0
	MX	0.7	0.8	0.8	1.0	0.2	0.1	0.0	-0.1
	MY	0.3	0.5	0.5	0.7	0.1	0.1	0.2	0.2
	QX	0.1	0.1	0.2	0.1	-0.1	0.0	0.0	0.1
14	N	-67.0	-93.2	-89.5	-122.1	-48.2	-76.4	-44.1	-118.1
	MX	-0.4	0.0	-1.3	0.0	-0.2	-1.1	0.0	-2.9
	MY	-0.4	0.0	-1.0	0.0	0.0	-0.7	0.0	-1.5
	QX	-0.8	-1.5	-0.1	-0.1	-0.1	1.3	0.0	-0.1

1.220.1-3М.0-1.4 27МУ1

ЛИСТ
2

23171-04 119

ФОРМАТ А4

Номер загрузки	Тип усилия	Номер группы элементов							
		1	2	3	4	5	6	7	8
ЯРУС 3 СЕЧЕНИЕ 1									
1	N	0.0	0.0	0.0	0.0	1.7	0.0	0.0	0.0
	MX	-1.7	-1.1	-2.1	-1.4	0.1	-1.5	0.0	-1.3
	QY	0.6	0.4	0.8	0.5	0.0	0.2	0.0	0.2
	MU	2.3	2.7	1.9	-2.2	1.4	0.3	0.0	1.2
	QX	0.8	0.9	0.6	-0.3	0.4	-0.1	0.0	0.4
8	N	0.0	0.0	0.0	0.0	0.2	-0.7	0.0	0.0
	MX	0.0	0.0	0.0	0.0	0.0	0.0	0.0	0.0
	QY	0.0	0.0	0.0	0.0	0.0	0.0	0.0	0.0
	MU	-1.8	-1.8	-1.8	-1.8	-2.0	-6.7	0.0	-1.8
	QX	-0.3	-0.3	-0.3	-0.3	-0.4	-2.1	0.0	-0.2
9	N	0.0	0.0	0.0	0.0	6.3	0.0	0.0	0.0
	MX	-0.7	-0.8	-0.8	-1.0	0.2	0.3	0.0	0.1
	QY	0.3	0.3	0.3	0.4	-0.1	-0.5	0.0	-0.4
	MU	-0.1	-0.1	-0.2	-0.1	0.1	-0.2	0.0	-0.1
	QX	0.0	0.0	0.0	-0.1	0.0	0.1	0.0	0.0
14	N	44.3	60.9	58.5	78.0	14.2	86.6	0.0	87.0
	MX	0.5	0.0	1.0	0.0	-0.4	1.7	0.0	1.0
	QY	-0.3	0.0	-0.7	0.0	0.3	-1.3	0.0	-1.2
	MU	1.1	1.6	0.1	0.1	0.2	-1.3	0.0	0.1
	QX	-0.6	0.8	-0.1	-0.1	0.1	0.5	0.0	0.0
ЯРУС 3 СЕЧЕНИЕ 2									
1	N	0.0	0.0	0.0	0.0	-1.7	0.0	0.0	0.0
	MX	-0.3	-0.2	-0.5	-0.3	0.0	0.8	0.0	0.7
	QY	-0.6	-0.4	-0.8	-0.5	0.0	-0.2	0.0	-0.2
	MU	0.2	-0.2	0.2	-0.1	0.1	0.2	0.0	0.1
	QX	0.7	-0.9	-0.6	0.3	-0.4	0.1	0.0	-0.4
8	N	0.0	0.0	0.0	0.0	-0.2	0.7	0.0	0.0
	MX	0.0	0.0	0.0	0.0	0.0	0.0	0.0	0.0
	QY	0.0	0.0	0.0	0.0	0.0	0.0	0.0	0.0
	MU	0.9	0.9	0.9	0.9	0.5	-0.4	0.0	1.0
	QX	0.3	0.3	0.3	0.3	0.4	2.1	0.0	0.2
9	N	0.0	0.0	0.0	0.0	-6.3	0.0	0.0	0.0
	MX	-0.2	-0.2	-0.2	-0.2	0.2	1.2	0.0	1.3
	QY	-0.3	-0.3	-0.3	-0.4	0.1	0.5	0.0	0.4
	MU	-0.2	-0.1	-0.2	-0.1	0.1	-0.2	0.0	-0.1
	QX	0.0	0.0	-0.1	0.1	0.0	-0.1	0.0	0.0
14	N	-44.3	-60.9	-58.5	-78.0	-14.2	-86.6	0.0	-87.0
	MX	0.6	0.0	1.2	0.0	-0.5	-2.6	0.0	-3.0
	QY	0.3	0.0	0.7	0.0	-0.3	-1.3	0.0	-1.2
	MU	0.8	1.2	0.2	0.2	0.3	-0.4	0.0	0.1
	QX	0.6	-0.8	0.1	-0.1	-0.1	-0.5	0.0	-0.1
ЛИСТ 3									
1.220.1-3М.0-1.4 27МУ									

ФОРМАТ А4

Номер загрузки	Тип усилия	Номер группы элементов									
		1	2	3	4	5	6	7	8		
ЯРУС 1 СЕЧЕНИЕ 1											
1	N	0.0	0.0	0.0	0.0	-12.6	-4.3	0.0	0.0		
	MX	7.0	6.5	11.4	9.7	-38.6	12.2	4.5	10.0		
	QY	-2.0	-1.7	-3.1	-2.5	29.8	-2.9	-0.9	-2.5		
	MU	-9.7	-15.6	-11.1	15.7	-14.8	-17.6	-4.7	-6.7		
	QX	-2.8	-4.1	-2.9	2.2	3.7	-13.3	-0.3	-1.8		
8	N	0.0	0.0	0.0	0.0	-0.6	-17.8	0.0	0.0		
	MX	0.0	-0.1	-0.1	-0.1	0.0	0.0	0.0	0.0		
	QY	0.0	0.0	0.0	0.0	0.0	0.0	0.0	0.0		
	MU	0.8	1.0	1.1	1.3	2.5	-8.4	-1.1	1.1		
	QX	0.5	0.6	0.6	0.7	2.7	-6.5	-0.2	0.6		
9	N	0.0	0.0	0.0	0.0	33.7	0.3	0.0	0.0		
	MX	0.5	0.9	0.9	1.3	12.1	0.8	0.7	0.3		
	QY	-0.1	-0.2	-0.2	-0.3	-9.8	0.0	-0.1	0.0		
	MU	0.1	0.0	0.1	0.1	0.0	-0.1	0.0	0.0		
	QX	0.0	0.0	0.0	0.0	0.0	-0.1	0.0	0.0		
14	N	94.5	127.1	122.3	160.4	112.9	133.9	82.4	150.8		
	MX	-0.3	0.0	-0.6	-0.1	3.5	-1.8	0.0	-2.4		
	QY	0.4	0.0	1.1	0.0	-3.8	1.8	0.0	1.8		
	MU	0.6	-0.7	0.2	0.3	0.3	-0.1	0.0	-0.2		
	QX	0.8	-1.3	-0.1	0.1	0.1	0.1	0.0	-0.1		
ЯРУС 1 СЕЧЕНИЕ 2											
1	N	0.0	0.0	0.0	0.0	12.6	4.3	0.0	0.0		
	MX	-2.0	-2.2	-3.7	-3.4	-36.0	-5.0	-2.2	-3.7		
	QY	2.0	1.7	3.1	2.5	-29.8	2.9	0.9	2.5		
	MU	2.9	5.3	3.8	-5.8	-4.5	-16.5	2.3	2.3		
	QX	2.8	4.1	2.9	-2.2	-3.7	13.3	0.3	1.8		
8	N	0.0	0.0	0.0	0.0	0.6	17.8	0.0	0.0		
	MX	0.0	0.0	0.0	0.0	0.0	0.0	0.0	0.0		
	QY	0.0	0.0	0.0	0.0	0.0	0.0	0.0	0.0		
	MU	0.6	0.6	0.6	0.5	4.5	-7.8	0.5	0.5		
	QX	-0.5	-0.6	-0.6	-0.7	-2.6	6.5	0.2	-0.6		
9	N	0.0	0.0	0.0	0.0	-33.7	-0.3	0.0	0.0		
	MX	-0.2	-0.3	-0.3	-0.5	12.4	-0.8	-0.3	-0.3		
	QY	0.1	0.2	0.2	0.3	9.8	0.0	0.1	-0.1		
	MU	0.0	0.0	0.0	0.0	0.0	-0.1	0.0	0.0		
	QX	0.0	0.0	0.0	0.0	0.0	-0.1	0.0	0.0		
14	N	-94.5	-127.1	-122.3	-160.4	-112.9	-133.9	-82.4	-150.8		
	MX	0.8	0.0	2.1	0.0	6.0	2.7	0.0	2.1		
	QY	0.4	0.0	1.1	0.0	3.8	1.8	0.0	1.8		
	MU	-1.5	2.6	0.0	-0.1	-0.1	-0.4	0.0	0.0		
	QX	-0.8	1.3	-0.1	-0.1	-0.1	0.1	0.0	0.1		
1.220.1-3М.0-1.4 27МУ											
ИНВЕН ПОДЛ		ПОДПИСЬ И ДАТА		ВЗАМ ИНВЕН							
ГИП		Егунов									
И.КОНТР.		Бойко									
РУК.ГР.		Рудавин									
ПРОВЕРИЛ		Футорная									
РАЗРАБ		Зуевко									
						СТАДИЯ		ЛИСТ		ЛИСТОВ	
						Р		1		3	
						ЗДАНИЕ 3Т 4.7.30-ЗАЛ(24)40-2.5					
						ГОСГРАЖДАНСТРОЙ КиевЗНИИЭП					
23171-04 120											

ФОРМАТ А4

Номер загрузки	Тип усилия	Номер группы элементов							
		1	2	3	4	5	6	7	8
ЯРУС 2 СЕЧЕНИЕ 1									
1	N	0.0	0.0	0.0	0.0	-9.9	-5.0	0.0	0.0
	MX	2.0	2.2	3.7	3.4	0.4	1.8	2.2	3.7
	QY	-2.0	-1.7	-3.1	-2.5	-0.3	-1.3	-0.9	-2.5
	MU	-2.9	-5.3	-3.8	5.8	-2.1	-0.3	-2.3	-2.3
	QX	-2.8	-4.1	-2.9	2.2	1.6	0.2	-0.3	-1.8
8	N	0.0	0.0	0.0	0.0	-0.4	-5.1	0.0	0.0
	MX	0.0	0.0	0.0	0.0	0.0	0.0	0.0	0.0
	QY	0.0	0.0	0.0	0.0	0.0	0.0	0.0	0.0
	MU	-0.6	-0.6	-0.6	-0.5	0.5	0.3	-0.5	-0.5
	QX	0.5	0.6	0.6	0.7	1.4	0.3	-0.2	0.6
9	N	0.0	0.0	0.0	0.0	11.3	-0.2	0.0	0.0
	MX	0.2	0.3	0.3	0.5	0.3	0.1	0.3	0.3
	QY	-0.1	-0.2	-0.2	-0.3	-0.2	0.0	-0.1	0.1
	MU	0.0	0.0	0.0	0.0	0.0	0.0	0.0	0.0
	QX	0.0	0.0	0.0	0.0	0.0	0.0	0.0	0.0
14	N	67.0	93.2	89.5	122.1	42.7	78.5	44.1	118.1
	MX	-0.6	0.0	-1.2	0.0	-0.2	-0.7	0.0	-1.1
	QY	0.4	0.0	1.0	0.0	0.0	0.8	0.0	1.8
	MU	1.0	1.5	0.0	0.1	-0.1	0.3	0.0	0.0
	QX	-0.8	-1.3	0.1	0.1	0.1	-0.6	0.0	-0.1
ЯРУС 2 СЕЧЕНИЕ 2									
1	N	0.0	0.0	0.0	0.0	9.9	5.0	0.0	0.0
	MX	2.8	2.0	3.6	2.5	0.3	1.3	0.0	2.2
	QY	2.0	1.7	3.1	2.5	0.3	1.3	-0.4	2.5
	MU	-3.7	-4.5	-3.2	3.7	-3.0	-0.3	0.0	-2.0
	QX	2.8	4.1	2.9	-2.2	-1.6	-0.2	-0.3	1.8
8	N	0.0	0.0	0.0	0.0	0.4	5.1	0.0	0.0
	MX	0.0	0.0	0.0	0.0	0.0	0.0	0.0	0.0
	QY	0.0	0.0	0.0	0.0	0.0	0.0	0.0	0.0
	MU	1.9	2.0	2.0	2.1	2.8	0.4	0.0	2.0
	QX	-0.5	-0.6	-0.6	-0.7	-1.4	-0.3	0.2	-0.6
9	N	0.0	0.0	0.0	0.0	-11.3	0.2	0.0	0.0
	MX	0.2	0.2	0.2	0.3	0.3	-0.2	0.0	-0.6
	QY	0.1	0.2	0.2	0.3	0.2	0.0	0.1	-0.1
	MU	0.1	0.1	0.1	0.1	0.0	0.0	0.0	0.0
	QX	0.0	0.0	0.0	0.0	0.0	0.0	0.0	0.0
14	N	-67.0	-93.2	-89.5	-122.1	-42.7	-78.5	-44.1	-118.1
	MX	-0.5	0.0	-1.4	0.0	-0.3	-1.3	0.0	-3.2
	QY	-0.4	0.0	-1.1	0.0	-0.1	-0.8	0.0	-1.8
	MU	1.0	-1.7	-0.1	-0.2	-0.2	1.2	0.0	-0.1
	QX	-0.8	-1.3	0.1	-0.1	0.1	-0.6	0.0	0.1
1.220.1-3М.0-1.4 27МУ									ЛИСТ 2

ФОРМАТ А4

Номер загрузки	Тип усилия	Номер группы элементов							
		1	2	3	4	5	6	7	8
ЯРУС 3 СЕЧЕНИЕ 1									
1	N	0.0	0.0	0.0	0.0	-3.1	0.0	0.0	0.0
	MX	-2.8	-2.0	-3.6	-2.5	0.1	-2.0	0.0	-2.2
	QY	1.0	0.7	1.4	1.0	-0.1	0.3	0.0	0.3
	MU	3.7	4.5	3.2	-3.7	1.9	0.2	0.0	2.0
	QX	1.2	1.5	1.0	-0.6	-0.2	0.1	0.0	0.6
8	N	0.0	0.0	0.0	0.0	0.2	-0.6	0.0	0.0
	MX	0.0	0.0	0.0	0.0	0.0	0.0	0.0	0.0
	QY	0.0	0.0	0.0	0.0	0.0	0.0	0.0	0.0
	MU	-1.9	-2.0	-2.0	-2.1	-2.1	-4.9	0.0	-2.0
	QX	-0.3	-0.4	-0.4	-0.4	-0.5	-1.5	0.0	-0.4
9	N	0.0	0.0	0.0	0.0	6.3	0.0	0.0	0.0
	MX	-0.2	-0.2	-0.2	-0.3	0.2	0.9	0.0	0.6
	QY	0.1	0.1	0.1	0.1	-0.1	-0.6	0.0	-0.5
	MU	-0.1	-0.1	-0.1	-0.1	0.0	-0.2	0.0	0.0
	QX	0.0	0.0	0.0	0.0	0.0	0.1	0.0	0.0
14	N	44.3	60.9	58.5	78.0	12.5	86.6	0.0	87.0
	MX	0.4	0.0	0.9	0.0	-0.4	1.9	0.0	1.2
	QY	-0.3	0.0	-0.6	0.0	0.3	-1.3	0.0	-1.2
	MU	0.9	1.4	0.1	0.2	0.2	-1.2	0.0	0.1
	QX	-0.5	0.8	-0.1	-0.1	0.2	0.5	0.0	0.1
ЯРУС 3 СЕЧЕНИЕ 2									
1	N	0.0	0.0	0.0	0.0	3.1	0.0	0.0	0.0
	MX	-0.5	-0.4	-0.9	-0.6	0.1	1.0	0.0	1.1
	QY	-1.0	-0.7	-1.4	-1.0	0.1	-0.3	0.0	-0.3
	MU	0.3	-0.4	0.3	-0.3	0.2	0.2	0.0	0.2
	QX	-1.2	-1.5	-1.0	0.6	0.2	-0.1	0.0	-0.6
8	N	0.0	0.0	0.0	0.0	-0.2	0.6	0.0	0.0
	MX	0.0	0.0	0.0	0.0	0.0	0.0	0.0	0.0
	QY	0.0	0.0	0.0	0.0	0.0	0.0	0.0	0.0
	MU	0.9	0.9	0.9	0.8	0.5	0.0	0.0	0.9
	QX	0.3	0.3	0.4	0.4	0.5	1.5	0.0	0.4
9	N	0.0	0.0	0.0	0.0	-6.3	0.0	0.0	0.0
	MX	-0.1	-0.1	-0.1	-0.1	0.2	1.0	0.0	1.1
	QY	-0.1	-0.1	-0.1	-0.1	0.1	0.6	0.0	0.5
	MU	-0.1	0.0	-0.1	0.0	0.0	-0.1	0.0	0.0
	QX	0.0	0.0	0.1	0.0	0.0	-0.1	0.0	0.0
14	N	-44.3	-60.9	-58.5	-78.0	-12.5	-86.6	0.0	-87.0
	MX	0.5	0.0	1.2	0.0	-0.5	-2.5	0.0	-2.9
	QY	0.3	0.0	0.6	0.0	-0.3	-1.3	0.0	-1.2
	MU	0.7	1.1	0.2	0.3	0.3	-0.4	0.0	0.1
	QX	0.5	-0.7	0.1	-0.1	-0.2	-0.5	0.0	-0.1
1.220.1-3М.0-1.4 27МУ									ЛИСТ 3

23171-04 121

ФОРМАТ А4

Номер загрузки	Тип усилия	Номер группы элементов							
		1	2	3	4	5	6	7	8
ЯРУС 1 СЕЧЕНИЕ 1									
1	N	0.0	0.0	0.0	0.0	-13.9	-10.2	0.0	0.0
	MX	2.5	2.4	4.3	4.1	-11.0	5.9	2.4	4.2
	QY	-0.7	-0.6	-1.1	-0.9	6.3	-2.2	-0.6	-1.1
	MY	-3.7	-6.4	-4.6	7.6	-6.3	-4.6	-2.7	-2.8
	QX	-1.1	-1.6	-1.1	1.0	1.8	-2.6	-0.7	-0.7
8	N	0.0	0.0	0.0	0.0	0.5	-25.4	0.0	0.0
	MX	0.0	0.0	0.0	0.1	-0.1	0.0	0.0	0.0
	QY	0.0	0.0	0.0	0.0	0.0	0.0	0.0	0.0
	MY	-0.9	-1.6	-1.6	-2.7	-2.9	-6.1	-1.3	-1.6
	QX	-0.3	-0.4	-0.4	-0.6	-0.8	-3.5	-0.3	-0.4
9	N	0.0	0.0	0.0	0.0	-55.4	-0.9	0.0	0.0
	MX	1.3	2.2	2.2	3.7	18.1	2.8	2.1	2.3
	QY	-0.3	-0.5	-0.5	-0.8	-10.4	-1.0	-0.5	-0.6
	MY	0.0	0.0	0.0	0.0	0.0	0.0	0.0	0.0
	QX	0.0	0.0	0.0	0.0	0.0	0.0	0.0	0.0
14	N	117.1	159.4	153.3	204.5	154.3	136.5	126.5	181.9
	MX	0.5	0.0	1.2	0.0	-2.6	1.1	0.0	0.9
	QY	-0.4	0.0	-0.9	0.0	2.0	-0.8	0.0	-0.8
	MY	-1.0	1.7	0.0	0.0	0.0	1.2	0.0	0.0
	QX	-0.7	1.2	0.0	0.0	0.0	-0.9	0.0	0.0
ЯРУС 1 СЕЧЕНИЕ 2									
1	N	0.0	0.0	0.0	0.0	13.9	10.2	0.0	0.0
	MX	0.0	-0.3	-0.5	-0.9	-10.9	1.7	-0.3	-0.6
	QY	-0.5	0.6	1.1	0.9	-6.3	2.2	0.6	1.1
	MY	0.0	0.8	0.6	-1.6	-1.7	-4.6	0.4	0.4
	QX	-1.0	-1.5	-1.1	-1.0	-1.8	2.6	0.2	0.7
8	N	0.0	0.0	0.0	0.0	-0.5	25.4	0.0	0.0
	MX	0.0	0.0	0.0	0.0	0.0	0.0	0.0	0.0
	QY	0.0	0.0	0.0	0.0	0.0	0.0	0.0	0.0
	MY	-0.1	0.1	0.1	0.5	-0.3	-6.1	0.3	0.1
	QX	0.3	0.4	0.4	0.6	0.8	3.5	0.3	0.4
9	N	0.0	0.0	0.0	0.0	55.4	0.9	0.0	0.0
	MX	-0.1	-0.4	-0.4	-0.9	18.2	0.5	-0.4	-0.3
	QY	0.3	0.5	0.5	0.8	10.4	1.0	0.5	0.5
	MY	0.0	0.0	0.0	0.0	0.0	0.0	0.0	0.0
	QX	0.0	0.0	0.0	0.0	0.0	0.0	0.0	0.0
14	N	-117.1	-159.4	-153.3	-204.5	-154.3	-136.5	-126.5	-181.9
	MX	0.8	0.0	2.1	0.0	-4.5	1.6	0.0	1.9
	QY	0.4	0.0	0.9	0.0	-2.0	0.8	0.0	0.8
	MY	-1.5	2.7	0.0	0.0	0.0	2.0	0.0	0.0
	QX	0.7	1.2	0.0	0.0	0.0	0.9	0.0	0.0

1.220.1-3М.0-1.4 27МУЗ

ГИП	Егунов		СТАДИЯ	ЛИСТ	ЛИСТОВ
И.КОНТР	Бойко		Р	1	4
РУК.ГР	Рудовиц		ГОСГРАЖДАНСТРОЙ КиевЗНИИЭП		
ПРОВЕРИЛ	Футорная				
РАЗРАБ	Зубяко	Л.И.А.	ЗДАНИЕ 4Т 4.7.30-ЗАЛ(24)32-3.5		

Номер загрузки	Тип усилия	Номер группы элементов							
		1	2	3	4	5	6	7	8
ЯРУС 2 СЕЧЕНИЕ 1									
1	N	0.0	0.0	0.0	0.0	3.5	2.2	0.0	0.0
	MX	0.0	0.3	0.5	0.9	0.3	0.6	0.3	0.6
	QY	0.5	-0.6	-1.1	-0.9	-0.2	-1.1	-0.6	-1.1
	MY	0.0	-0.8	-0.6	1.6	-0.7	0.1	-0.4	-0.4
	QX	1.0	1.5	1.1	1.0	0.9	-0.1	-0.2	-0.7
8	N	0.0	0.0	0.0	0.0	-0.5	-12.0	0.0	0.0
	MX	0.0	0.0	0.0	0.0	0.0	0.0	0.0	0.0
	QY	0.0	0.0	0.0	0.0	0.0	0.0	0.0	0.0
	MY	0.1	-0.1	-0.1	-0.5	-0.4	-0.4	-0.3	-0.1
	QX	-0.3	-0.4	-0.4	-0.6	-0.5	-0.3	-0.3	-0.4
9	N	0.0	0.0	0.0	0.0	21.6	-0.7	0.0	0.0
	MX	0.1	0.4	0.4	0.9	0.6	0.3	0.4	0.3
	QY	-0.3	-0.5	-0.5	-0.8	-0.4	-0.5	-0.5	-0.5
	MY	0.0	0.0	0.0	0.0	0.0	0.0	0.0	0.0
	QX	0.0	0.0	0.0	0.0	0.0	0.0	0.0	0.0
14	N	89.6	125.4	120.6	166.2	67.0	70.7	88.2	142.1
	MX	-0.6	0.0	-1.2	0.0	0.8	0.4	0.0	-1.3
	QY	0.4	0.0	0.9	0.0	-0.4	-0.3	0.0	0.8
	MY	0.9	-1.4	0.0	0.0	0.0	-0.5	0.0	0.0
	QX	0.7	-1.2	0.0	0.0	0.0	-0.1	0.0	0.0
ЯРУС 2 СЕЧЕНИЕ 2									
1	N	0.0	0.0	0.0	0.0	-3.5	-2.2	0.0	0.0
	MX	1.7	1.1	2.0	1.4	0.2	1.9	1.1	2.0
	QY	0.7	0.6	1.1	0.9	0.2	1.1	0.6	1.1
	MY	-2.5	-2.9	-2.1	2.5	-2.1	0.1	-1.2	-1.3
	QX	1.1	1.6	1.1	-1.0	-0.9	-0.1	0.7	0.7
8	N	0.0	0.0	0.0	0.0	0.5	12.0	0.0	0.0
	MX	0.0	0.0	0.0	0.0	0.0	0.0	0.0	0.0
	QY	0.0	0.0	0.0	0.0	0.0	0.0	0.0	0.0
	MY	-0.7	-0.9	-1.0	-1.1	-0.7	-0.2	-0.4	-1.0
	QX	0.3	0.4	0.4	0.6	0.5	0.3	0.3	0.4
9	N	0.0	0.0	0.0	0.0	-21.6	0.7	0.0	0.0
	MX	0.8	0.9	0.9	1.1	0.4	0.8	0.8	1.0
	QY	0.3	0.5	0.5	0.8	0.4	0.5	0.5	0.6
	MY	-0.1	0.0	-0.1	0.0	0.0	0.0	0.0	0.0
	QX	0.0	0.0	0.0	0.0	0.0	0.0	0.0	0.0
14	N	-89.6	-125.4	-120.6	-166.2	-67.0	-70.7	-88.2	-149.1
	MX	0.4	0.0	1.0	0.0	0.2	0.3	0.0	0.6
	QY	0.4	0.0	0.9	0.0	0.4	0.3	0.0	0.8
	MY	-0.8	1.5	-0.1	0.1	0.0	0.2	0.0	0.1
	QX	0.7	-1.2	0.0	0.0	0.0	0.1	0.0	0.0

Безупо
ОПЕРАТОР
СИСТЕМЫ
САПР
КиевЗНИИЭП

ВЗАМ. ИМ. ИЛИ
ПОДПИСЬ И ДАТА
ИМ. ИЛИ ПОДП.

1.220.1-3М.0-1.4 27МУЗ

Номер загрузки	Тип усилия	Номер группы элементов							
		1	2	3	4	5	6	7	8
ЯРУС 3 СЕЧЕНИЕ 1									
1	N	0.0	0.0	0.0	0.0	1.8	1.2	0.0	0.0
	MX	-1.7	-1.1	-2.0	-1.4	0.1	-1.8	-1.1	-2.0
	QY	0.6	0.4	0.8	0.5	0.0	0.8	0.3	0.7
	MU	2.5	2.9	2.1	-2.5	1.8	0.1	1.2	1.3
	QX	0.9	1.1	0.8	-0.5	0.7	0.0	0.4	0.5
8	N	0.0	0.0	0.0	0.0	0.3	-7.6	0.0	0.0
	MX	0.0	0.0	0.0	0.0	0.0	0.0	0.0	0.0
	QY	0.0	0.0	0.0	0.0	0.0	0.0	0.0	0.0
	MU	0.7	0.9	1.0	1.1	1.5	-0.1	0.4	1.0
	QX	0.8	0.9	1.0	1.0	1.3	0.0	0.1	1.0
9	N	0.0	0.0	0.0	0.0	13.2	-0.5	0.0	0.0
	MX	-0.8	-0.9	-0.9	-1.1	0.4	-0.9	-0.8	-1.0
	QY	0.3	0.3	0.4	0.4	-0.2	0.4	0.3	0.6
	MU	0.1	0.0	0.1	0.0	0.0	0.0	0.0	0.0
	QX	0.0	0.0	0.0	0.0	0.0	0.0	0.0	0.0
14	N	67.0	93.2	89.5	122.1	26.3	63.4	44.1	118.1
	MX	-0.4	0.0	-1.0	0.0	0.3	-0.7	0.0	-1.4
	QY	0.2	0.0	0.7	0.0	-0.2	0.6	0.0	1.3
	MU	1.0	-1.6	0.1	-0.1	-0.1	0.8	0.0	-0.1
	QX	0.6	0.9	0.1	0.1	-0.1	-0.7	0.0	-0.1
ЯРУС 3 СЕЧЕНИЕ 2									
1	N	0.0	0.0	0.0	0.0	-1.8	-1.2	0.0	0.0
	MX	-0.4	-0.3	-0.5	-0.3	0.1	-0.7	0.0	-0.3
	QY	-0.6	-0.4	-0.8	-0.5	0.0	-0.8	-0.3	-0.7
	MU	0.5	0.6	0.4	-0.5	0.7	0.1	0.0	0.3
	QX	-0.9	-1.1	-0.8	0.5	-0.7	0.0	-0.1	-0.5
8	N	0.0	0.0	0.0	0.0	-0.3	7.6	0.0	0.0
	MX	0.0	0.0	-0.1	-0.1	0.0	0.0	0.0	0.0
	QY	0.0	0.0	0.0	0.0	0.0	0.0	0.0	0.0
	MU	2.1	2.2	2.2	2.2	2.7	0.0	0.0	2.2
	QX	-0.8	-0.9	-1.0	-1.0	-1.3	0.0	-0.1	-1.0
9	N	0.0	0.0	0.0	0.0	-13.2	0.5	0.0	0.0
	MX	-0.2	-0.2	-0.2	-0.2	0.3	-0.6	0.0	-0.9
	QY	-0.3	-0.3	-0.4	-0.4	0.2	-0.4	-0.2	-0.6
	MU	0.0	0.0	0.1	0.0	0.0	0.0	0.0	0.0
	QX	0.0	0.0	0.0	0.0	0.0	0.0	0.0	0.0
14	N	-67.0	-93.2	-89.5	-122.1	-26.3	-63.4	-44.1	-118.1
	MX	-0.4	0.0	-1.2	0.0	0.5	-1.1	0.0	-3.0
	QY	-0.2	0.0	-0.7	0.0	0.2	-0.6	0.0	-1.3
	MU	0.9	-1.6	0.1	-0.2	-0.1	1.5	0.0	-0.1
	QX	-0.6	-0.9	0.0	-0.1	0.1	0.7	0.0	0.1

КиевНИИЭП

1.220.1-3М.0-1.4 27МУ3

ЛИСТ
3

ФОРМАТ А4

Номер загрузки	Тип усилия	Номер группы элементов							
		1	2	3	4	5	6	7	8
ЯРУС 4 СЕЧЕНИЕ 1									
1	N	0.0	0.0	0.0	0.0	0.3	0.0	0.0	0.0
	MX	-0.4	0.3	0.5	0.3	0.0	-0.1	0.0	0.3
	QY	-0.1	-0.1	-0.2	-0.1	0.0	0.0	0.0	0.0
	MU	-0.5	-0.6	-0.4	0.5	-0.1	-0.1	0.0	-0.3
	QX	-0.2	-0.2	-0.1	0.1	0.0	0.0	0.0	-0.1
8	N	0.0	0.0	0.0	0.0	0.2	-0.5	0.0	0.0
	MX	0.0	0.0	0.1	0.1	0.0	0.0	0.0	0.0
	QY	0.0	0.0	0.0	0.0	0.0	0.0	0.0	0.0
	MU	-2.1	-2.2	-2.2	-2.2	-2.1	-4.7	0.0	-2.2
	QX	-0.4	-0.4	-0.4	-0.4	-0.5	-1.4	0.0	-0.4
9	N	0.0	0.0	0.0	0.0	6.5	0.0	0.0	0.0
	MX	-0.2	0.2	0.2	0.2	0.2	1.0	0.0	0.9
	QY	-0.1	-0.1	-0.1	-0.1	-0.1	-0.6	0.0	-0.6
	MU	0.0	0.0	-0.1	0.0	0.0	0.2	0.0	0.0
	QX	0.0	0.0	0.0	0.0	0.0	0.1	0.0	0.0
14	N	44.3	60.9	58.5	78.0	8.3	86.6	0.0	87.0
	MX	0.4	0.0	1.1	0.0	-0.6	1.9	0.0	1.1
	QY	-0.3	0.0	-0.7	0.0	0.4	-1.3	0.0	-1.2
	MU	0.9	1.5	-0.1	0.2	0.2	-1.7	0.0	0.1
	QX	-0.5	0.8	-0.1	-0.1	0.2	-0.7	0.0	0.1
ЯРУС 4 СЕЧЕНИЕ 2									
1	N	0.0	0.0	0.0	0.0	-0.3	0.0	0.0	0.0
	MX	0.7	0.7	0.7	0.7	0.0	0.0	0.0	-0.2
	QY	0.1	0.1	0.2	0.1	0.0	0.0	0.0	0.0
	MU	-0.1	-0.1	0.0	0.0	-0.1	0.0	0.0	0.0
	QX	0.2	0.2	0.1	-0.1	0.0	0.0	0.0	0.1
8	N	0.0	0.0	0.0	0.0	-0.2	0.5	0.0	0.0
	MX	0.0	0.0	0.0	0.0	0.0	0.0	0.0	0.0
	QY	0.0	0.0	0.0	0.0	0.0	0.0	0.0	0.0
	MU	0.9	0.8	0.9	0.8	0.4	0.1	0.0	0.8
	QX	0.4	0.4	0.4	0.4	0.5	1.4	0.0	0.4
9	N	0.0	0.0	0.0	0.0	-6.5	0.0	0.0	0.0
	MX	0.0	0.0	0.0	0.0	0.2	0.9	0.0	1.0
	QY	0.0	0.1	0.1	0.1	0.1	0.6	0.0	0.6
	MU	0.0	0.0	-0.1	0.0	0.0	0.1	0.0	0.0
	QX	0.0	0.0	0.0	0.0	0.0	-0.1	0.0	0.0
14	N	-44.3	-60.9	-58.5	-78.0	-8.3	-86.6	0.0	-87.0
	MX	0.6	0.0	1.2	0.0	-0.6	-2.5	0.0	-2.9
	QY	0.3	0.0	0.7	0.0	-0.4	-1.3	0.0	-1.2
	MU	0.7	1.2	0.2	0.2	0.3	-0.5	0.0	0.1
	QX	0.5	-0.8	0.1	-0.1	-0.2	-0.6	0.0	-0.1

Безгудова
ОПЕРАТОР СИСТЕМЫ
КиевНИИЭП

ИНВ № ПОДЛ
ПОДПИСЬ И ДАТА
ВЗАМ ИНВ №

1.220.1-3М.0-1.4 27МУ3

ЛИСТ
4

23171-04 123 ФОРМАТ А4

Номер загрузки	Тип усилия	Номер группы элементов							
		1	2	3	4	5	6	7	8
ЯРУС 1 СЕЧЕНИЕ 1									
1	N	0.0	0.0	0.0	0.0	-19.2	-13.9	0.0	0.0
	MX	4.3	4.3	7.5	7.1	-20.5	9.6	4.2	7.5
	QU	-1.0	-0.9	-1.5	-1.4	10.2	-2.6	-0.8	-1.5
	MU	-6.4	-11.2	-8.0	12.9	-10.3	-8.8	-4.8	-4.9
	QX	-1.4	-2.3	-1.6	1.4	2.3	-4.4	-1.0	-1.0
8	N	0.0	0.0	0.0	0.0	0.5	-26.4	0.0	0.0
	MX	0.0	0.0	0.0	0.1	-0.1	0.0	0.0	0.0
	QU	0.0	0.0	0.0	0.0	0.0	0.0	0.0	0.0
	MU	-1.0	-1.7	-1.9	-2.9	-2.9	-7.0	-1.3	-1.9
	QX	-0.2	-0.4	-0.4	-0.6	-0.6	-3.5	-0.2	-0.4
9	N	0.0	0.0	0.0	0.0	-57.2	-0.8	0.0	0.0
	MX	1.5	2.7	2.7	4.3	22.5	3.2	2.6	2.8
	QU	-0.3	-0.5	-0.5	-0.8	-11.2	-0.8	-0.5	-0.6
	MU	0.0	0.0	-0.1	0.0	0.0	0.0	0.0	0.0
	QX	0.0	0.0	0.0	0.0	0.0	0.0	0.0	0.0
14	N	117.1	159.4	153.3	204.5	158.9	142.6	126.5	181.9
	MX	0.6	0.0	1.2	0.0	-4.7	1.2	0.0	0.7
	QU	-0.4	0.0	-0.9	0.0	3.3	-0.8	0.0	-0.7
	MU	-1.1	1.7	-0.1	-0.1	0.0	2.2	0.0	0.1
	QX	-0.7	1.1	0.0	0.0	0.0	-1.5	0.0	0.0
ЯРУС 1 СЕЧЕНИЕ 2									
1	N	0.0	0.0	0.0	0.0	19.2	13.9	0.0	0.0
	MX	-0.5	-0.8	-1.4	-1.6	-20.2	0.9	-0.8	-1.4
	QU	0.9	0.9	1.5	1.4	-10.2	2.6	0.8	1.5
	MU	0.7	2.1	1.5	-3.0	-0.8	-9.0	0.9	0.9
	QX	-1.4	2.3	1.6	-1.4	-2.3	4.4	1.0	1.0
8	N	0.0	0.0	0.0	0.0	-0.5	26.4	0.0	0.0
	MX	0.0	0.0	0.0	0.0	-0.1	0.0	0.0	0.0
	QU	0.0	0.0	0.0	0.0	0.0	0.0	0.0	0.0
	MU	0.0	0.2	0.2	0.6	0.5	-7.0	0.4	0.2
	QX	0.2	0.4	0.4	0.6	0.6	3.5	0.2	0.4
9	N	0.0	0.0	0.0	0.0	57.2	0.8	0.0	0.0
	MX	-0.2	-0.6	-0.6	-1.1	22.4	0.0	-0.6	-0.5
	QU	0.3	0.5	0.5	0.8	11.2	0.8	0.5	0.5
	MU	0.0	0.0	0.0	0.0	0.0	0.0	0.0	0.0
	QX	0.0	0.0	0.0	0.0	0.0	0.0	0.0	0.0
14	N	-117.1	-159.4	-153.3	-204.5	-158.9	-142.6	-126.5	-181.9
	MX	0.9	0.0	2.3	0.0	-8.4	2.0	0.0	2.1
	QU	0.4	0.0	0.9	0.0	-3.3	0.8	0.0	0.7
	MU	-1.7	2.9	0.0	0.0	0.0	4.0	0.0	0.0
	QX	0.7	1.1	0.0	0.0	0.0	1.5	0.0	0.0
1.220.1-3М.0-1.4 27МУ4									
ГИП	Егумов								
Н.КОНТР.	Бойко								
РУКЛР.	Рудавин								
ПРОВЕРИЛ	Футорная								
РАЗРАБ	Зуенко								
ЗДАНИЕ				4Т 4.7.30-ЗАЛ(24)40-4.0					
				СТАДИЯ		ЛИСТ		ЛИСТОВ	
				Р		1		4	
ГОСГРАЖДАНСТРОЙ									
КиевЗНИИЭП									

Номер загрузки	Тип усилия	Номер группы элементов							
		1	2	3	4	5	6	7	8
ЯРУС 2 СЕЧЕНИЕ 1									
1	N	0.0	0.0	0.0	0.0	4.9	2.8	0.0	0.0
	MX	0.5	0.8	1.4	1.6	0.4	0.9	0.8	1.4
	QU	-0.9	-0.9	-1.5	-1.4	-0.3	-1.3	-0.8	-1.5
	MU	-0.7	-2.1	-1.5	3.0	-1.0	0.2	-0.9	-0.9
	QX	1.4	-2.3	-1.6	1.4	1.0	0.1	-1.0	-1.0
8	N	0.0	0.0	0.0	0.0	-0.5	-11.2	0.0	0.0
	MX	0.0	0.0	0.0	0.0	0.0	0.0	0.0	0.0
	QU	0.0	0.0	0.0	0.0	0.0	0.0	0.0	0.0
	MU	0.0	-0.2	-0.2	-0.6	-0.4	-0.3	-0.4	-0.2
	QX	-0.2	-0.4	-0.4	-0.6	-0.4	-0.2	-0.2	-0.4
9	N	0.0	0.0	0.0	0.0	19.2	-0.6	0.0	0.0
	MX	0.2	0.6	0.6	1.1	0.4	0.3	0.6	0.5
	QU	-0.3	-0.5	-0.5	-0.8	-0.3	-0.4	-0.5	-0.5
	MU	0.0	0.0	0.0	0.0	0.0	0.0	0.0	0.0
	QX	0.0	0.0	0.0	0.0	0.0	0.0	0.0	0.0
14	N	89.6	125.4	120.6	166.2	65.1	70.3	88.2	149.1
	MX	-0.5	0.0	-1.0	0.0	0.8	0.4	0.0	1.1
	QU	0.4	0.0	0.8	0.0	-0.4	-0.3	0.0	0.7
	MU	0.8	-1.2	0.0	0.0	0.0	-0.5	0.0	0.0
	QX	0.7	-1.1	0.0	0.0	0.0	-0.2	0.0	0.0
ЯРУС 2 СЕЧЕНИЕ 2									
1	N	0.0	0.0	0.0	0.0	-4.9	-2.8	0.0	0.0
	MX	1.8	1.3	2.2	1.6	0.3	2.1	1.2	2.2
	QU	1.0	0.9	1.5	1.4	0.3	1.3	0.8	1.5
	MU	-2.7	-3.3	-2.3	2.9	-2.3	0.2	-1.3	-1.4
	QX	1.4	2.3	1.6	-1.4	-1.0	-0.1	1.0	1.0
8	N	0.0	0.0	0.0	0.0	0.5	11.2	0.0	0.0
	MX	0.0	0.0	0.0	0.0	0.0	0.0	0.0	0.0
	QU	0.0	0.0	0.0	0.0	0.0	0.0	0.0	0.0
	MU	-0.6	-0.7	-0.8	-0.9	-0.5	-0.2	-0.2	-0.8
	QX	0.2	0.4	0.4	0.6	0.4	0.2	0.2	0.4
9	N	0.0	0.0	0.0	0.0	-19.2	0.6	0.0	0.0
	MX	0.6	0.7	0.7	0.9	0.3	0.6	0.6	0.8
	QU	0.3	0.5	0.5	0.8	0.3	0.4	0.5	0.6
	MU	0.0	0.0	0.0	0.0	0.0	0.0	0.0	0.0
	QX	0.0	0.0	0.0	0.0	0.0	0.0	0.0	0.0
14	N	-89.6	-125.4	-120.6	-166.2	-65.1	-70.3	-88.2	-149.1
	MX	0.4	0.0	1.1	0.0	0.2	0.3	0.0	0.6
	QU	0.4	0.0	0.9	0.0	0.4	0.3	0.0	0.7
	MU	-0.9	1.6	-0.1	0.1	0.0	0.2	0.0	0.1
	QX	0.7	-1.1	0.0	0.0	0.0	0.2	0.0	0.0
1.220.1-3М.0-1.4 27МУ4									
23171-04 124									

Номер загрузки	Тип усилия	Номер группы элементов							
		1	2	3	4	5	6	7	8
ЯРУС 3 СЕЧЕНИЕ 1									
1	N	0.0	0.0	0.0	0.0	2.4	1.5	0.0	0.0
	MX	-1.8	-1.3	-2.2	-1.6	0.1	-1.8	-1.2	-2.2
	MY	0.7	0.5	0.8	0.6	-0.1	0.8	0.4	0.8
	QX	2.7	3.3	2.3	-2.9	1.8	0.1	1.3	1.4
8	N	0.0	0.0	0.0	0.0	0.3	-7.3	0.0	0.0
	MX	0.0	0.0	0.0	0.0	0.0	0.0	0.0	0.0
	MY	0.0	0.0	0.0	0.0	0.0	0.0	0.0	0.0
	QX	0.6	0.7	0.8	0.9	1.2	-0.1	0.2	0.8
9	N	0.0	0.0	0.0	0.0	12.5	-0.4	0.0	0.0
	MX	-0.6	-0.7	-0.7	-0.9	0.3	-0.6	-0.6	-0.8
	MY	0.2	0.3	0.3	0.3	-0.2	0.3	0.2	0.5
	QX	0.0	0.0	0.0	0.0	0.0	0.0	0.0	0.0
14	N	67.0	93.2	89.5	122.1	25.5	63.2	44.1	118.1
	MX	-0.4	0.0	-1.0	0.0	0.3	-0.7	0.0	-1.4
	MY	0.2	0.0	0.7	0.0	-0.2	0.5	0.0	1.3
	QX	1.0	-1.5	0.1	-0.1	-0.1	0.8	0.0	-0.1
ЯРУС 3 СЕЧЕНИЕ 2									
1	N	0.0	0.0	0.0	0.0	-2.4	-1.5	0.0	0.0
	MX	-0.4	-0.3	-0.5	-0.4	0.1	-0.8	0.0	-0.3
	MY	-0.7	-0.5	-0.8	-0.6	0.1	-0.8	-0.4	-0.8
	QX	0.5	0.7	0.5	-0.6	0.7	0.1	0.0	0.3
8	N	0.0	0.0	0.0	0.0	-0.3	7.3	0.0	0.0
	MX	0.0	0.0	-0.1	-0.1	0.0	0.0	0.0	0.0
	MY	0.0	0.0	0.0	0.0	0.0	0.0	0.0	0.0
	QX	2.1	2.1	2.2	2.2	2.7	0.0	0.0	2.2
9	N	0.0	0.0	0.0	0.0	-12.5	0.4	0.0	0.0
	MX	-0.1	-0.2	-0.2	-0.2	0.2	-0.4	0.0	-0.8
	MY	-0.2	-0.3	-0.3	-0.3	0.2	-0.3	-0.2	-0.5
	QX	0.0	0.0	0.1	0.0	0.0	0.0	0.0	0.0
14	N	-67.0	-93.2	-89.5	-122.1	-25.5	-63.2	-44.1	-118.1
	MX	-0.4	0.0	-1.2	0.0	0.5	-1.1	0.0	-3.0
	MY	-0.2	0.0	-0.7	0.0	0.2	-0.5	0.0	-1.3
	QX	0.9	-1.6	0.1	-0.2	-0.1	1.5	0.0	-0.1

1.220.1-3Ж.0-1.4 27МУ4

ЛИСТ

3

Номер загрузки	Тип усилия	Номер группы элементов							
		1	2	3	4	5	6	7	8
ЯРУС 4 СЕЧЕНИЕ 1									
1	N	0.0	0.0	0.0	0.0	0.5	0.0	0.0	0.0
	MX	-0.4	-0.3	-0.5	-0.4	0.0	-0.1	0.0	-0.3
	MY	-0.2	-0.1	-0.2	-0.1	0.0	0.0	0.0	-0.1
	QX	-0.5	-0.7	-0.5	0.6	-0.1	-0.1	0.0	-0.3
8	N	0.0	0.0	0.0	0.0	0.2	-0.5	0.0	0.0
	MX	0.0	0.0	0.1	0.1	0.0	0.0	0.0	0.0
	MY	0.0	0.0	0.0	0.0	0.0	0.0	0.0	0.0
	QX	-2.1	-2.1	-2.2	-2.2	-2.1	-4.7	0.0	-2.2
9	N	0.0	0.0	0.0	0.0	6.3	0.0	0.0	0.0
	MX	0.1	0.2	0.2	0.2	0.2	1.0	0.0	0.8
	MY	0.0	0.0	-0.1	-0.1	-0.1	-0.6	0.0	-0.6
	QX	0.0	0.0	-0.1	0.0	0.0	0.2	0.0	0.0
14	N	44.3	60.9	58.5	78.0	8.2	86.6	0.0	87.0
	MX	0.4	0.0	1.1	0.0	-0.6	1.9	0.0	1.1
	MY	-0.3	0.0	-0.7	0.0	0.4	-1.3	0.0	-1.2
	QX	1.0	1.5	-0.1	0.2	0.2	-1.7	0.0	0.1
ЯРУС 4 СЕЧЕНИЕ 2									
1	N	0.0	0.0	0.0	0.0	-0.5	0.0	0.0	0.0
	MX	0.1	0.1	0.1	0.1	0.0	0.0	0.0	-0.2
	MY	0.2	0.1	0.2	0.1	0.0	0.0	0.0	0.1
	QX	-0.1	-0.1	0.0	0.1	-0.1	0.0	0.0	0.0
8	N	0.0	0.0	0.0	0.0	-0.2	0.5	0.0	0.0
	MX	0.0	0.0	0.0	0.0	0.0	0.0	0.0	0.0
	MY	0.0	0.0	0.0	0.0	0.0	0.0	0.0	0.0
	QX	0.9	0.8	0.9	0.8	0.4	0.1	0.0	0.8
9	N	0.0	0.0	0.0	0.0	-6.3	0.0	0.0	0.0
	MX	0.0	0.0	0.0	0.0	0.2	0.9	0.0	1.0
	MY	0.0	0.0	0.0	0.1	0.1	0.6	0.0	0.6
	QX	0.0	0.0	-0.1	0.0	0.0	0.1	0.0	0.0
14	N	-44.3	-60.9	-58.5	-78.0	-8.2	-86.6	0.0	-87.0
	MX	0.6	0.0	1.2	0.0	-0.6	-2.5	0.0	-2.9
	MY	0.3	0.0	0.7	0.0	-0.4	-1.3	0.0	-1.2
	QX	0.8	1.2	0.2	0.2	0.3	-0.5	0.0	0.1

1.220.1-3Ж.0-1.4 27МУ4

ЛИСТ

4

МАРКА ПОЗ.	ОБОЗНАЧЕНИЕ	НАИМЕНОВАНИЕ	КОЛ	МАССА ЕД КГ	ПРИМЕЧАНИЕ
A3	I.220.I-3M.0-I.4 000	ДОКУМЕНТАЦИЯ ТЕХНИЧЕСКОЕ ОПИСАНИЕ СБОРОЧНЫЕ ЕДИНИЦЫ РИГЕЛЬ			
PI	I.220.I-3M.3-I 03-02	РДП.4.53-50	12	2518	
P2	I.220.I-3M.3-I 01-01	РДП.4.53-90АТУ	34	2518	
P9	I.220.I-3M.3-I 09	P4.57-20	28	1710	
PI0	I.020-I/83.3-I 07-01	РСП 4.57-30	20	2070	
PI2	I.020-I/83.3-I 02-02	РДП 4.57-60АТУ	14	2600	
PI3	I.04I.I-2.I.400-01 ПЕРЕМЕННЫЕ ДАННЫЕ	СВЯЗЕВАЯ ПЛИТА ПК56.15-6АТУС(АЛУ)Т-2 ДЛЯ ИСПОЛНЕНИЯ I.220.I-3M.0-I.4 28 3Т 6.7.30-ЗАЛ(2xI2) 40-2.5	19	2600	
Ф1	I.220.I-3M.I-I 04-01	РОСТВЕРК 2Ф3-40	4	3625	
Ф2	I.220.I-3M.I-I 03-01	ИФ3-40	22	3755	
Ф3	I.220.I-3M.I-I 02-01	Ф2-40	6	2575	
Ф4	I.220.I-3M.I-I 03-01	ИФ3-40	16	3755	
Ф6		ИФД9-40	2		
Ф8		ИФД9-40	2		
K1	I.220.I-3M.2-I I3-01	КОЛОННА КОЗТ 3.33-25.3	4	2428	
K2	I.220.I-3M.2-I I7-02	КОФЗТ 3.33-40.7	6	2414	
K3	I.220.I-3M.2-I II-04	КДЗТ 3.33-30.3	10	2496	
K4	I.220.I-3M.2-I I2	КДЗТ 3.33-40.4	3	2970	
K5	I.220.I-3M.2-I I2	КДЗТ 3.33-40.4	4	2970	
K6	I.220.I-3M.2-I I3-04	КОЗТ 3.33-30.3	4	2428	
I.220.I-3M.0-I.4 28					
НАЧ ОУД	Шевченко	ЗДАНИЕ 3Т 6.7-ЗАЛ(2xI2) 4Т 6.7-ЗАЛ(2xI2)	СГЛАДИЯ	ЛИСТ	ЛИСТОВ
НКОНТР.	Егоров		Р	1	6
ПДСПЕЦ	Руданж		ГОСГРАЖДАНСТРОЙ		
ПРОВЕРИЛ	Зуенко		КиевЗНИИЭП		
РАЗРАБ	Безуглова				

ФОРМАТ А 4

МАРКА ПОЗ.	ОБОЗНАЧЕНИЕ	НАИМЕНОВАНИЕ	КОЛ	МАССА ЕД КГ	ПРИМЕЧАНИЕ
K7	I.220.I-3M.2-I 09	КДЗТ 3.33-25.1	6	776	
K8	I.220.I-3M.2-I I3-04	КОЗТ 3.33-30.3	2	2428	
K9	I.220.I-3M.2-I I2	КДЗТ 3.33-40.4	3	2970	
K10	I.220.I-3M.2-I I3	КОЗТ 3.33-25.2	1	2373	
K11	I.220.I-3M.2-I I3	КОЗТ 3.33-25.2	3	2373	
K12	I.220.I-3M.2-I I2	КДЗТ 3.33-40.4	4	2970	
K13	I.220.I-3M.2-I I5-06	КДФЗТ 3.33-25.2	4	2396	
K14	I.220.I-3M.2-I I5-09	КДФЗТ 3.33-40.7	2	2490	
P3	I.020-I/83.3-I 07-02	РИГЕЛЬ РОП 4.57-40	32	2070	
P4	I.020-I/83.3-I 02-03	РДП 4.57-70АТУ	48	2600	
PII	I.04I.I-2.I.200-01	СВЯЗЕВАЯ ПЛИТА			
PI2	I.04I.I-2.I.400-02	ПК56.12-8АТУС(АЛУ)Т-1 ПК56.15-8АТУС(АЛУ)Т-2 I.220.I-3M.0-I.4 28-01 3Т 6.7.30-ЗАЛ(2xI2) 40-4.0	26 52	2000 2600	
Ф1	I.220.I-3M.I-I 04-01	РОСТВЕРК 2Ф3-40	4	3625	
Ф2	I.220.I-3M.I-I 03-01	ИФ3-40	22	3755	
Ф3	I.220.I-3M.I-I 02-01	Ф2-40	6	2575	
Ф4	I.220.I-3M.I-I 03-01	ИФ3-40	16	3755	
Ф6		ИФД9-40	2		
Ф8		ИФД9-40	2		
K1	I.220.I-3M.2-I I3	КОЛОННА КОЗТ 3.33-25.2	4	2373	
K2	I.220.I-3M.2-I I7-02	КОФЗТ 3.33-40.7	6	2414	
K3	I.220.I-3M.2-I II-01	КДЗТ 3.33-25.3	10	2496	
K4	I.220.I-3M.2-I II-01	КДЗТ 3.33-25.3	3	2496	
K5	I.220.I-3M.2-I II-01	КДЗТ 3.33-25.3	4	2496	
K6	I.220.I-3M.2-I I3	КОЗТ 3.33-25.2	4	2373	
K7	I.220.I-3M.2-I 09	КДЗТ 3.33-25.1	6	776	
K8	I.220.I-3M.2-I I3	КОЗТ 3.33-25.2	2	2373	
K9	I.220.I-3M.2-I II-01	КДЗТ 3.33-25.3	3	2496	
I.220.I-3M.0-I.4 28					ЛИСТ
					2

23171-04 126

ФОРМАТ А 4

МАРКА ПОЗ	ОБОЗНАЧЕНИЕ	НАИМЕНОВАНИЕ	КОЛ	МАССА ЕД КГ	ПРИМЕЧАНИЕ
K10	I.220.I-3M.2-I I3	КОЗТ 3.33-25.2	1	2373	
K11	I.220.I-3M.2-I I3	КОЗТ 3.33-25.2	3	2373	
K12	I.220.I-3M.2-I II-01	КДЗТ 3.33-25.3	4	2496	
K13	I.220.I-3M.2-I I5-06	КДФЗТ 3.33-25.2	4	2396	
K14	I.220.I-3M.2-I I5-09	КДФЗТ 3.33-40.7	2	2490	
		РИГЕЛЬ			
P3	I.020-I/83.3-I 07-02	РОП 4.57-40	32	2070	
P4	I.020-I/83.3-I 02-03	РДП 4.57-70АТУ	48	2600	
		СВЯЗЕВАЯ ПЛИТА			
P11	I.04I.I-2.I.200-0I	ПК56.I2-8АТИУС(АЛУ)Т-1	26	2000	
P12	I.04I.I-2.I.400-02	ПК56.I5-8АТИУС(АЛУ)Т-2	522	2600	
		I.220.I-3M.0-I.4 28-02			
		4Т 6.7.30-ЗАЛ(2xI2)			
		40-2.5			
		РОСТВЕРК			
Ф1	I.220.I-3M.I-I 04-0I	2Ф3-40	4	3625	
Ф2	I.220.I-3M.I-I 03-0I	ИФ3-40	22	3755	
Ф3	I.220.I-3M.I-I 02-0I	Ф2-40	6	2575	
Ф4	I.220.I-3M.I-I 05-0I	Ф4-40	16	4100	
Ф6		ИФДП-40	2		
Ф8		ИФДП-40	2		
		КОЛОННА			
K1	I.220.I-3M.2-I I8-0I	КО4Т 3.33-40.2	4	3179	
K2	I.220.I-3M.2-I 24-03	КОФ4Т 3.33-40.7	6	3248	
K3	I.220.I-3M.2-I I8-05	КД4Т 3.33-40.3	10	3343	
K4	I.220.I-3M.2-I 20-0I	КД4Т 3.33-40.6	3	3394	
K5	I.220.I-3M.2-I 20-0I	КД4Т 3.33-40.6	4	3394	
K6	I.220.I-3M.2-I I8-02	КО4Т 3.33-40.3	4	3252	
K7	I.220.I-3M.2-I I0-0I	КД2Т 3.33-25.2	6	1613	
K8	I.220.I-3M.2-I I8-02	КО4Т 3.33-40.3	2	3252	
K9	I.220.I-3M.2-I 20-0I	КД4Т 3.33-40.6	3	3394	
K10	I.220.I-3M.2-I I8	КО4Т 3.33-30.2	1	3179	
K11	I.220.I-3M.2-I I8	КО4Т 3.33-30.2	3	3179	
K12	I.220.I-3M.2-I 20-0I	КДФ4Т 3.33-40.6	4	3394	
I.220.I-3M.0-I.4 28					ЛИСТ 3

ФОРМАТ А 4

МАРКА ПОЗ	ОБОЗНАЧЕНИЕ	НАИМЕНОВАНИЕ	КОЛ	МАССА ЕД КГ	ПРИМЕЧАНИЕ
K13	I.220.I-3M.2-I 27	КДФ4Т 3.33-30.2	4	3224	
K14	I.220.I-3M.2-I 27-03	КДФ4Т 3.33-40.7	2	3346	
		РИГЕЛЬ			
P3	I.020-I/83.3-I 07-02	ВОП 4.57-40	44	2070	
P4	I.020-I/83.3-I 02-03	РДП 4.57-70АТУ	82	2600	
		СВЯЗЕВАЯ ПЛИТА			
P11	I.04I.I-2.I.200-0I	ПК56.I2-8АТИУС(АЛУ)Т-1	40	2000	
P12	I.04I.I-2.I.400-02	ПК56.I5-8АТИУС(АЛУ)Т-2	85	2600	
		I.220.I-3M.0-I.4 28-03			
		4Т 6.7.30-ЗАЛ(2xI2)			
		40-4.0			
		РОСТВЕРК			
Ф1	I.220.I-3M.I-I 04-0I	2Ф3-40	4	3625	
Ф2	I.220.I-3M.I-I 03-0I	ИФ3-40	22	3755	
Ф3	I.220.I-3M.I-I 02-0I	Ф2-40	6	2575	
Ф4	I.220.I-3M.I-I 05-0I	Ф4-40	16	4100	
Ф6		ИФДП-40	2		
Ф8		ИФДП-40	2		
		КОЛОННА			
K1	I.220.I-3M.2-I I8	КО4Т 3.33-30.2	4	3179	
K2	I.220.I-3M.2-I 24-03	КОФ4Т 3.33-40.7	6	3248	
K3	I.220.I-3M.2-I I8-04	КД4Т 3.33-40.2	10	3269	
K4	I.220.I-3M.2-I I8-05	КД4Т 3.33-40.3	3	3343	
K5	I.220.I-3M.2-I I8-05	КД4Т 3.33-40.3	4	3343	
K6	I.220.I-3M.2-I I8-0I	КО4Т 3.33-40.2	4	3179	
K7	I.220.I-3M.2-I I0-0I	КД2Т 3.33-25.2	6	1613	
K8	I.220.I-3M.2-I I8-0I	КО4Т 3.33-40.2	2	3179	
K9	I.220.I-3M.2-I I8-05	КД4Т 3.33-40.3	3	3343	
K10	I.220.I-3M.2-I I8	КО4Т 3.33-30.2	1	3179	
K11	I.220.I-3M.2-I I8	КО4Т 3.33-30.2	3	3179	
K12	I.220.I-3M.2-I I8-05	КД4Т 3.33-40.3	4	3343	
K13	I.220.I-3M.2-I 27	КДФ4Т 3.33-40.2	4	3224	
K14	I.220.I-3M.2-I 27-03	КДФ4Т 3.33-40.7	2	3346	
I.220.I-3M.0-I.4 28					ЛИСТ 4

231 71-04 127

ФОРМАТ А 4

МАРКА ПОЗ	ОБОЗНАЧЕНИЕ	НАИМЕНОВАНИЕ	КОЛ	МАССА ЕД КГ	ПРИМЕЧАНИЕ
		РИГЕЛЬ			
P3	I.020-I/83.3-I 07-02	РОП 4.57-40	44	2070	
P4	I.020-I/83.3-I 02-03	РДП 4.57-70АТУ	82	2600	
		СВЯЗЕВАЯ ПЛИТА			
РП1	I.04I.I-2.I.200-0I	ПК56.I2-8АТIУС(АIУ)Т-I	40	2000	
РП2	I.04I.I-2.I.400-02	ПК56.I5-8АТIУС(АIУ)Т-2	85	2600	
		I.220.I-3M.O-I.4 28-04 4Т 6.7.30-3АЛ(2xI2) 3x32-3.5			
		РОСТВЕРК			
Ф1	I.220.I-3M.I-I 04	2Ф3-32	4	4275	
Ф2	I.220.I-3M.I-I 03	1Ф3-32	22	4390	
Ф3	I.220.I-3M.I-I 02	Ф2-32	6	2650	
Ф4	I.220.I-3M.I-I 05	Ф4-32	16	4775	
Ф6		1ФДII-32	2		
Ф8		1ФДII-32	2		
		КОЛОННА			
K1	I.220.I-3M.2-I 18	КО4Т 3.33-30.2	4	3179	
K2	I.220.I-3M.2-I 24-03	КОФ4Т 3.33-40.7	6	3248	
K3	I.220.I-3M.2-I 18-04	КД4Т 3.33-40.2	10	3269	
K4	I.220.I-3M.2-I 18-04	КД4Т 3.33-40.2	3	3269	
K5	I.220.I-3M.2-I 18-04	КД4Т 3.33-40.2	4	3269	
K6	I.220.I-3M.2-I 18-0I	КО4Т 3.33-40.2	4	3179	
K7	I.220.I-3M.2-I 10	КЛ2Т 3.33-25.1	6	1592	
K8	I.220.I-3M.2-I 18-0I	КО4Т 3.33-40.2	2	3179	
K9	I.220.I-3M.2-I 18-04	КД4Т 3.33-40.2	3	3269	
K10	I.220.I-3M.2-I 18	КО4Т 3.33-30.2	1	3179	
K11	I.220.I-3M.2-I 18	КО4Т 3.33-30.2	3	3179	
K12	I.220.I-3M.2-I 18-04	КД4Т 3.33-40.2	4	3269	
K13	I.220.I-3M.2-I 27	КЛФ4Т 3.33-30.2	4	3224	
K14	I.220.I-3M.2-I 27-03	КДФ4Т 3.33-40.7	2	3346	
		РИГЕЛЬ			
P3	I.020-I/83.3-I 07-02	РОП 4.57-40	44	2070	
P4	I.020-I/83.3-I 02-03	РДП 4.57-70АТУ	82	2600	
		I.220.I-3M.O-I.4 28			
					ЛИСТ 5

ФОРМАТ А4

МАРКА ПОЗ	ОБОЗНАЧЕНИЕ	НАИМЕНОВАНИЕ	КОЛ	МАССА ЕД КГ	ПРИМЕЧАНИЕ
		СВЯЗЕВАЯ ПЛИТА			
РП1	I.04I.I-2.I.200-0I	ПК56.I2-8АТIУС(АIУ)Т-I	40	2000	
РП2	I.04I.I-2.I.400-02	ПК56.I5-8АТIУС(АIУ)Т-2	85	2600	
		I.220.I-3M.O-I.4 28			
					ЛИСТ 6

ОПЕРАТОР
СИСТЕМЫ

САПР
К.И.Е.Э.И.И.Э.П.

ИМЯ И ПОДПИСЬ И ДАТА

ВЗАИМН.ИМЯ

23171-04 128

ФОРМАТ А4

0285 -

КиевЗНИИЭП

МОНТАЖНЫЙ ПЛАН РОСТВЕРКОВ

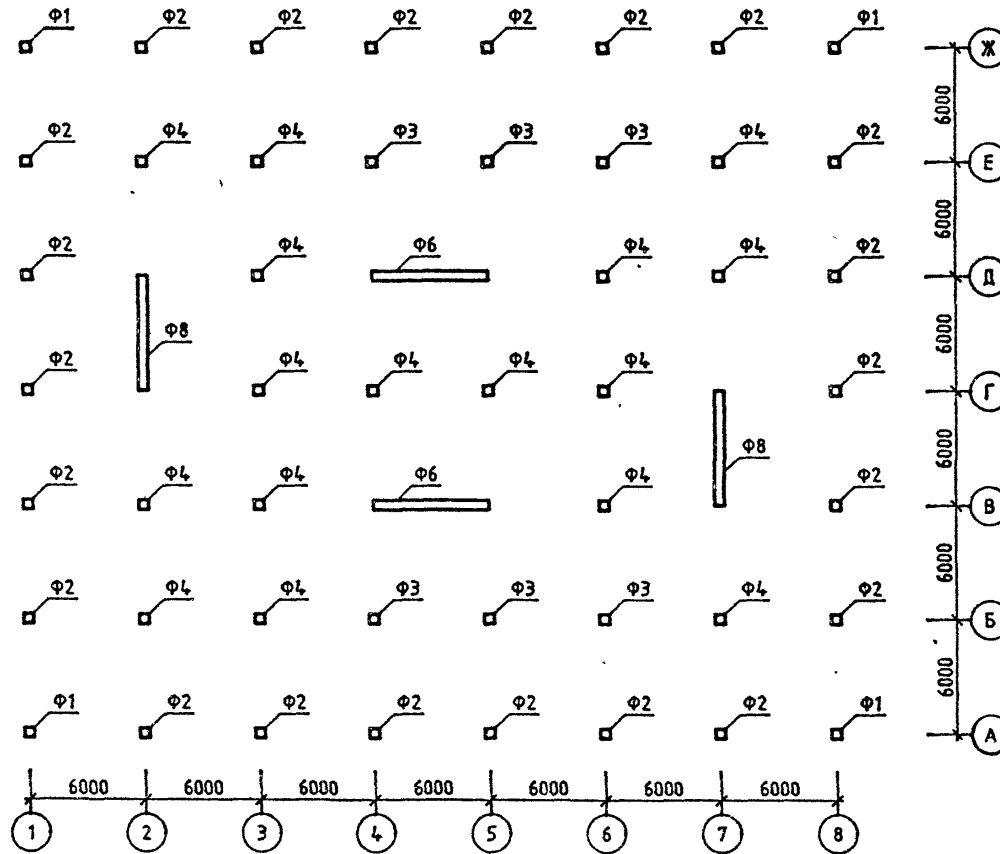

ОБОЗНАЧЕНИЕ	ШИФР ЗДАНИЯ
1.220.1-3М.0-1.4 28	ЭТ 6.7.30-ЗАЛ(2*12)4.0-2.5
-01	ЭТ 6.7.30-ЗАЛ(2*12)4.0-4.0
-02	4Т 6.7.30-ЗАЛ(2*12)4.0-2.5
-03	4Т 6.7.30-ЗАЛ(2*12)4.0-4.0
-04	4Т 6.7.30-ЗАЛ(2*12)3*32-3.5

Нач. отд.	Шевченко	<i>[Signature]</i>
ГИП	Егузов	<i>[Signature]</i>
НКОНТР.	Зуенко	<i>[Signature]</i>
ПРОВЕРИЛ	Бойко	<i>[Signature]</i>
РАЗРАБ	Рудавий	<i>[Signature]</i>

1.220.1-3М.0-1.4 28СБ

ЗДАНИЕ
ЭТ 6.7-ЗАЛ(2*12)
4Т 6.7-ЗАЛ(2*12)

СТАДИЯ	ЛИСТ	ЛИСТОВ
Р	1	6

ГОСГРАЖДАНСТРОЙ
КиевЗНИИЭП

МОНТАЖНЫЙ ПЛАН КОЛОНН

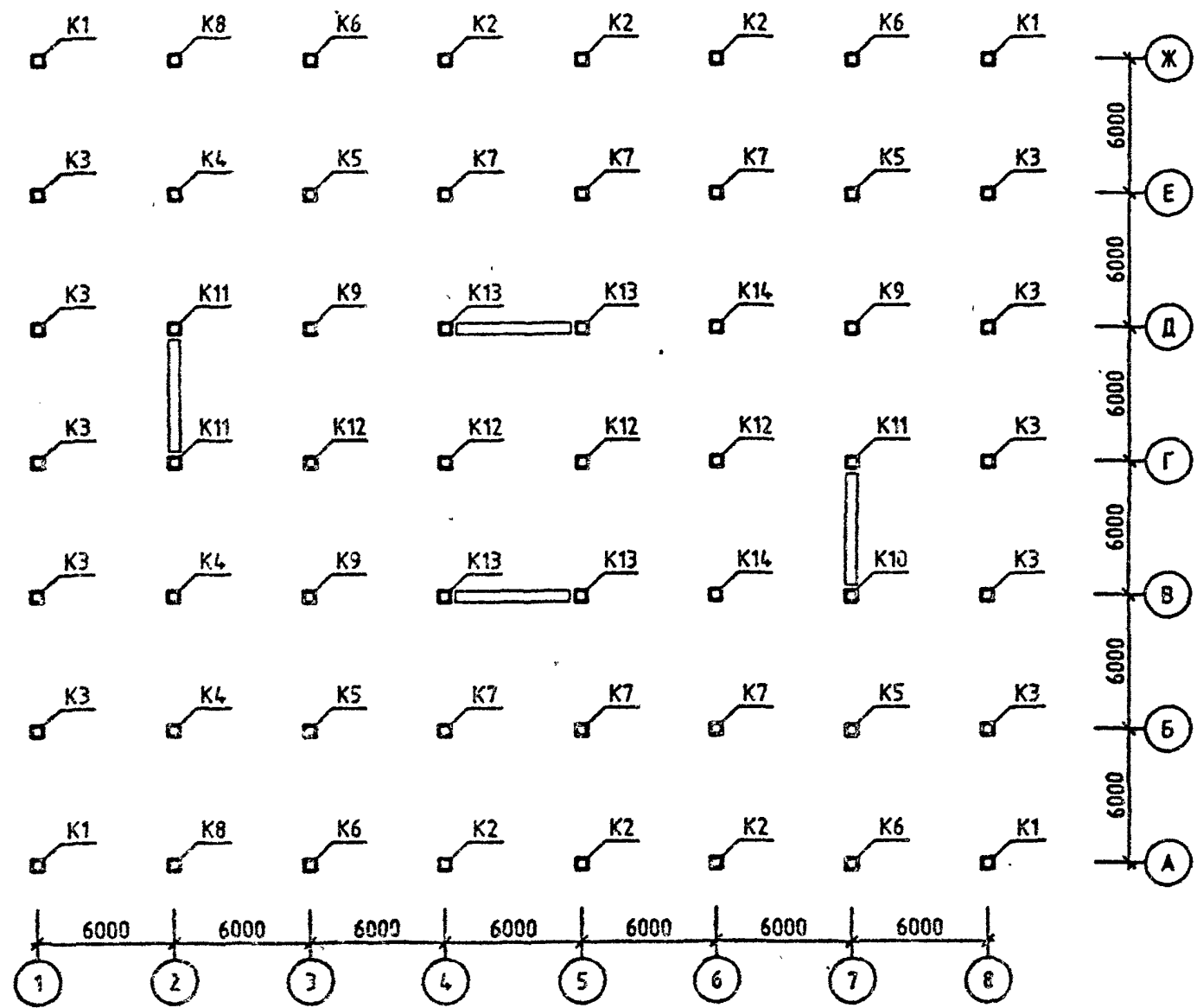

1.220.1-3М.0-1.4 28СБ

ЛИСТ
2

МОНТАЖНЫЙ ПЛАН РИГЕЛЕЙ

ОТМ. -2.32

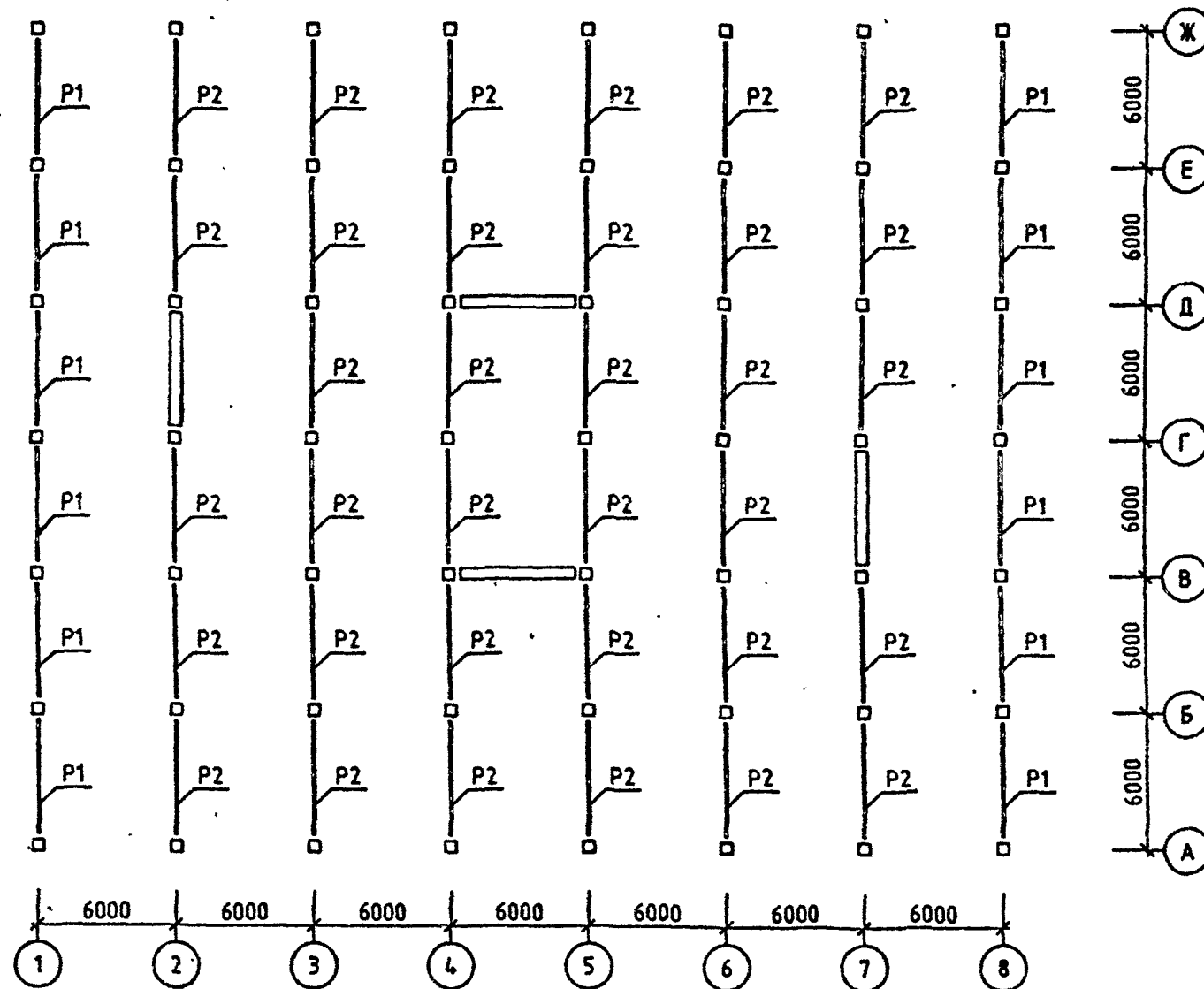

1.220.1-3М.0-1.4 280Б

ЛИСТ
3

23171-04 131
ФОРМАТ А3

МОНТАЖНЫЙ ПЛАН РИГЕЛЕЙ И СВЯЗЕВЫХ ПЛИТ

ОТМ. -0.10 (+3.20)

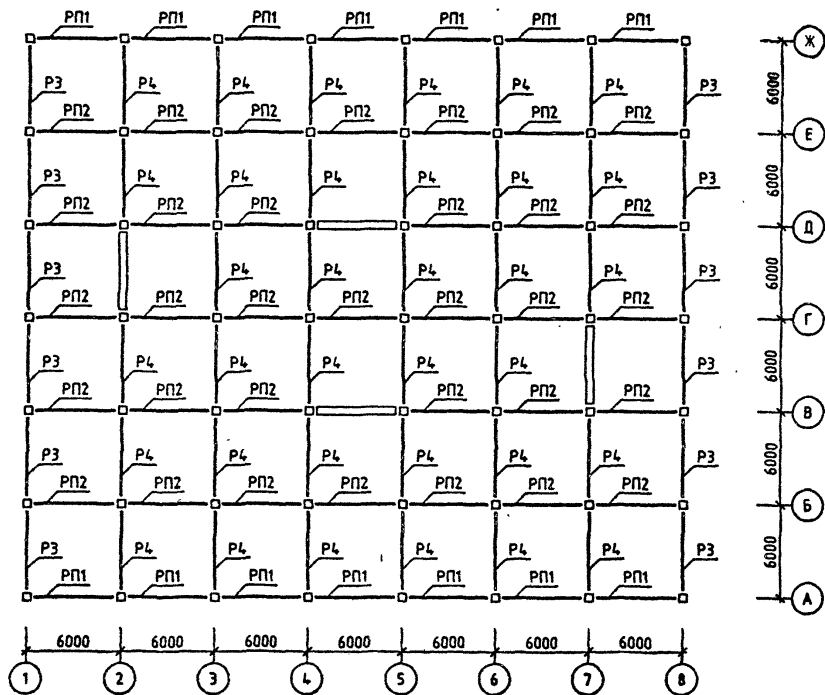

1.220.1-3М.0-1.4 2805

ЛИСТ

4

23171-04 132
ФОРМАТ А3

МОНТАЖНЫЙ ПЛАН РИГЕЛЕЙ И СВЯЗЕВЫХ ПЛИТ
 ОТМ. +3.20 (+6.50)

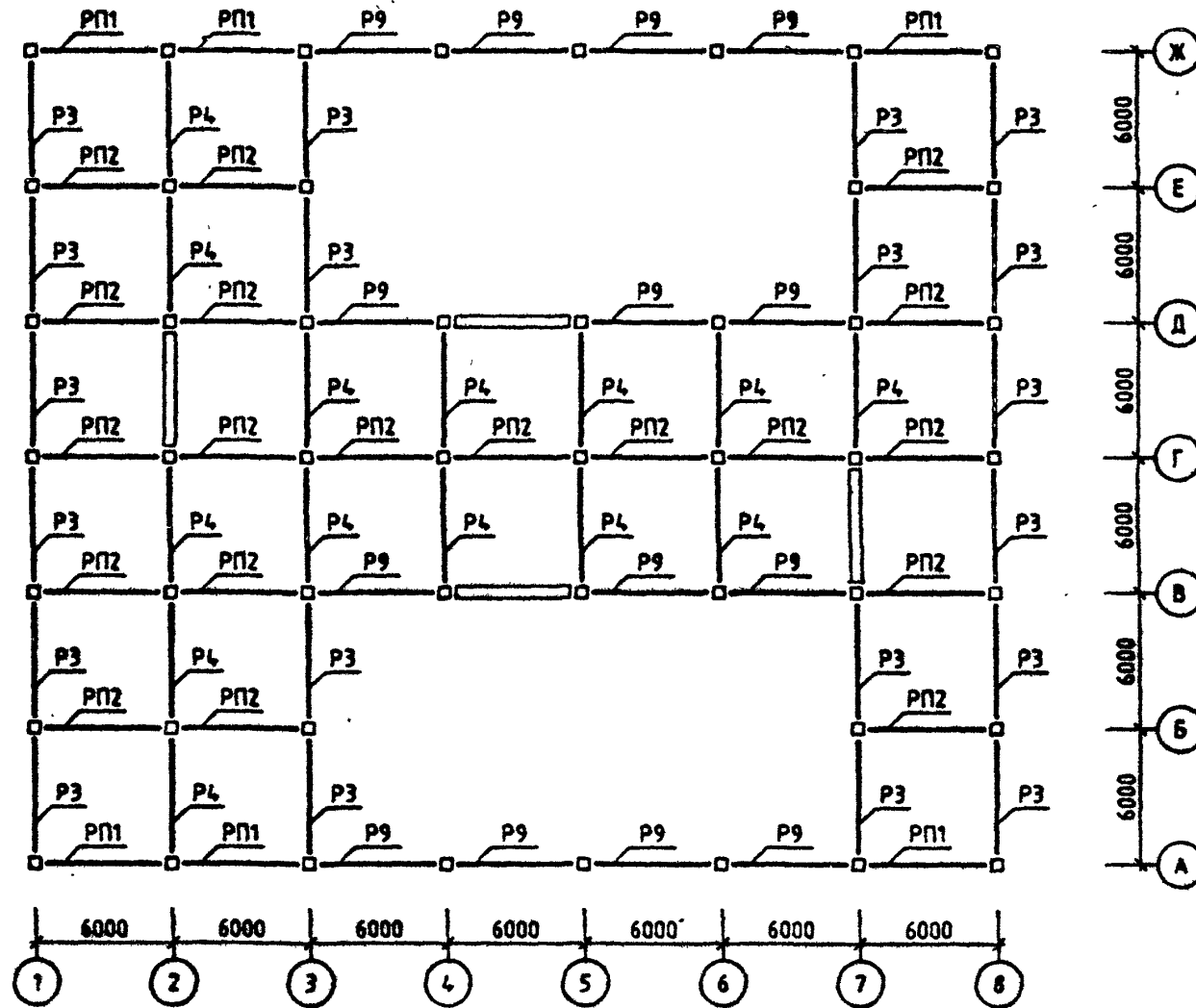

МОНТАЖНЫЙ ПЛАН РИГЕЛЕЙ И СВЯЗЕВЫХ ПЛИТ
 ОТМ. +6.50 (+9.80)

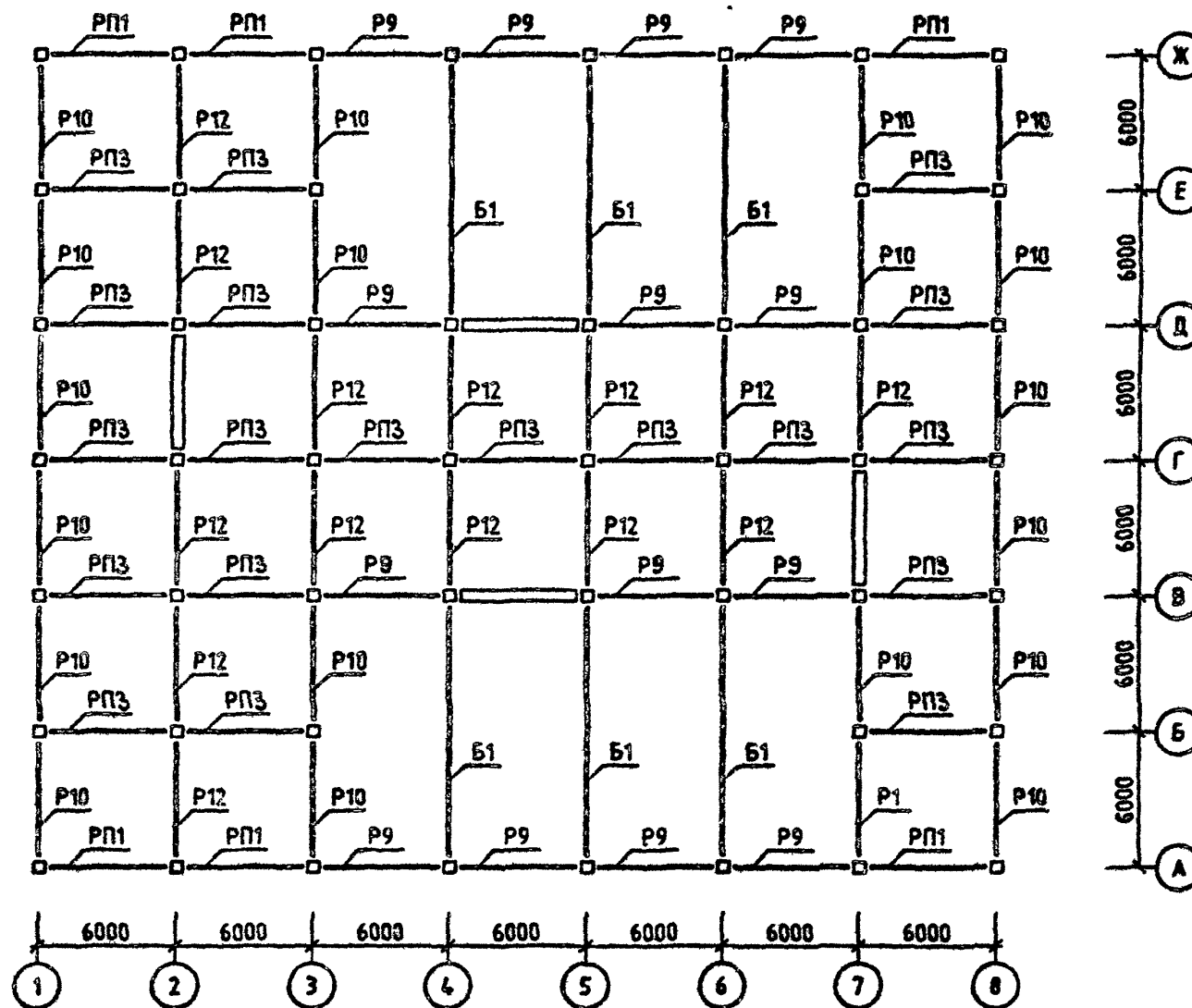

1.220.1-3М.0-1.4 280Б

ЛИСТ
6

23171-04 134
 ФОРМАТ А3

Номер загрузки	Тип усилия	Номер группы элементов							
		1	2	3	4	5	6	7	8
ЯРУС 1 СЕЧЕНИЕ 1									
1	N	0.0	0.0	0.0	0.0	-17.3	-17.9	0.0	0.0
	MX	9.7	11.0	15.3	15.5	43.0	11.2	6.9	13.1
	QU	-2.8	-2.9	-4.1	-4.0	-33.2	-3.3	-1.4	-3.3
	MU	-10.5	-16.6	-12.4	-17.5	-25.9	-40.1	-5.3	-7.9
	QX	-2.6	-4.0	-2.6	-3.8	7.4	-21.9	-0.8	-1.4
8	N	0.0	0.0	0.0	0.0	0.0	-23.0	0.0	0.0
	MX	0.0	0.0	0.0	0.0	0.0	0.0	0.0	0.0
	QU	0.0	0.0	0.0	0.0	0.0	0.0	0.0	0.0
	MU	-0.3	-0.6	-0.5	-0.8	-1.3	-7.9	-0.4	-0.5
	QX	-0.1	-0.1	-0.1	-0.2	-0.3	-6.4	-0.1	-0.1
9	N	0.0	0.0	0.0	0.0	-26.8	0.0	0.0	0.0
	MX	0.4	0.7	0.7	1.1	9.3	1.6	0.5	-0.1
	QU	-0.1	-0.2	-0.2	-0.3	-7.6	-0.4	-0.1	0.2
	MU	0.0	0.0	0.0	0.0	0.0	0.0	0.0	0.0
	QX	0.0	0.0	0.0	0.0	0.0	0.0	0.0	0.0
14	N	94.5	127.1	122.3	160.4	125.5	120.7	82.4	117.4
	MX	0.3	0.0	0.6	-0.7	4.4	0.1	0.1	2.4
	QU	-0.4	0.0	-1.1	0.2	-4.8	-0.1	0.0	-1.8
	MU	-0.7	-0.8	-0.1	-0.2	-0.2	4.8	0.0	-0.1
	QX	-0.9	1.4	0.0	0.0	0.1	-5.2	0.0	0.0
ЯРУС 1 СЕЧЕНИЕ 2									
1	N	0.0	0.0	0.0	0.0	17.3	17.9	0.0	0.0
	MX	-2.8	-3.7	-5.0	-5.5	40.0	-2.9	-3.4	-4.9
	QU	2.8	2.9	4.1	4.0	33.2	3.3	1.4	3.3
	MU	3.1	5.6	4.2	6.3	7.2	-37.8	2.6	2.7
	QX	2.6	4.0	2.6	3.8	-7.4	21.9	0.8	1.4
8	N	0.0	0.0	0.0	0.0	0.0	23.0	0.0	0.0
	MX	0.0	0.0	0.0	0.0	0.0	0.0	0.0	0.0
	QU	0.0	0.0	0.0	0.0	0.0	0.0	0.0	0.0
	MU	0.1	0.2	0.2	0.3	0.5	-8.1	0.2	0.2
	QX	0.1	0.1	0.1	0.2	0.3	6.4	0.1	0.1
9	N	0.0	0.0	0.0	0.0	26.8	0.0	0.0	0.0
	MX	-0.1	-0.2	-0.3	-0.4	9.6	-0.6	-0.3	-0.3
	QU	0.1	0.2	0.2	0.3	7.6	0.4	0.1	-0.2
	MU	0.0	0.0	0.0	0.0	0.0	0.0	0.0	0.0
	QX	0.0	0.0	0.0	0.0	0.0	0.0	0.0	0.0
14	N	-94.5	-127.1	-122.3	-160.4	-125.5	-120.7	-82.4	-117.4
	MX	-0.8	0.0	-2.1	-0.1	7.6	-0.1	0.0	-2.1
	QU	-0.4	0.0	-1.1	0.2	4.8	-0.1	0.0	-1.8
	MU	-1.5	2.6	0.0	0.0	0.0	8.3	0.0	0.0
	QX	-0.8	-1.4	0.0	0.0	-0.1	-5.2	0.0	0.0

1.220.1-3М.0-1.4 28МУ

ГИП	Егунов	
Н КОНТР.	Бойко	
РУК.ГР.	Рудакин	
ПРОВЕРИЛ	Футорная	
РАЗРАБ	Зуенко	

ЗДАНИЕ
3Т 6.7.30-ЗАЛ(2*12)40-2.5

СТАДИЯ	ЛИСТ	ЛИСТОВ
Р	1	3
ГОСГРАЖДАНСТРОЙ КиевЗНИИЭП		

Номер загрузки	Тип усилия	Номер группы элементов							
		1	2	3	4	5	6	7	8
ЯРУС 2 СЕЧЕНИЕ 1									
1	N	0.0	0.0	0.0	0.0	-9.5	-11.6	0.0	0.0
	MX	7.8	3.7	5.0	5.5	-0.5	1.6	3.4	4.9
	QU	-2.8	-2.9	-4.1	-4.0	0.3	-1.5	-1.4	-3.3
	MU	-3.1	-5.6	-4.2	-6.3	-3.6	0.5	-2.6	-2.7
	QX	-2.6	-4.0	-2.6	-3.8	3.2	0.3	-0.8	-1.4
8	N	0.0	0.0	0.0	0.0	0.0	-8.0	0.0	0.0
	MX	0.0	0.0	0.0	0.0	0.0	0.0	0.0	0.0
	QU	0.0	0.0	0.0	0.0	0.0	0.0	0.0	0.0
	MU	-0.1	-0.2	-0.2	-0.3	-0.2	-0.2	-0.2	-0.2
	QX	-0.1	-0.1	-0.1	-0.2	-0.1	-0.2	-0.1	-0.1
9	N	0.0	0.0	0.0	0.0	-9.3	0.0	0.0	0.0
	MX	0.1	0.2	0.3	0.4	0.3	0.2	0.3	0.3
	QU	-0.1	-0.2	-0.2	-0.3	-0.2	-0.2	-0.1	0.2
	MU	0.0	0.0	0.0	0.0	0.0	0.0	0.0	0.0
	QX	0.0	0.0	0.0	0.0	0.0	0.0	0.0	0.0
14	N	67.0	93.2	89.5	122.1	50.7	48.0	44.1	84.7
	MX	0.6	0.0	1.2	0.1	0.4	-0.1	0.0	1.1
	QU	-0.4	0.0	-1.0	-0.2	-0.1	0.1	0.0	-1.8
	MU	1.0	-1.5	0.0	0.0	0.0	-0.4	0.0	0.0
	QX	0.8	1.4	0.0	0.0	0.0	-0.1	0.0	0.0
ЯРУС 2 СЕЧЕНИЕ 2									
1	N	0.0	0.0	0.0	0.0	9.5	11.6	0.0	0.0
	MX	3.9	3.3	-4.7	-4.0	-0.3	1.9	0.0	2.9
	QU	2.8	2.9	-4.1	-4.0	-0.3	1.5	-1.2	3.3
	MU	4.0	4.9	3.5	4.3	-4.2	0.3	0.0	-2.2
	QX	2.6	4.0	-2.6	-3.8	-3.2	-0.3	0.5	1.4
8	N	0.0	0.0	0.0	0.0	0.0	8.0	0.0	0.0
	MX	0.0	0.0	0.0	0.0	0.0	0.0	0.0	0.0
	QU	0.0	0.0	0.0	0.0	0.0	0.0	0.0	0.0
	MU	-0.1	-0.1	-0.1	-0.2	-0.1	-0.2	0.0	-0.1
	QX	0.1	0.1	0.1	0.2	0.1	0.2	0.1	0.1
9	N	0.0	0.0	0.0	0.0	9.3	0.0	0.0	0.0
	MX	0.1	0.2	0.2	0.2	0.2	0.2	0.0	-0.6
	QU	0.1	0.2	0.2	0.3	0.2	0.2	0.1	-0.2
	MU	0.0	0.0	0.0	0.0	0.0	0.0	0.0	0.0
	QX	0.0	0.0	0.0	0.0	0.1	0.0	0.0	0.0
14	N	-67.0	-93.2	-89.5	-122.1	-50.7	-48.0	-44.1	-84.7
	MX	-0.5	0.0	-1.4	-0.5	0.1	-0.2	0.0	-3.2
	QU	-0.4	0.0	-1.1	-0.2	0.0	-0.1	0.0	-1.8
	MU	-1.1	-1.8	-0.1	-0.1	-0.1	-0.1	0.0	0.0
	QX	-0.8	-1.4	0.0	0.0	0.0	0.1	0.0	0.0

Безлюдова
Оператор системы
САПР КиевЗНИИЭП

ВЗЯМ ИВБ №
ПОДПИСЬ И ДАТА

1.220.1-3М.0-1.4 28МУ

ЛИСТ
2

Номер загрузки	Тип усилия	Номер группы элементов							
		1	2	3	4	5	6	7	8
ЯРУС 3 СЕЧЕНИЕ 1									
1	N	0.0	0.0	0.0	0.0	-3.1	-3.8	0.0	0.0
	MX	-3.9	-3.3	4.7	4.0	-0.1	-1.3	0.0	-2.9
	QY	1.4	1.2	-1.7	-1.5	0.1	0.6	0.0	0.4
	MY	-4.0	-4.9	-3.5	-4.3	2.7	0.1	0.0	2.2
	QX	1.3	1.6	-1.1	-1.4	-1.1	0.1	0.0	0.6
8	N	0.0	0.0	0.0	0.0	0.0	-4.4	0.0	0.0
	MX	0.0	0.0	0.0	0.0	0.0	0.0	0.0	0.0
	QY	0.0	0.0	0.0	0.0	0.0	0.0	0.0	0.0
	MY	0.1	0.1	0.1	0.2	0.1	-0.1	0.0	0.1
	QX	0.0	0.0	0.0	0.0	0.0	-0.1	0.0	0.0
9	N	0.0	0.0	0.0	0.0	5.1	0.0	0.0	0.0
	MX	-0.1	-0.2	-0.2	-0.2	0.2	-0.1	0.0	0.6
	QY	0.1	0.1	0.1	0.1	-0.1	0.1	0.0	-0.5
	MY	0.0	0.0	0.0	0.0	0.0	0.0	0.0	0.0
	QX	0.0	0.0	0.0	0.0	0.0	0.0	0.0	0.0
14	N	44.3	60.9	58.5	78.0	21.3	17.3	0.0	53.6
	MX	0.4	0.0	-0.9	0.5	-0.5	0.2	0.0	1.2
	QY	-0.3	0.0	0.6	-0.6	0.4	-0.2	0.0	-1.2
	MY	0.9	1.3	0.1	0.1	0.1	-0.4	0.0	0.0
	QX	0.5	0.7	0.0	0.0	0.1	0.3	0.0	0.0
ЯРУС 3 СЕЧЕНИЕ 2									
1	N	0.0	0.0	0.0	0.0	3.1	3.8	0.0	0.0
	MX	0.8	-10.6	1.0	0.8	-0.1	-0.6	0.0	1.5
	QY	1.2	-11.2	1.7	1.5	-0.1	-0.6	0.0	-0.4
	MY	-0.7	-10.9	-0.5	0.8	1.0	0.1	0.0	0.3
	QX	-1.3	-11.6	0.6	1.4	1.1	-0.1	0.0	-0.6
8	N	0.0	0.0	0.0	0.0	0.0	4.4	0.0	0.0
	MX	0.0	0.0	0.0	0.0	0.0	0.0	0.0	0.0
	QY	0.0	0.0	0.0	0.0	0.0	0.0	0.0	0.0
	MY	0.0	0.0	0.0	0.0	0.0	-0.1	0.0	-0.1
	QX	0.0	0.0	0.0	0.0	0.0	0.1	0.0	0.0
9	N	0.0	0.0	0.0	0.0	-5.1	0.0	0.0	0.0
	MX	-0.0	-10.1	-0.1	-0.1	0.1	-0.1	0.0	1.1
	QY	0.1	10.1	-0.1	-0.1	0.1	-0.1	0.0	0.5
	MY	0.0	0.0	0.0	0.0	0.0	0.0	0.0	0.0
	QX	0.0	0.0	0.0	0.0	0.0	0.0	0.0	0.0
14	N	44.3	60.9	58.5	78.0	21.3	17.3	0.0	53.6
	MX	-0.5	0.0	-1.2	-1.7	-0.7	-0.5	0.0	-2.9
	QY	-0.3	0.0	-0.6	-0.6	-0.4	-0.2	0.0	-1.2
	MY	0.7	1.3	0.1	0.2	0.1	-0.5	0.0	0.1
	QX	-0.5	0.7	0.0	0.0	-0.1	-0.3	0.0	0.0

ФОРМАТ А4

Номер загрузки	Тип усилия	Номер группы элементов							
		1	2	3	4	5	6	7	8
ЯРУС 1 СЕЧЕНИЕ 1									
1	N	0.0	0.0	0.0	0.0	-21.4	-20.3	0.0	0.0
	MX	6.1	7.4	10.4	11.9	22.4	7.4	4.9	9.1
	QY	-1.3	-1.5	-2.1	-2.3	-11.1	-1.7	-0.8	-1.7
	MY	-6.7	-11.5	-8.6	-13.9	-17.7	-18.7	-3.8	-5.5
	QX	-1.3	-2.1	-1.4	-2.3	4.0	-7.1	-0.5	-0.8
8	N	0.0	0.0	0.0	0.0	0.0	-24.6	0.0	0.0
	MX	0.0	0.0	0.0	0.0	0.0	0.0	0.0	0.0
	QY	0.0	0.0	0.0	0.0	0.0	0.0	0.0	0.0
	MY	-0.7	-1.3	-1.2	-2.2	-2.8	-11.2	-1.0	-1.2
	QX	-0.1	-0.2	-0.2	-0.4	-0.6	-5.5	-0.2	-0.2
9	N	0.0	0.0	0.0	0.0	-28.7	0.0	0.0	0.0
	MX	0.9	1.6	1.6	2.6	13.2	3.3	1.2	0.9
	QY	-0.2	-0.3	-0.3	-0.5	-6.5	-0.7	-0.2	-0.1
	MY	0.0	0.0	0.0	0.0	0.0	0.1	0.0	0.0
	QX	0.0	0.0	0.0	0.0	0.0	0.0	0.0	0.0
14	N	94.5	127.1	122.3	160.4	139.1	135.1	82.4	117.4
	MX	0.5	0.0	1.4	-0.6	3.4	-0.1	0.0	1.0
	QY	-0.4	0.0	-0.9	0.2	-2.4	0.1	0.0	-1.4
	MY	-1.1	-1.8	-0.1	-0.1	-0.1	3.7	0.0	0.0
	QX	-0.7	1.2	0.0	0.0	0.0	-2.6	0.0	0.0
ЯРУС 1 СЕЧЕНИЕ 2									
1	N	0.0	0.0	0.0	0.0	21.4	20.3	0.0	0.0
	MX	-0.7	-1.4	-2.0	-2.8	22.0	-0.5	-1.8	-2.2
	QY	1.3	1.5	2.1	2.3	11.1	1.7	0.8	1.7
	MY	0.9	2.3	1.7	3.3	1.4	-18.8	1.4	1.1
	QX	1.3	2.1	1.4	2.3	-4.0	7.1	0.5	0.8
8	N	0.0	0.0	0.0	0.0	0.0	24.6	0.0	0.0
	MX	0.0	0.0	0.0	0.0	0.0	0.0	0.0	0.0
	QY	0.0	0.0	0.0	0.0	0.0	0.0	0.0	0.0
	MY	0.1	0.3	0.3	0.5	0.4	-10.9	0.4	0.3
	QX	0.1	0.2	0.2	0.4	0.6	5.5	0.2	0.2
9	N	0.0	0.0	0.0	0.0	28.7	0.0	0.0	0.0
	MX	-0.7	-0.3	-0.3	-0.6	12.9	-0.4	-0.4	-0.5
	QY	0.2	0.3	0.3	0.5	6.5	0.7	0.2	0.1
	MY	0.0	0.0	0.0	0.0	0.0	0.1	0.0	0.0
	QX	0.0	0.0	0.0	0.0	0.0	0.0	0.0	0.0
14	N	-94.5	-127.1	-122.3	-160.4	-139.1	-135.1	-82.4	-117.4
	MX	-0.9	0.0	-2.3	0.0	6.2	-0.2	0.0	-2.8
	QY	-0.4	0.0	-0.9	-0.2	2.4	-0.1	0.0	-1.4
	MY	-1.7	-2.9	0.0	0.0	0.0	6.7	0.0	0.0
	QX	-0.7	-1.2	0.0	0.0	0.0	2.6	0.0	0.0

Безупречно
ОПЕРАТОР СИСТЕМЫ
САПР КиевЗНИИЭП

ПОДПИСЬ И ДАТА		ВЗАМ ИВБ №		1.220.1-3М.0-1.4 28МУ		
ИВБ № ПОДЛ	ГИП	Егузов	ИВБ №	СТАДИЯ	ЛИСТ	ЛИСТОВ
	И КОНТР	Бойко	ИВБ №	Р	1	3
	РУК ГР	Рудвин	ИВБ №	ЗДАНИЕ		
	ПРОВЕРИЛ	Футормая	ИВБ №	ЗТ 6.7.30-ЗАЛ(2*12)40-4.0		
	РАЗРАБ	Зуемко	ИВБ №	КиевЗНИИЭП		

Номер загрузки	Тип усиления	Номер группы элементов							
		1	2	3	4	5	6	7	8
ЯРУС 2 СЕЧЕНИЕ 1									
1	N	0.0	0.0	0.0	0.0	2.8	2.0	0.0	0.0
	MX	0.7	1.4	2.0	2.8	-0.4	0.7	1.8	2.2
	QY	-1.3	-1.5	-2.1	-2.3	0.3	-0.8	-0.8	-1.7
	MU	-0.9	-2.3	-1.7	-3.3	-1.7	0.3	-1.4	-1.1
	QX	-1.3	-2.1	-1.4	-2.3	1.8	0.2	-0.5	-0.8
8	N	0.0	0.0	0.0	0.0	0.0	-6.9	0.0	0.0
	MX	0.0	0.0	0.0	0.0	0.0	0.0	0.0	0.0
	QY	0.0	0.0	0.0	0.0	0.0	0.0	0.0	0.0
	MU	-0.1	-0.3	-0.3	-0.5	-0.3	-0.1	-0.4	-0.3
	QX	-0.1	-0.2	-0.2	-0.4	-0.3	-0.1	-0.2	-0.2
9	N	0.0	0.0	0.0	0.0	-8.0	0.0	0.0	0.0
	MX	0.1	0.3	0.3	0.6	0.1	0.3	0.4	0.5
	QY	-0.2	-0.3	-0.3	-0.5	-0.1	-0.3	-0.2	-0.1
	MU	0.0	0.0	0.0	0.0	0.0	0.0	0.0	0.0
	QX	0.0	0.0	0.0	0.0	0.0	0.0	0.0	0.0
14	N	67.0	93.2	89.5	122.1	56.2	53.8	44.1	84.7
	MX	0.5	0.0	1.0	0.0	0.6	0.1	0.0	0.5
	QY	-0.4	0.0	-0.8	0.2	-0.2	-0.1	0.0	-1.4
	MU	0.8	1.2	0.0	0.0	0.0	-0.7	0.0	0.0
	QX	0.7	1.2	0.0	0.0	0.0	-0.3	0.0	0.0
ЯРУС 2 СЕЧЕНИЕ 2									
1	N	0.0	0.0	0.0	0.0	-2.8	-2.0	0.0	0.0
	MX	2.5	2.1	-3.0	-2.7	-0.4	1.2	0.0	2.0
	QY	1.3	1.5	-2.1	-2.3	-0.3	0.8	-0.7	1.7
	MU	2.7	-3.3	2.3	-3.0	-2.7	0.3	0.0	-1.5
	QX	1.3	2.1	-1.4	-2.3	-1.8	-0.2	0.2	0.8
8	N	0.0	0.0	0.0	0.0	0.0	6.9	0.0	0.0
	MX	0.0	0.0	0.0	0.0	0.0	0.0	0.0	0.0
	QY	0.0	0.0	0.0	0.0	0.0	0.0	0.0	0.0
	MU	-0.2	-0.3	-0.3	-0.4	-0.4	-0.1	0.0	-0.2
	QX	0.1	0.2	0.2	0.4	0.3	0.1	0.2	0.2
9	N	0.0	0.0	0.0	0.0	8.0	0.0	0.0	0.0
	MX	0.3	0.4	0.4	0.5	0.1	0.5	0.0	-0.4
	QY	0.2	0.3	0.3	0.5	0.1	0.3	0.2	0.0
	MU	0.0	0.0	0.0	0.0	0.0	0.0	0.0	0.0
	QX	0.0	0.0	0.0	0.0	0.0	0.0	0.0	0.0
14	N	-67.0	-93.2	-89.5	-122.1	-56.2	-53.8	-44.1	-84.7
	MX	-0.4	0.0	-1.3	-0.4	0.1	-0.2	0.0	-2.9
	QY	-0.4	0.0	-0.9	-0.2	-0.1	-0.1	0.0	-1.4
	MU	-0.9	-1.6	-0.1	-0.1	0.0	-0.1	0.0	0.0
	QX	-0.7	-1.2	0.0	0.0	0.0	0.3	0.0	0.0

ЛИСТ
2

1.220.1-3M.0-1.4 28МУ

ФОРМАТ А4

Номер загрузки	Тип усиления	Номер группы элементов							
		1	2	3	4	5	6	7	8
ЯРУС 3 СЕЧЕНИЕ 1									
1	N	0.0	0.0	0.0	0.0	1.7	1.6	0.0	0.0
	MX	-2.5	-2.1	3.0	2.7	0.1	-0.9	0.0	-2.0
	QY	0.9	0.8	-1.1	-1.0	-0.1	0.4	0.0	0.3
	MU	-2.7	3.3	-2.3	3.0	2.0	0.1	0.0	1.5
	QX	0.8	1.1	-0.7	-1.0	0.8	0.0	0.0	0.4
8	N	0.0	0.0	0.0	0.0	0.0	-4.3	0.0	0.0
	MX	0.0	0.0	0.0	0.0	0.0	0.0	0.0	0.0
	QY	0.0	0.0	0.0	0.0	0.0	0.0	0.0	0.0
	MU	0.2	0.3	0.3	0.4	0.3	-0.1	0.0	0.2
	QX	0.0	0.1	0.1	0.1	0.1	-0.1	0.0	0.0
9	N	0.0	0.0	0.0	0.0	-5.0	0.0	0.0	0.0
	MX	-0.3	-0.4	-0.4	-0.5	0.1	-0.3	0.0	0.4
	QY	0.1	0.2	0.2	0.2	-0.1	0.1	0.0	-0.5
	MU	0.0	0.0	0.0	0.0	0.0	0.0	0.0	0.0
	QX	0.0	0.0	0.0	0.0	0.0	0.0	0.0	0.0
14	N	44.3	60.9	58.5	78.0	22.8	18.9	0.0	53.6
	MX	0.4	0.0	-0.9	0.4	-0.4	0.2	0.0	1.0
	QY	-0.3	0.0	0.6	-0.6	0.3	-0.2	0.0	-1.2
	MU	1.0	1.5	0.1	0.1	0.1	-0.3	0.0	0.0
	QX	0.5	0.8	0.0	0.0	0.1	0.2	0.0	0.0
ЯРУС 3 СЕЧЕНИЕ 2									
1	N	0.0	0.0	0.0	0.0	-1.7	-1.6	0.0	0.0
	MX	0.5	0.4	0.6	0.6	0.1	-0.4	0.0	1.0
	QY	0.8	0.6	1.1	1.0	0.1	-0.4	0.0	-0.3
	MU	-0.4	-0.6	-0.4	0.5	0.7	0.1	0.0	0.2
	QX	-0.9	-1.1	0.4	1.0	-0.8	0.0	0.0	-0.4
8	N	0.0	0.0	0.0	0.0	0.0	4.3	0.0	0.0
	MX	0.0	0.0	0.0	0.0	0.0	0.0	0.0	0.0
	QY	0.0	0.0	0.0	0.0	0.0	0.0	0.0	0.0
	MU	-0.1	0.1	-0.1	0.1	0.1	-0.1	0.0	-0.1
	QX	0.0	-0.1	0.0	-0.1	-0.1	0.1	0.0	0.0
9	N	0.0	0.0	0.0	0.0	5.0	0.0	0.0	0.0
	MX	-0.1	-0.1	-0.1	-0.1	0.1	-0.1	0.0	1.2
	QY	-0.1	-0.1	-0.2	-0.2	0.1	-0.1	0.0	0.5
	MU	0.0	0.0	0.0	0.0	0.0	0.0	0.0	0.0
	QX	0.0	0.0	0.0	0.0	0.0	0.0	0.0	0.0
14	N	-44.3	-60.9	-58.5	-78.0	-22.8	-18.9	0.0	-53.6
	MX	-0.6	0.0	-1.2	-1.6	-0.6	-0.5	0.0	-3.0
	QY	-0.3	0.0	-0.6	-0.6	-0.3	-0.2	0.0	-1.2
	MU	0.7	1.1	0.1	0.1	0.1	-0.4	0.0	0.1
	QX	-0.5	-0.8	0.0	0.0	-0.1	-0.2	0.0	0.0

ЛИСТ
3

1.220.1-3M.0-1.4 28МУ

23171-04 137 ФОРМАТ А4

Классификация системы

Безуглова
ОПЕРАТОР СИСТЕМЫ
САПР
Классификация

ИНВ № ГОДЛ
ПОДПИСЬ И ДАТА
ВЗАМ. ИНВ №

Номер загрузки	Тип усилия	Номер группы элементов							
		1	2	3	4	5	6	7	8
ЯРУС 1 СЕЧЕНИЕ 1									
1	N	0.0	0.0	0.0	0.0	-17.3	-17.4	0.0	0.0
	MX	9.7	11.0	15.3	15.5	43.2	11.0	9.9	14.7
	QY	-2.8	-2.9	-4.1	-4.0	-33.3	-3.2	-2.6	-3.9
	MU	-10.6	-16.7	-12.5	-17.7	-26.0	-39.9	-7.5	-8.0
	QX	-2.6	-4.0	-2.6	-3.9	7.5	-21.7	-1.5	-1.4
8	N	0.0	0.0	0.0	0.0	0.0	-36.4	0.0	0.0
	MX	0.0	0.0	0.0	0.0	0.0	0.0	0.0	0.0
	QY	0.0	0.0	0.0	0.0	0.0	0.0	0.0	0.0
	MU	-0.4	-0.7	-0.7	-1.1	-1.6	-10.2	-0.7	-0.7
	QX	-0.1	-0.2	-0.2	-0.3	-0.4	-8.5	-0.2	-0.2
9	N	0.0	0.0	0.0	0.0	-42.4	0.0	0.0	0.0
	MX	0.5	0.8	0.8	1.2	11.9	1.8	0.8	1.0
	QY	-0.1	-0.2	-0.2	-0.3	-9.9	-0.4	-0.2	-0.3
	MU	0.0	0.0	0.0	0.0	0.0	0.0	0.0	0.0
	QX	0.0	0.0	0.0	0.0	0.0	0.0	0.0	0.0
14	N	117.1	159.4	153.3	204.5	153.9	148.7	126.5	148.5
	MX	-0.3	0.0	0.4	-0.2	7.0	0.0	0.0	-0.1
	QY	0.4	0.0	-0.9	0.1	-7.5	0.0	0.0	-0.7
	MU	0.6	0.7	0.0	0.0	0.0	-7.4	0.0	0.0
	QX	0.8	-1.3	0.0	0.0	0.0	-8.1	0.0	0.0
ЯРУС 1 СЕЧЕНИЕ 2									
1	N	0.0	0.0	0.0	0.0	17.3	17.4	0.0	0.0
	MX	-2.7	-3.6	-5.0	-5.5	40.2	-2.9	-3.3	-4.9
	QY	2.8	2.9	4.1	4.0	33.3	3.2	2.6	3.9
	MU	3.0	5.5	4.2	6.3	7.1	-37.6	2.5	2.7
	QX	2.6	4.0	2.6	3.9	-7.5	21.7	1.5	1.4
8	N	0.0	0.0	0.0	0.0	0.0	36.4	0.0	0.0
	MX	0.0	0.0	0.0	0.0	0.0	0.0	0.0	0.0
	QY	0.0	0.0	0.0	0.0	0.0	0.0	0.0	0.0
	MU	0.2	0.3	0.3	0.4	0.7	-11.0	0.3	0.3
	QX	0.1	0.2	0.2	0.3	0.4	8.5	0.2	0.2
9	N	0.0	0.0	0.0	0.0	42.4	0.0	0.0	0.0
	MX	-0.2	-0.3	-0.3	-0.5	12.9	-0.8	-0.3	-0.3
	QY	0.1	0.2	0.2	0.3	9.9	0.4	0.2	0.3
	MU	0.0	0.0	0.0	0.0	0.0	0.0	0.0	0.0
	QX	0.0	0.0	0.0	0.0	0.0	0.0	0.0	0.0
14	N	-117.1	-159.4	-153.3	-204.5	-153.9	-148.7	-126.5	-148.5
	MX	-0.8	0.0	-1.9	0.0	11.9	0.0	0.0	-1.9
	QY	-0.4	0.0	-0.9	0.1	7.5	0.0	0.0	-0.7
	MU	1.5	-2.6	0.0	0.0	0.0	-12.7	0.0	0.0
	QX	-0.8	-1.3	0.0	0.0	0.0	8.0	0.0	0.0

1.220.1-ЖМ.0-1.4 28МУ3			
ГИП	Егузов	СТАДИЯ	ЛИСТ
И КОНТР.	Бойко	Р	1
РУК. ГР.	Рудавин	ГОСГРАЖДАНСТРОИ	
ПРОВЕРИЛ	Футорная	КиевЗНИИЭП	
РАЗРАБ	Зуево	4Т 6.7.30-ЗАЛ(2*12)40-2.5	

ФОРМАТ А4

Номер загрузки	Тип усилия	Номер группы элементов							
		1	2	3	4	5	6	7	8
ЯРУС 2 СЕЧЕНИЕ 1									
1	N	0.0	0.0	0.0	0.0	-9.7	-11.1	0.0	0.0
	MX	2.7	3.6	5.0	5.5	-0.5	1.5	3.3	4.9
	QY	-2.8	-2.9	-4.1	-4.0	0.3	-1.4	-2.6	-3.9
	MU	-3.0	-5.5	-4.2	-6.3	-3.6	0.4	-2.5	-2.7
	QX	-2.6	-4.0	-2.6	-3.9	3.3	0.3	-1.5	-1.4
8	N	0.0	0.0	0.0	0.0	0.0	-14.9	0.0	0.0
	MX	0.0	0.0	0.0	0.0	0.0	0.0	0.0	0.0
	QY	0.0	0.0	0.0	0.0	0.0	0.0	0.0	0.0
	MU	-0.2	-0.3	-0.3	-0.4	-0.2	-0.5	-0.3	-0.3
	QX	-0.1	-0.2	-0.2	-0.3	-0.2	-0.3	-0.2	-0.2
9	N	0.0	0.0	0.0	0.0	17.4	0.0	0.0	0.0
	MX	0.2	0.3	0.3	0.5	0.6	0.2	0.3	0.3
	QY	-0.1	-0.2	-0.2	-0.3	-0.4	-0.2	-0.2	-0.3
	MU	0.0	0.0	0.0	0.0	0.0	0.0	0.0	0.0
	QX	0.0	0.0	0.0	0.0	0.0	0.0	0.0	0.0
14	N	89.6	125.4	120.6	166.2	64.8	63.0	88.2	115.8
	MX	0.6	0.0	1.1	0.0	0.7	0.0	0.0	1.1
	QY	-0.4	0.0	-0.9	-0.1	-0.3	0.0	0.0	-0.7
	MU	-1.0	1.5	0.0	0.0	0.0	0.7	0.0	0.0
	QX	0.8	1.3	0.0	0.0	0.0	0.4	0.0	0.0
ЯРУС 2 СЕЧЕНИЕ 2									
1	N	0.0	0.0	0.0	0.0	9.7	11.1	0.0	0.0
	MX	3.9	3.3	4.7	4.0	-0.3	1.8	3.0	4.5
	QY	2.8	2.9	4.1	4.0	-0.3	1.4	2.6	3.9
	MU	-4.2	-5.1	-3.7	-4.5	-4.2	0.3	-2.2	-2.4
	QX	2.6	4.0	2.6	3.9	-3.3	-0.3	1.5	1.4
8	N	0.0	0.0	0.0	0.0	0.0	14.9	0.0	0.0
	MX	0.0	0.0	0.0	0.0	0.0	0.0	0.0	0.0
	QY	0.0	0.0	0.0	0.0	0.0	0.0	0.0	0.0
	MU	-0.1	-0.1	-0.1	-0.2	-0.2	-0.3	-0.1	-0.1
	QX	0.1	0.2	0.2	0.3	0.2	0.3	0.2	0.2
9	N	0.0	0.0	0.0	0.0	-17.4	0.0	0.0	0.0
	MX	0.1	0.2	0.2	0.2	0.4	0.2	0.1	0.3
	QY	0.1	0.2	0.2	0.3	0.4	0.2	0.2	0.3
	MU	0.0	0.0	0.0	0.0	0.0	0.0	0.0	0.0
	QX	0.0	0.0	0.0	0.0	0.0	0.0	0.0	0.0
14	N	-89.6	-125.4	-120.6	-166.2	-64.8	-63.0	-88.2	-115.8
	MX	-0.5	0.0	1.1	-0.1	0.1	0.0	0.0	-0.6
	QY	-0.4	0.0	0.9	-0.1	0.3	0.0	0.0	-0.7
	MU	1.0	1.7	0.0	0.0	0.0	0.2	0.0	0.0
	QX	-0.8	-1.3	0.0	0.0	0.0	-0.4	0.0	0.0

ИНВ № ПОД	ПОДПИСЬ И ДАТА	ВЗАМ	ИНВ №
1.220.1-ЖМ.0-1.4 28МУ3			ЛИСТ 2

23171-04 138 ФОРМАТ А4

Номер загрузки	Тип усилия	Номер группы элементов							
		1	2	3	4	5	6	7	8
ЯРУС 3 СЕЧЕНИЕ 1									
1	N	0.0	0.0	0.0	0.0	-3.3	-3.4	0.0	0.0
	MX	-3.9	-3.3	-4.7	-4.0	0.1	-1.2	-3.0	-4.5
	QY	1.4	1.2	1.7	1.5	-0.1	0.5	0.9	1.6
	MU	4.2	5.1	3.7	4.5	2.8	0.1	2.2	2.4
	QX	1.3	1.7	1.1	1.4	1.2	0.1	0.5	0.6
8	N	0.0	0.0	0.0	0.0	0.0	-9.0	0.0	0.0
	MX	0.0	0.0	0.0	0.0	0.0	0.0	0.0	0.0
	QY	0.0	0.0	0.0	0.0	0.0	0.0	0.0	0.0
	MU	0.1	0.1	0.1	0.2	0.1	-0.2	0.1	0.1
	QX	0.0	0.1	0.1	0.1	0.0	-0.1	0.0	0.1
9	N	0.0	0.0	0.0	0.0	-10.4	0.0	0.0	0.0
	MX	-0.1	-0.2	-0.2	-0.2	0.3	-0.1	-0.1	-0.3
	QY	0.0	0.1	0.1	0.1	-0.2	0.0	0.0	0.3
	MU	0.0	0.0	0.0	0.0	0.0	0.0	0.0	0.0
	QX	0.0	0.0	0.0	0.0	0.0	0.0	0.0	0.0
14	N	67.0	93.2	89.5	122.1	29.0	27.0	44.1	84.7
	MX	0.3	0.0	0.9	0.1	0.4	0.1	0.0	1.3
	QY	-0.2	0.0	-0.6	-0.2	-0.3	-0.1	0.0	-1.3
	MU	-0.9	-1.4	0.0	0.0	0.0	0.3	0.0	0.0
	QX	3.5	0.9	0.0	0.0	0.0	0.2	0.0	0.0
ЯРУС 3 СЕЧЕНИЕ 2									
1	N	0.0	0.0	0.0	0.0	3.3	3.4	0.0	0.0
	MX	-0.8	-0.7	1.0	0.9	0.1	-0.5	0.0	-0.7
	QY	-1.2	-1.2	1.7	1.5	0.1	-0.5	-0.8	-1.6
	MU	-0.8	1.0	-0.6	0.9	1.0	0.1	0.0	0.4
	QX	1.5	-1.7	0.6	1.4	-1.2	-0.1	0.3	-0.6
8	N	0.0	0.0	0.0	0.0	0.0	9.0	0.0	0.0
	MX	0.0	0.0	0.0	0.0	0.0	0.0	0.0	0.0
	QY	0.0	0.0	0.0	0.0	0.0	0.0	0.0	0.0
	MU	0.1	0.0	0.1	0.1	0.0	-0.2	0.0	0.1
	QX	0.0	-0.1	-0.1	-0.1	0.0	0.1	0.0	-0.1
9	N	0.0	0.0	0.0	0.0	10.4	0.0	0.0	0.0
	MX	0.0	-0.1	0.0	-0.1	0.2	0.0	0.0	-0.7
	QY	0.0	-0.1	-0.1	-0.1	0.2	0.0	0.0	-0.3
	MU	0.0	0.0	0.0	0.0	0.0	0.0	0.0	0.0
	QX	0.0	0.0	0.0	0.0	0.0	0.0	0.0	0.0
14	N	-67.0	-93.2	-89.5	-122.1	-29.0	-27.0	-44.1	-84.7
	MX	0.4	0.0	-1.2	-0.5	-0.5	-0.2	0.0	-2.9
	QY	0.2	0.0	-0.6	-0.2	-0.3	-0.1	0.0	-1.3
	MU	-1.0	-1.6	-0.1	-0.1	0.0	0.4	0.0	0.0
	QX	0.5	0.9	0.0	0.0	0.0	-0.2	0.0	0.0

ЛИСТ
3

1.220.1-3М.0-1.4 28МУ3

Номер загрузки	Тип усилия	Номер группы элементов							
		1	2	3	4	5	6	7	8
ЯРУС 4 СЕЧЕНИЕ 1									
1	N	0.0	0.0	0.0	0.0	-0.8	-0.9	0.0	0.0
	MX	0.8	0.7	-1.0	-0.9	0.0	0.0	0.0	0.7
	QY	-0.3	-0.2	0.4	0.3	0.0	0.0	0.0	-0.1
	MU	0.8	-1.0	0.6	-0.9	-0.2	-0.1	0.0	-0.4
	QX	0.2	-0.4	0.1	0.3	0.1	0.0	0.0	-0.1
8	N	0.0	0.0	0.0	0.0	0.0	-4.4	-0.1	0.0
	MX	0.0	0.0	0.0	0.0	0.0	0.0	-0.1	0.0
	QY	0.0	0.0	0.0	0.0	0.0	0.0	-0.1	0.0
	MU	-0.1	0.0	-0.1	-0.1	0.0	-0.2	-0.1	-0.1
	QX	0.0	0.0	0.0	0.0	0.0	-0.1	-0.1	0.0
9	N	0.0	0.0	0.0	0.0	5.2	0.0	0.0	0.0
	MX	0.0	0.1	0.0	0.1	0.2	-0.1	0.0	0.7
	QY	0.0	0.0	0.0	0.0	-0.1	0.1	0.0	-0.5
	MU	0.0	0.0	0.0	0.0	0.0	0.0	0.0	0.0
	QX	0.0	0.0	0.0	0.0	0.0	0.0	0.0	0.0
14	N	44.3	60.9	58.5	78.0	15.9	12.0	-0.4	53.7
	MX	3.4	0.0	-1.1	0.5	-0.8	0.2	-0.4	1.0
	QY	-0.3	0.0	0.7	-0.6	0.5	-0.2	-0.4	-1.2
	MU	0.9	1.5	0.1	0.1	0.1	-0.6	-0.4	0.0
	QX	0.5	-0.8	0.0	0.0	0.1	0.4	-0.4	0.0
ЯРУС 4 СЕЧЕНИЕ 2									
1	N	0.0	0.0	0.0	0.0	0.8	0.9	0.0	0.0
	MX	-0.2	-0.1	0.2	0.2	0.0	0.0	0.0	-0.3
	QY	-0.3	-0.2	0.4	0.3	0.0	0.0	0.0	0.1
	MU	0.1	-0.2	0.1	0.2	-0.1	0.0	0.0	0.0
	QX	0.2	0.3	-0.1	-0.2	-0.1	0.0	0.0	0.1
8	N	0.0	0.0	0.0	0.0	0.0	4.4	0.1	0.0
	MX	0.0	0.0	0.0	0.0	0.0	0.0	0.1	0.0
	QY	0.0	0.0	0.0	0.0	0.0	0.0	0.1	0.0
	MU	0.0	0.0	0.0	0.0	0.0	-0.1	0.1	0.0
	QX	0.0	0.0	0.0	0.0	0.0	0.1	0.1	0.0
9	N	0.0	0.0	0.0	0.0	-5.2	0.0	0.0	0.0
	MX	0.0	0.0	-0.1	-0.1	0.1	-0.1	0.0	1.0
	QY	0.0	0.0	0.0	0.0	0.1	-0.1	0.0	0.5
	MU	0.0	0.0	0.0	0.0	0.0	0.0	0.0	0.0
	QX	0.0	0.0	0.0	0.0	0.0	0.0	0.0	0.0
14	N	-44.3	-60.9	-58.5	-78.0	-15.9	-12.0	0.4	-53.7
	MX	-0.6	0.0	-1.2	-1.7	-0.9	-0.5	0.4	-2.8
	QY	-0.3	0.0	-0.7	-0.6	-0.5	-0.2	0.4	-1.2
	MU	0.7	1.1	0.1	0.1	0.1	-0.6	0.4	0.1
	QX	-0.5	-0.8	0.0	0.0	-0.1	0.4	0.4	0.0

ЛИСТ
4

1.220.1-3М.0-1.4 28МУ3

Безуглова
ОПЕРАТОР СИСТЕМ
САПР КиевЗНИИЭП

ИНВ № ПОДЛ
ПОДПИСЬ И ДАТА
ВЗАМ. ИНВ №

Номер загрузки	Тип усилия	Номер группы элементов							
		1	2	3	4	5	6	7	8
ЯРУС 1 СЕЧЕНИЕ 1									
1	N	0.0	0.0	0.0	0.0	-21.4	-20.2	0.0	0.0
	MX	6.1	7.3	10.3	11.9	22.4	7.3	6.8	10.1
	QY	-1.3	-1.5	-2.1	-2.3	-11.1	-1.7	-1.4	-2.0
	MU	-6.8	-11.6	-8.6	-14.0	-17.7	-18.5	-5.2	-5.5
	QX	-1.3	-2.2	-1.4	-2.4	4.1	-7.0	-0.8	-0.8
8	N	0.0	0.0	0.0	0.0	0.0	-39.0	0.0	0.0
	MX	0.0	0.0	0.0	0.0	0.0	0.0	0.0	0.0
	QY	0.0	0.0	0.0	0.0	0.0	0.0	0.0	0.0
	MU	-0.9	-1.6	-1.6	-2.7	-3.5	-14.4	-1.6	-1.6
	QX	-0.2	-0.3	-0.3	-0.5	-0.7	-7.2	-0.3	-0.3
9	N	0.0	0.0	0.0	0.0	-45.4	0.0	0.0	0.0
	MX	1.1	1.9	1.9	3.2	16.8	3.9	1.8	2.0
	QY	-0.2	-0.4	-0.4	-0.6	-8.4	-0.8	-0.4	-0.4
	MU	0.0	0.0	-0.1	0.0	0.0	0.0	0.0	-0.1
	QX	0.0	0.0	0.0	0.0	0.0	0.0	0.0	0.0
14	N	117.1	159.4	153.3	204.5	173.3	169.7	126.5	148.5
	MX	-0.5	0.0	-1.2	-0.2	5.4	0.0	0.0	-0.8
	QY	0.4	0.0	0.9	0.0	-3.8	0.0	0.0	0.7
	MU	1.0	1.7	0.0	0.0	0.0	-5.6	0.0	0.0
	QX	0.7	1.1	0.6	0.0	0.0	-3.9	0.0	0.0
ЯРУС 1 СЕЧЕНИЕ 2									
1	N	0.0	0.0	0.0	0.0	21.4	20.2	0.0	0.0
	MX	-0.7	-1.4	-2.0	-2.8	22.0	0.5	-1.3	-1.9
	QY	1.3	1.5	2.1	2.3	11.1	-1.7	1.4	2.0
	MU	0.3	2.2	1.7	3.3	1.3	-18.5	1.0	1.1
	QX	1.3	2.2	1.4	2.4	-4.1	-6.8	0.8	0.3
8	N	0.0	0.0	0.0	0.0	0.0	39.0	0.0	0.0
	MX	0.0	0.0	0.0	0.0	0.0	0.0	0.0	0.0
	QY	0.0	0.0	0.0	0.0	0.0	0.0	0.0	0.0
	MU	0.2	0.4	0.4	0.7	0.5	-14.5	0.4	0.4
	QX	0.2	0.3	0.3	0.5	0.7	1.2	0.3	0.3
9	N	0.0	0.0	0.0	0.0	45.4	0.0	0.0	0.0
	MX	-0.2	-0.4	-0.4	-0.8	16.9	-0.7	-0.4	-0.4
	QY	0.2	0.4	0.3	0.6	8.4	0.8	0.4	0.4
	MU	0.0	0.0	0.0	0.0	0.0	0.0	0.0	0.0
	QX	0.0	0.0	0.0	0.0	0.0	0.0	0.0	0.0
14	N	-117.1	-159.4	-153.3	-204.5	-173.3	-169.7	-126.5	-148.5
	MX	-0.9	0.0	-2.3	0.0	9.7	0.0	0.0	-2.1
	QY	-0.4	0.0	-0.9	0.0	3.8	0.0	0.0	-0.7
	MU	1.7	2.9	0.0	0.0	0.0	-10.2	0.0	0.0
	QX	-0.7	-1.1	0.0	0.0	0.0	3.9	0.0	0.0

1.220.1-3М.0-1.4 28МУ4

ГИП	Егунов		СТАДИЯ	ЛИСТ	ЛИСТОВ
И.КОНТР	Бойко		Р	4	4
РУКЛР.	Рудан		ГОСГРАЖДАНСТРОЙ		
ПРОВЕРИЛ	Футорман		КиевЗНИИЭП		
РАЗРАБ	Зуевко		ЗДАНИЕ		
			ИТ 6.7.30-ЗАЛ(2*12)40-4.0		

Номер загрузки	Тип усилия	Номер группы элементов							
		1	2	3	4	5	6	7	8
ЯРУС 2 СЕЧЕНИЕ 1									
1	N	0.0	0.0	0.0	0.0	2.9	1.8	0.0	0.0
	MX	0.7	1.4	2.0	2.8	-0.4	0.7	1.3	1.9
	QY	-1.3	-1.5	-2.1	-2.3	0.3	-0.8	-1.4	-2.0
	MU	-0.8	-2.2	-1.7	-3.3	-1.7	0.3	-1.0	-1.1
	QX	-1.3	-2.2	-1.4	-2.4	1.9	0.2	-0.8	-0.8
8	N	0.0	0.0	0.0	0.0	0.0	13.9	0.0	0.0
	MX	0.0	0.0	0.0	0.0	0.0	0.0	0.0	0.0
	QY	0.0	0.0	0.0	0.0	0.0	0.0	0.0	0.0
	MU	-0.2	-0.4	-0.4	-0.7	-0.3	-0.3	-0.4	-0.4
	QX	-0.2	-0.3	-0.3	-0.5	-0.3	-0.2	-0.3	-0.3
9	N	0.0	0.0	0.0	0.0	-16.1	0.0	0.0	0.0
	MX	0.2	0.4	0.4	0.8	0.4	0.4	0.4	0.4
	QY	-0.2	-0.4	-0.3	-0.5	-0.3	-0.4	-0.4	-0.4
	MU	0.0	0.0	0.0	0.0	0.0	0.0	0.0	0.0
	QX	0.0	0.0	0.0	0.0	0.0	0.0	0.0	0.0
14	N	89.6	125.4	120.6	166.2	73.3	71.4	88.2	115.8
	MX	0.5	0.0	1.0	0.0	1.1	0.0	0.0	1.1
	QY	-0.4	0.0	-0.8	0.0	-0.6	0.0	0.0	-0.7
	MU	-0.8	-1.2	0.0	0.0	0.0	1.1	0.0	0.0
	QX	0.7	1.1	0.0	0.0	0.0	0.6	0.0	0.0
ЯРУС 2 СЕЧЕНИЕ 2									
1	N	0.0	0.0	0.0	0.0	-2.9	-1.8	0.0	0.0
	MX	2.5	2.1	3.0	2.7	-0.4	1.2	1.9	2.9
	QY	1.3	1.5	2.1	2.3	-0.3	0.8	1.4	2.0
	MU	-2.8	-3.4	-2.5	-3.1	-2.8	0.2	-1.4	-1.6
	QX	1.3	2.2	1.4	2.4	-1.9	-0.2	0.8	0.8
8	N	0.0	0.0	0.0	0.0	0.0	-13.9	0.0	0.0
	MX	0.0	0.0	0.0	0.0	0.0	0.0	0.0	0.0
	QY	0.0	0.0	0.0	0.0	0.0	0.0	0.0	0.0
	MU	-0.3	-0.4	-0.4	-0.5	-0.5	-0.2	-0.4	-0.4
	QX	0.2	0.3	0.3	0.5	0.3	0.2	0.3	0.3
9	N	0.0	0.0	0.0	0.0	16.1	0.0	0.0	0.0
	MX	0.4	0.5	0.5	0.6	0.5	0.5	0.4	0.6
	QY	0.2	0.4	0.4	0.6	0.3	0.4	0.4	0.4
	MU	0.0	0.0	0.0	0.0	0.0	0.0	0.0	0.0
	QX	0.0	0.0	0.0	0.0	0.0	0.0	0.0	0.0
14	N	-89.6	-125.4	-120.6	-166.2	-73.3	-71.4	-88.2	-115.8
	MX	-0.4	0.0	-1.1	-0.1	0.3	0.0	0.0	-0.6
	QY	-0.4	0.0	-0.9	0.0	0.6	0.0	0.0	-0.7
	MU	0.9	1.5	0.0	0.0	0.0	0.4	0.0	0.0
	QX	-0.7	-1.1	0.0	0.0	0.0	0.6	0.0	0.0

1.220.1-3М.0-1.4 28МУ4

ЛИСТ	2
------	---

КиевЗНИИЭП

Безупоко
ОПЕРАТОР СИСТЕМЫ
САПР
КиевЗНИИЭП

ИНВ № ПОДП
ПОДПИСЬ И ДАТА
ВЗАМ ИНВЕНТ

Номер загрузки	Тип усилия	Номер группы элементов							
		1	2	3	4	5	6	7	8
ЯРУС 3 СЕЧЕНИЕ 1									
1	N	0.0	0.0	0.0	0.0	1.8	1.5	0.0	0.0
	MX	-2.5	-2.1	-3.0	-2.7	-0.1	-0.9	-1.9	-2.9
	MY	0.9	0.8	1.1	1.0	0.1	0.4	0.6	1.0
	MZ	2.8	3.4	2.5	3.1	2.1	0.1	1.4	1.6
	QX	0.9	1.2	0.8	1.0	-0.8	0.0	0.4	0.4
8	N	0.0	0.0	0.0	0.0	0.0	-8.9	0.0	0.0
	MX	0.0	0.0	0.0	0.0	0.0	0.0	0.0	0.0
	MY	0.0	0.0	0.0	0.0	0.0	0.0	0.0	0.0
	MZ	0.3	0.4	0.4	0.5	0.3	-0.2	0.4	0.4
	QX	0.1	0.1	0.1	0.2	0.1	-0.1	0.1	0.1
9	N	0.0	0.0	0.0	0.0	-10.4	0.0	0.0	0.0
	MX	-0.4	-0.5	-0.5	-0.6	0.3	-0.3	-0.4	-0.6
	MY	0.1	0.2	0.2	0.2	-0.1	0.1	0.1	0.4
	MZ	0.0	0.0	0.0	0.0	0.0	0.0	0.0	0.0
	QX	0.0	0.0	0.0	0.0	0.0	0.0	0.0	0.0
14	N	67.0	93.2	89.5	122.1	31.4	29.3	44.1	84.7
	MX	0.4	0.0	1.0	0.1	0.3	0.1	0.0	1.3
	MY	-0.2	0.0	-0.7	-0.2	-0.2	-0.1	0.0	-1.3
	MZ	-1.0	-1.6	0.0	0.0	0.0	0.2	0.0	0.0
	QX	0.6	1.0	0.0	0.0	0.0	0.2	0.0	0.0
ЯРУС 3 СЕЧЕНИЕ 2									
1	N	0.0	0.0	0.0	0.0	-1.8	-1.5	0.0	0.0
	MX	-0.5	-0.4	0.7	0.6	-0.1	-0.3	0.0	-0.5
	MY	-0.8	-0.8	1.1	1.0	-0.1	-0.4	-0.5	-1.0
	MZ	-0.5	0.7	0.4	0.6	0.7	0.1	0.0	0.2
	QX	1.0	-1.2	0.4	1.0	0.8	0.0	0.2	-0.4
8	N	0.0	0.0	0.0	0.0	0.0	8.9	0.0	0.0
	MX	0.0	0.0	0.0	0.0	0.0	0.0	0.0	0.0
	MY	0.0	0.0	0.0	0.0	0.0	0.0	0.0	0.0
	MZ	0.1	0.1	0.1	0.1	0.1	-0.2	0.0	0.1
	QX	-0.1	-0.1	-0.1	-0.2	-0.1	0.1	-0.1	-0.1
9	N	0.0	0.0	0.0	0.0	10.4	0.0	0.0	0.0
	MX	-0.1	-0.1	-0.1	-0.1	0.2	-0.1	0.0	-0.8
	MY	-0.1	-0.2	-0.2	-0.2	0.1	-0.1	-0.1	-0.4
	MZ	0.0	0.0	0.0	0.0	0.0	0.0	0.0	0.0
	QX	0.0	0.0	0.0	0.0	0.0	0.0	0.0	0.0
14	N	-67.0	-93.2	-89.5	-122.1	-31.4	-29.3	-44.1	-84.7
	MX	0.4	0.0	-1.2	-0.5	-0.5	-0.2	0.0	-2.9
	MY	0.2	0.0	-0.7	-0.2	-0.2	-0.1	0.0	-1.3
	MZ	-1.0	-1.6	-0.1	-0.1	0.0	0.4	0.0	0.0
	QX	0.6	1.0	0.0	0.0	0.0	-0.2	0.0	0.0

1.220.1-3М.0-1.4 28МУ4

ЛИСТ
3

ФОРМАТ А4

Номер загрузки	Тип усилия	Номер группы элементов							
		1	2	3	4	5	6	7	8
ЯРУС 4 СЕЧЕНИЕ 1									
1	N	0.0	0.0	0.0	0.0	0.3	0.2	0.0	0.0
	MX	-0.5	0.4	-0.7	-0.6	0.0	0.0	0.0	0.5
	MY	-0.2	-0.2	0.2	0.2	0.0	0.0	0.0	-0.1
	MZ	0.5	-0.7	-0.4	-0.6	0.0	0.0	0.0	-0.2
	QX	0.2	-0.2	0.1	0.2	0.0	0.0	0.0	-0.1
8	N	0.0	0.0	0.0	0.0	0.0	-4.4	0.0	0.0
	MX	0.0	0.0	0.0	0.0	0.0	0.0	0.0	0.0
	MY	0.0	0.0	0.0	0.0	0.0	0.0	0.0	0.0
	MZ	-0.1	-0.1	-0.1	-0.1	0.0	-0.2	0.0	-0.1
	QX	0.0	0.0	0.0	0.0	0.0	-0.1	0.0	0.0
9	N	0.0	0.0	0.0	0.0	5.1	0.0	0.0	0.0
	MX	0.1	0.1	0.1	0.1	0.2	-0.1	0.0	0.8
	MY	0.0	0.0	0.0	0.0	-0.1	0.1	0.0	-0.5
	MZ	0.0	0.0	0.0	0.0	0.0	0.0	0.0	0.0
	QX	0.0	0.0	0.0	0.0	0.0	0.0	0.0	0.0
14	N	44.3	60.9	58.5	78.0	16.3	12.4	0.0	53.7
	MX	0.4	0.0	-1.0	0.5	-0.7	0.2	0.0	1.0
	MY	-0.3	0.0	0.7	-0.6	0.5	-0.2	0.0	-1.2
	MZ	0.9	1.5	0.1	0.1	0.1	-0.6	0.0	0.0
	QX	0.5	-0.7	0.0	0.0	0.1	0.4	0.0	0.0
ЯРУС 4 СЕЧЕНИЕ 2									
1	N	-0.0	0.0	0.0	0.0	-0.3	-0.2	0.0	0.0
	MX	-0.1	-0.1	0.1	0.1	0.0	0.0	0.0	-0.2
	MY	-0.2	-0.2	0.3	0.2	0.0	0.0	0.0	0.1
	MZ	0.1	-0.1	0.1	-0.1	0.0	0.0	0.0	0.0
	QX	0.2	0.2	-0.1	-0.1	0.0	0.0	0.0	0.0
8	N	0.0	0.0	0.0	0.0	0.0	4.4	0.0	0.0
	MX	0.0	0.0	0.0	0.0	0.0	0.0	0.0	0.0
	MY	0.0	0.0	0.0	0.0	0.0	0.0	0.0	0.0
	MZ	0.0	0.0	0.0	0.0	0.0	-0.1	0.0	0.0
	QX	0.0	0.0	0.0	0.0	0.0	0.1	0.0	0.0
9	N	0.0	0.0	0.0	0.0	-5.1	0.0	0.0	0.0
	MX	0.0	0.0	0.0	0.0	0.1	-0.1	0.0	1.0
	MY	0.0	0.0	0.0	0.0	0.1	-0.1	0.0	0.5
	MZ	0.0	0.0	0.0	0.0	0.0	0.0	0.0	0.0
	QX	0.0	0.0	0.0	0.0	0.0	0.0	0.0	0.0
14	N	-44.3	-60.9	-58.5	-78.0	-16.3	-12.4	0.0	-53.7
	MX	-0.5	0.0	-1.2	-1.7	-0.8	-0.5	0.0	-2.8
	MY	-0.3	0.0	-0.7	-0.6	-0.5	-0.2	0.0	-1.2
	MZ	0.7	1.1	0.1	0.1	0.1	-0.6	0.0	0.1
	QX	-0.5	-0.7	0.0	0.0	-0.1	0.4	0.0	0.0

1.220.1-3М.0-1.4 28МУ4

ЛИСТ
4

23171-04 141 ФОРМАТ А4

Номер загрузки	Тип усилia	Номер группы элементов							
		1	2	3	4	5	6	7	8
ЯРУС 1 СЕЧЕНИЕ 1									
1	N	0.0	0.0	0.0	0.0	-15.4	-14.6	0.0	0.0
	MX	3.4	5.7	8.1	6.9	12.3	4.3	5.3	7.8
	QU	-1.0	-1.3	-1.9	-1.6	-7.0	-1.3	-1.2	-1.8
	MU	-3.8	-9.1	-6.7	-8.2	-10.3	-9.6	-4.0	-4.3
	QX	-1.0	-1.9	-1.3	-1.6	3.2	-4.1	-0.8	-0.7
8	N	0.0	0.0	0.0	0.0	0.0	-37.4	0.0	0.0
	MX	0.0	0.0	0.0	0.0	0.0	0.0	0.0	0.0
	QU	0.0	0.0	0.0	0.0	0.0	0.0	0.0	0.0
	MU	-0.7	-1.8	-1.8	-2.3	-2.8	-11.1	-1.8	-1.8
	QX	-0.2	-0.4	-0.4	-0.5	-0.8	-6.4	-0.4	-0.4
9	N	0.0	0.0	0.0	0.0	-43.5	0.0	0.0	0.0
	MX	0.9	2.1	2.1	2.7	13.0	3.2	2.0	2.2
	QU	-0.2	-0.5	-0.5	-0.6	-7.5	-0.9	-0.5	-0.5
	MU	0.0	0.0	-0.1	0.0	0.0	0.0	0.0	-0.1
	QX	0.0	0.0	0.0	0.0	0.0	0.0	0.0	0.0
14	N	117.1	159.4	153.3	204.5	168.3	164.6	126.5	148.5
	MX	-0.5	0.0	1.1	-0.1	3.0	0.0	0.0	0.8
	QU	0.4	0.0	-0.9	0.0	-2.4	0.0	0.0	-0.8
	MU	1.0	1.6	0.0	0.0	0.0	-3.2	0.0	0.0
	QX	0.7	-1.2	0.0	0.0	0.0	-2.5	0.0	0.0
ЯРУС 1 СЕЧЕНИЕ 2									
1	N	0.0	0.0	0.0	0.0	15.4	14.6	0.0	0.0
	MX	0.0	-1.1	-1.5	-1.5	12.2	0.3	-1.0	-1.4
	QU	0.8	1.3	1.9	1.6	7.0	1.3	1.2	1.8
	MU	0.0	1.7	1.3	1.8	-0.7	-9.6	0.8	0.8
	QX	-1.1	1.9	1.3	1.6	-3.2	4.1	0.8	0.7
8	N	0.0	0.0	0.0	0.0	0.0	37.4	0.0	0.0
	MX	0.0	0.0	0.0	0.0	0.0	0.0	0.0	0.0
	QU	0.0	0.0	0.0	0.0	0.0	0.0	0.0	0.0
	MU	0.1	0.4	0.4	0.5	0.1	-11.3	0.4	0.4
	QX	0.2	0.4	0.4	0.5	0.8	6.4	0.4	0.4
9	N	0.0	0.0	0.0	0.0	43.5	0.0	0.0	0.0
	MX	-0.1	-0.5	-0.5	-0.6	13.1	-0.1	-0.5	-0.4
	QU	0.2	0.5	0.4	0.6	7.5	0.9	0.4	0.5
	MU	0.0	0.0	0.0	0.0	0.0	0.0	0.0	0.0
	QX	0.0	0.0	0.0	0.0	0.0	0.0	0.0	0.0
14	N	-117.1	-159.4	-153.3	-204.5	-168.3	-164.6	-126.5	-148.5
	MX	-0.8	0.0	-2.1	0.0	5.2	0.0	0.0	-2.0
	QU	-0.4	0.0	-0.9	0.0	2.4	0.0	0.0	-0.8
	MU	1.5	2.7	0.0	0.0	0.0	-3.5	0.0	0.0
	QX	-0.7	-1.2	0.0	0.0	0.0	2.4	0.0	0.0

1.220.1-3M.0-1.4 28МУ5

ГИП	Егузов		СТАДИЯ	ЛИСТ	ЛИСТОВ
И.КОНТР.	Бойко		Р	1	4
РУКЛР.	Рудавин		ЗДАНИЕ ГОСГРАЖДАНСТРОЙ КиевЗНИИЭП		
ПРОВЕРИЛ	Футормя				
РАЗРАБ	Зуевко				
		4Т6.7.30-ЗАЛ(2*12)*32-3.5			

ФОРМАТ А4

Номер загрузки	Тип усилia	Номер группы элементов							
		1	2	3	4	5	6	7	8
ЯРУС 2 СЕЧЕНИЕ 1									
1	N	0.0	0.0	0.0	0.0	2.2	1.5	0.0	0.0
	MX	0.0	1.1	1.5	1.5	-0.3	0.5	1.0	1.4
	QU	-0.8	-1.3	-1.9	-1.6	0.2	-0.6	-1.2	-1.8
	MU	0.0	-1.7	-1.3	-1.8	-1.1	0.2	-0.8	-0.8
	QX	1.1	-1.9	-1.3	-1.6	1.5	0.2	-0.8	-0.7
8	N	0.0	0.0	0.0	0.0	0.0	15.5	0.0	0.0
	MX	0.0	0.0	0.0	0.0	0.0	0.0	0.0	0.0
	QU	0.0	0.0	0.0	0.0	0.0	0.0	0.0	0.0
	MU	-0.1	-0.4	-0.4	-0.5	-0.3	-0.5	-0.4	-0.4
	QX	-0.2	-0.4	-0.4	-0.5	-0.4	-0.3	-0.4	-0.4
9	N	0.0	0.0	0.0	0.0	18.1	0.0	0.0	0.0
	MX	-0.1	0.5	0.5	0.6	0.6	0.3	0.5	0.4
	QU	-0.2	-0.5	-0.4	-0.6	-0.4	-0.4	-0.4	-0.5
	MU	0.0	0.0	0.0	0.0	0.0	0.0	0.0	0.0
	QX	0.0	0.0	0.0	0.0	0.0	0.0	0.0	0.0
14	N	89.6	125.4	120.6	166.2	75.6	74.0	88.2	115.8
	MX	0.6	0.0	1.2	0.0	1.1	0.0	0.0	1.3
	QU	-0.4	0.0	-0.9	0.0	-0.6	0.0	0.0	-0.8
	MU	-0.9	-1.4	0.0	0.0	0.0	1.1	0.0	0.0
	QX	0.7	1.2	0.0	0.0	0.0	-0.6	0.0	0.0
ЯРУС 2 СЕЧЕНИЕ 2									
1	N	0.0	0.0	0.0	0.0	-2.2	-1.5	0.0	0.0
	MX	2.3	2.1	3.0	2.2	-0.3	1.0	1.9	2.9
	QU	1.0	1.3	1.9	1.6	-0.2	0.6	1.2	1.8
	MU	-2.6	-3.3	-2.4	-2.6	-2.5	0.2	-1.4	-1.5
	QX	1.0	1.9	1.3	1.6	-1.5	-0.2	0.8	0.7
8	N	0.0	0.0	0.0	0.0	0.0	-15.5	0.0	0.0
	MX	0.0	0.0	0.0	0.0	0.0	0.0	0.0	0.0
	QU	0.0	0.0	0.0	0.0	0.0	0.0	0.0	0.0
	MU	-0.4	-0.6	-0.5	-0.6	-0.6	-0.3	-0.5	-0.5
	QX	0.2	0.4	0.4	0.5	0.4	0.3	0.4	0.4
9	N	0.0	0.0	0.0	0.0	-18.1	0.0	0.0	0.0
	MX	0.5	0.7	0.7	0.8	0.4	0.6	0.6	0.8
	QU	0.2	0.5	0.5	0.6	0.4	0.4	0.5	0.5
	MU	0.0	0.0	0.0	0.0	0.0	0.0	0.0	0.0
	QX	0.0	0.0	0.0	0.0	0.0	0.0	0.0	0.0
14	N	-89.6	-125.4	-120.6	-166.2	-75.6	-74.0	-88.2	-115.8
	MX	-0.4	0.0	-1.1	-0.1	0.3	0.0	0.0	-0.6
	QU	-0.4	0.0	-0.9	0.0	0.6	0.0	0.0	-0.8
	MU	-0.8	1.5	0.0	0.0	0.0	0.4	0.0	0.0
	QX	-0.7	-1.2	0.0	0.0	0.0	0.6	0.0	0.0

Безупоко
Beys
САПР
КиевЗНИИЭП
ПОДПИСЬ И ДАТА
ИНВ № ПОДЛ

1.220.1-3M.0-1.4 28МУ5

ЛИСТ
2

23171-04 142 ФОРМАТ А4

загрузка		усилия							
		1	2	3	4	5	6	7	8
ЯРУС 3 СЕЧЕНИЕ 1									
1	N	0.0	0.0	0.0	0.0	1.4	1.1	0.0	0.0
	MX	-2.3	-2.1	-3.0	-2.2	-0.1	-0.9	-1.9	-2.9
	QY	0.9	0.8	1.1	0.8	0.0	0.4	0.6	1.0
	MU	2.6	3.3	2.4	2.6	2.0	0.1	1.4	1.5
	QX	0.9	1.2	0.8	0.9	-0.8	0.0	0.4	0.4
8	N	0.0	0.0	0.0	0.0	0.0	-9.4	0.0	0.0
	MX	0.0	0.0	0.0	0.0	0.0	0.0	0.0	0.0
	QY	0.0	0.0	0.0	0.0	0.0	0.0	0.0	0.0
	MU	0.4	0.6	0.5	0.6	0.5	-0.3	0.5	0.5
	QX	0.1	0.2	0.2	0.2	0.2	-0.1	0.2	0.2
9	N	0.0	0.0	0.0	0.0	-10.9	0.0	0.0	0.0
	MX	-0.5	-0.7	-0.7	-0.8	0.3	-0.5	-0.6	-0.8
	QY	0.2	0.3	0.2	0.3	-0.2	0.2	0.2	0.5
	MU	0.0	0.0	0.0	0.0	0.0	0.0	0.0	0.0
	QX	0.0	0.0	0.0	0.0	0.0	0.0	0.0	0.0
14	N	67.0	93.2	89.5	122.1	32.3	30.4	44.1	84.7
	MX	0.4	0.0	0.9	0.1	0.2	0.1	0.0	1.3
	QY	-0.2	0.0	-0.7	-0.2	-0.2	-0.1	0.0	-1.3
	MU	-1.1	-1.5	0.0	0.0	0.0	0.1	0.0	0.0
	QX	0.6	1.0	0.0	0.0	0.0	0.1	0.0	0.0
ЯРУС 3 СЕЧЕНИЕ 2									
1	N	0.0	0.0	0.0	0.0	-1.4	-1.1	0.0	0.0
	MX	-0.5	-0.4	0.7	0.5	-0.1	-0.3	0.0	-0.5
	QY	-0.8	-0.8	1.1	0.8	0.0	-0.4	-0.5	-1.0
	MU	-0.5	0.7	-0.4	0.5	0.7	0.1	0.0	0.3
	QX	0.9	-1.2	0.4	0.9	0.8	0.0	0.2	-0.4
8	N	0.0	0.0	0.0	0.0	0.0	9.4	0.0	0.0
	MX	0.0	0.0	0.0	0.0	0.0	0.0	0.0	0.0
	QY	0.0	0.0	0.0	0.0	0.0	0.0	0.0	0.0
	MU	0.1	0.1	0.1	0.2	0.2	-0.2	0.0	0.1
	QX	-0.1	-0.2	-0.2	-0.2	-0.2	0.1	-0.2	-0.2
9	N	0.0	0.0	0.0	0.0	10.9	0.0	0.0	0.0
	MX	-0.1	-0.2	-0.1	-0.2	0.2	-0.1	0.0	-0.8
	QY	-0.2	-0.3	-0.2	-0.3	0.2	-0.2	-0.2	-0.5
	MU	0.0	0.0	0.1	0.0	0.0	0.0	0.0	0.1
	QX	0.0	0.0	0.0	0.0	0.0	0.0	0.0	0.0
14	N	-67.0	-93.2	-89.5	-122.1	-32.3	-30.4	-44.1	-84.7
	MX	0.4	0.0	-1.2	-0.5	-0.4	-0.2	0.0	-2.9
	QY	0.2	0.0	-0.6	-0.2	-0.2	-0.1	0.0	-1.3
	MU	-1.0	-1.6	-0.1	-0.1	0.0	0.3	0.0	0.0
	QX	0.6	1.0	0.0	0.0	0.0	-0.1	0.0	0.0

КиевЗНИИЭП

ЛИСТ

1.220.1-3М.0-1.4 28МУ5

3

ФОРМАТ А4

загрузка		усилия							
		1	2	3	4	5	6	7	8
ЯРУС 4 СЕЧЕНИЕ 1									
1	N	0.0	0.0	0.0	0.0	0.3	0.2	0.0	0.0
	MX	0.5	0.4	-0.7	-0.5	0.0	0.0	0.0	0.5
	QY	-0.2	-0.2	0.2	0.2	0.0	0.0	0.0	-0.1
	MU	0.5	-0.7	0.4	-0.5	0.0	0.0	0.0	-0.3
	QX	0.2	-0.2	0.1	0.2	0.0	0.0	0.0	-0.1
8	N	0.0	0.0	0.0	0.0	0.0	-4.5	0.0	0.0
	MX	0.0	0.0	0.0	0.0	0.0	0.0	0.0	0.0
	QY	0.0	0.0	0.0	0.0	0.0	0.0	0.0	0.0
	MU	-0.1	-0.1	-0.1	-0.2	0.0	-0.2	0.0	-0.1
	QX	0.0	0.0	0.0	0.0	0.0	-0.1	0.0	0.0
9	N	0.0	0.0	0.0	0.0	5.2	0.0	0.0	0.0
	MX	0.1	0.2	0.1	0.2	0.2	-0.1	0.0	0.8
	QY	0.0	-0.1	0.0	-0.1	-0.1	0.1	0.0	-0.5
	MU	0.0	0.0	-0.1	0.0	0.0	0.0	0.0	-0.1
	QX	0.0	0.0	0.0	0.0	0.0	0.0	0.0	0.0
14	N	64.3	60.9	58.5	78.0	16.5	12.6	0.0	53.7
	MX	0.4	0.0	-1.0	0.5	-0.7	0.2	0.0	1.0
	QY	-0.3	0.0	0.7	-0.6	0.5	-0.2	0.0	-1.2
	MU	0.9	1.5	0.1	0.1	0.1	-0.6	0.0	0.0
	QX	0.5	-0.7	0.0	0.0	0.1	0.4	0.0	0.0
ЯРУС 4 СЕЧЕНИЕ 2									
1	N	0.0	0.0	0.0	0.0	-0.3	-0.2	0.0	0.0
	MX	-0.1	-0.1	0.2	0.1	0.0	0.0	0.0	-0.2
	QY	-0.2	-0.2	0.3	0.2	0.0	0.0	0.0	0.1
	MU	0.1	0.1	0.1	-0.1	0.0	0.0	0.0	0.0
	QX	0.2	0.2	-0.1	-0.2	0.0	0.0	0.0	0.0
8	N	0.0	0.0	0.0	0.0	0.0	4.5	0.0	0.0
	MX	0.0	0.0	0.0	0.0	0.0	0.0	0.0	0.0
	QY	0.0	0.0	0.0	0.0	0.0	0.0	0.0	0.0
	MU	0.0	0.0	0.0	0.0	0.0	-0.1	0.0	0.0
	QX	0.0	0.0	0.0	0.0	0.0	0.1	0.0	0.0
9	N	0.0	0.0	0.0	0.0	-5.2	0.0	0.0	0.0
	MX	0.0	0.0	0.0	0.0	0.2	-0.1	0.0	1.0
	QY	0.0	0.0	0.0	0.0	0.1	-0.1	0.0	0.5
	MU	0.0	0.0	0.0	0.0	0.0	0.0	0.0	0.0
	QX	0.0	0.0	0.0	0.0	0.0	0.0	0.0	0.0
14	N	-44.3	-60.9	-58.5	-78.0	-16.5	-12.6	0.0	-53.7
	MX	-0.5	0.0	-1.2	-1.7	-0.8	-0.5	0.0	-2.8
	QY	-0.3	0.0	-0.7	-0.6	-0.5	-0.2	0.0	-1.2
	MU	0.7	1.1	0.1	0.1	0.1	-0.6	0.0	0.1
	QX	-0.5	-0.7	0.0	0.0	-0.1	0.4	0.0	0.0

Безупоко
ОПЕРАТОР
СИСТЕМ
САПР
КиевЗНИИЭП

ИНВ № ПОДЛ
ПОДПИСЬ И ДАТА
ВЗАМ ИНВ №

ЛИСТ

1.220.1-3М.0-1.4 28МУ5

4

23171-04 143 ФОРМАТ А4

МАРКА ПОЗ.	ОБОЗНАЧЕНИЕ	НАИМЕНОВАНИЕ	КОП.	МАССА ЕД КГ	ПРИМЕЧАНИЕ
		ДОКУМЕНТАЦИЯ			
A3	I.220.I-3M.0-I.4 00TO	ТЕХНИЧЕСКОЕ ОПИСАНИЕ СБОРОЧНЫЕ ЕДИНИЦЫ РОСТВЕРК			
Ф1	I.220.I-3M.I-I 04	2Ф3-32	4	4275	
Ф2	I.220.I-3M.I-I 03	1Ф3-32	12	4390	
Ф3	I.220.I-3M.I-I 03	1Ф3-32	4	4390	
Ф4	I.220.I-3M.I-I 02	Ф2-32	6	2650	
Ф6		1ФД9-32	3		
Ф8		3ФД7-32	2		
		КОЛОННА			
K1	I.220.I-3M.2-I 04	КОЗТ 3.33-25.2	4	2797	
K2	I.220.I-3M.2-I 05-01	КДЗТ 3.33-25.3	6	2930	
K3	I.220.I-3M.2-I 04	КОЗС 3.33-25.2	7	2797	
K4	I.220.I-3M.2-I 08-04	КОФЗС 3.33-40.7	3	2856	
K5	I.220.I-3M.2-I 07-01	КДМЗТ 3.33-30.2	2	2842	
K6	I.220.I-3M.2-I 08-05	КДФЗС 3.33-40.7	3	2878	
K7	I.220.I-3M.2-I 08	КДФЗС 3.33-25.2	1	2744	
K8	I.220.I-3M.2-I 05	КДЗС 3.33-25.2	1	2865	
K9	I.220.I-3M.2-I 07-02	КДФЗС 3.33-25.2	2	2820	
K10	I.220.I-3M.2-I 01-02	КДЗС 3.33-25.1	6	1194	
K11	I.220.I-3M.2-I 05	КДЗС 3.33-25.2	1	2865	
		РИТЕЛЬ			
P1	I.220.I-3M.3-I 03-02	РДП4.53-50	9	2518	
P2	I.220.I-3M.3-I 01-01	РДП4.53-90ATV	19	2518	
P3	I.020-I/83.3-I 07-02	РОП 4.57-40	18	2070	
P4	I.020-I/83.3-I 02-03	РДП 4.57-70ATV	23	2600	
P9	I.220.I-3M.3-I 09	Р4.57-20	28	1710	
P10	I.020-I/83.3-I 07-01	РОП 4.57-30	9	2070	
P11	I.020-I/83.3-I 02-02	РДП 4.57-60ATV	4	2600	
I.220.I-3M.0-I.4 29					
НАЧ ОУД	Шевченко	ЗДАНИЕ ЗС 5.5-ЗАЛ(2x12)	СТАДИЯ	ЛИСТ	ЛИСТОВ
И КОНТР.	Егунюв		Р	1	2
ГЛ СПЕЦ.	Рудави		ГОСГРАЖДАНСТРОЙ		
ПРОВЕРИЛ	Зуенко		КиевЗНИИЭП		
РАЗРАБ.	Безгудово				

ФОРМАТ А4

МАРКА ПОЗ.	ОБОЗНАЧЕНИЕ	НАИМЕНОВАНИЕ	КОП.	МАССА ЕД КГ	ПРИМЕЧАНИЕ
		СВЯЗЕВАЯ ПЛИТА			
РП1	I.04I.I-2.I.200-01	ПК56.I2-8ATIUC(AIY)T-1	21	2000	
РП2	I.04I.I-2.I.400-02	ПК56.I5-8ATIUC(AIY)T-2	22	2600	
РП3	I.04I.I-2.I.400-01	ПК56.I5-6ATIUC(AIY)T-2	4	2600	
I.220.I-3M.0-I.4 29					

ОПЕРАТОР СИСТЕМ
САПР КиевЗНИИЭП

ИНВ № ПОДЛ
ПОДПИСЬ И ДАТА
ВЗАМ №ЗН №

ЛИСТ
2

23171-04 144 ФОРМАТ А4

МОНТАЖНЫЙ ПЛАН РОСТВЕРКОВ

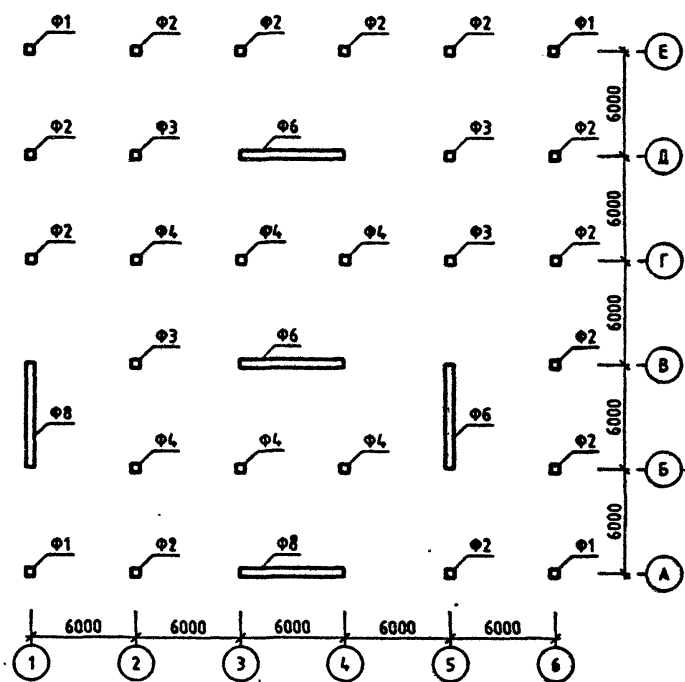

МОНТАЖНЫЙ ПЛАН КОЛОНН

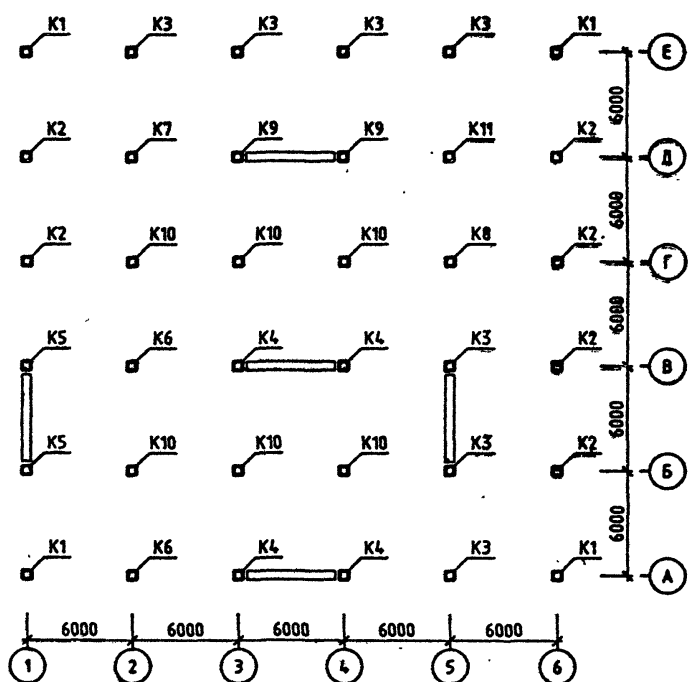

ОБОЗНАЧЕНИЕ	ШИФР ЗДАНИЯ
1.220.1-3М.0-1.4. 29	ЗС 5.5.30-ЗАЛ(2x12)32-3.5

1.220.1-3М.0-1.4 29СБ				
ЗДАНИЕ ЗС 5.5-ЗАЛ(2x12)		СТАДИЯ Р	ЛИСТ 1	ЛИСТОВ 3
Нач. отд. ГИП	Шевченко	ГОСГРАЖДАНСТРОЙ КиевЗНИИЭП		
Н.КОНТР.	Зуево			
ПРОВЕРИЛ	Бойко			
РАЗРАБ	Рудаків			

МОНТАЖНЫЙ ПЛАН РИГЕЛЕЙ

ОТМ. -0.82

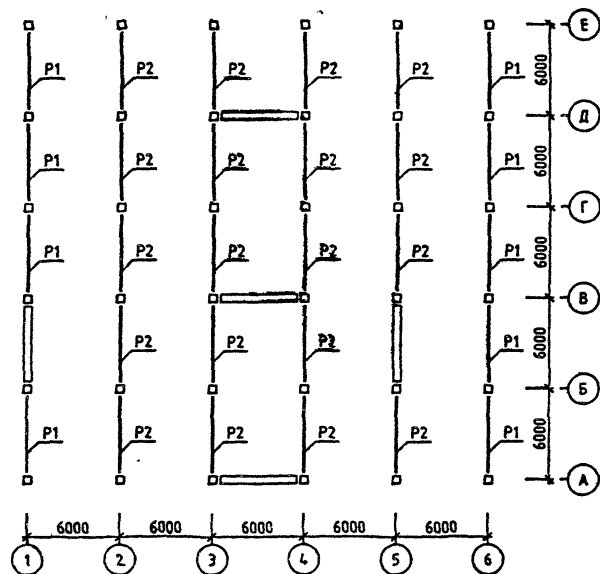

МОНТАЖНЫЙ ПЛАН РИГЕЛЕЙ И СВЯЗЕВЫХ ПЛИТ

ОТМ. +3.20

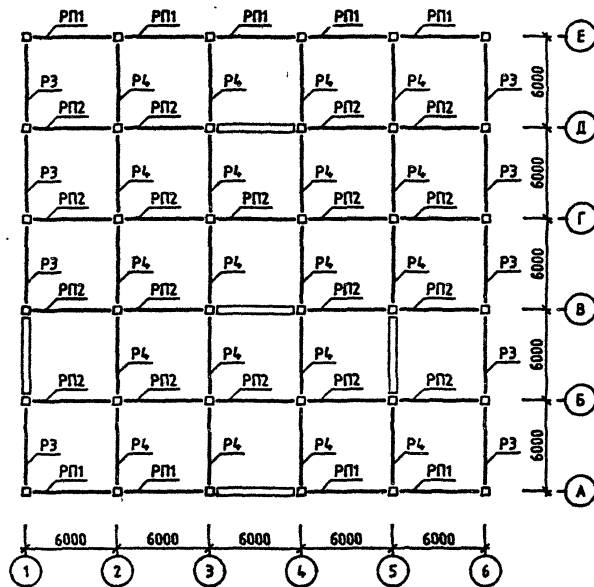

1.220.1-3М.0-1.4 290Б

ЛИСТ

2

23171-04 146 ФОРМАТ А3

МОНТАЖНЫЙ ПЛАН РИГЕЛЕЙ И СВЯЗЕВЫХ ПЛИТ

ОТМ. +6.50

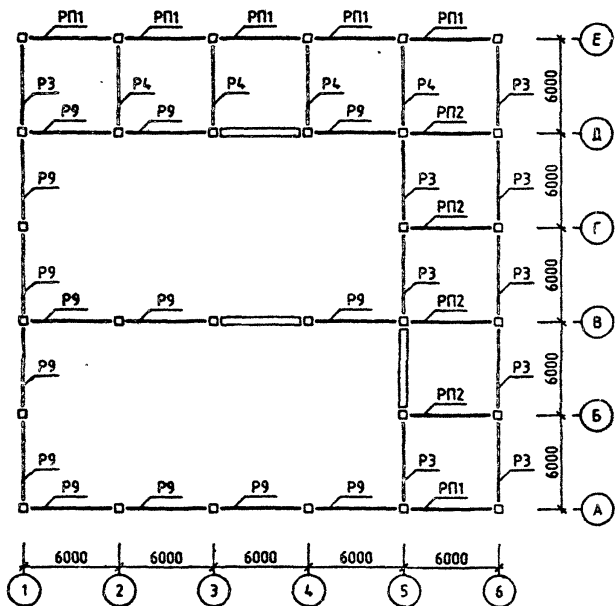

МОНТАЖНЫЙ ПЛАН РИГЕЛЕЙ И СВЯЗЕВЫХ ПЛИТ

ОТМ. +9.80

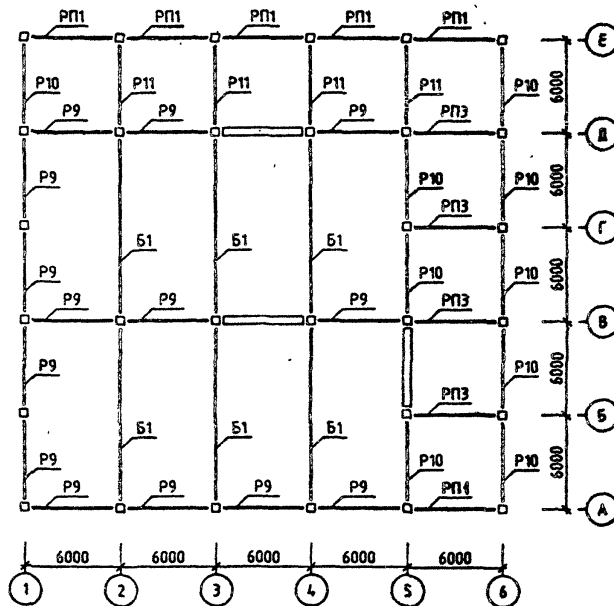

1.220.1-3М.0-1.4 29СБ

ЛИСТ
3

23171-04 147 ФОРМАТ А3

Номер загрузки	Тип усилия	Номер группы элементов								
		1	2	3	4	5	6	7	8	
ЯРУС 1 СЕЧЕНИЕ 1										
1	N	0.0	0.0	0.0	0.0	-18.6	-17.2	0.0	-17.4	
	MX	2.0	2.3	3.4	3.6	-11.5	5.3	0.8	-1.7	
	MY	-0.5	-0.5	-0.7	-0.7	6.6	-1.2	-0.1	0.3	
	MZ	1.6	2.6	1.6	2.5	-3.6	8.9	1.0	9.1	
	QX	-0.3	-0.5	-0.3	-0.4	-0.9	-5.0	0.1	2.6	
8	N	0.0	0.0	0.0	0.0	3.1	27.7	0.0	-14.3	
	MX	0.6	0.8	0.6	0.8	-0.9	1.0	-0.1	-0.9	
	MY	-0.2	-0.3	-0.2	-0.2	0.5	-0.5	0.0	-0.2	
	MZ	-0.3	-0.5	-0.7	-0.8	0.9	-7.4	-0.4	-8.0	
	QX	-0.1	-0.1	-0.2	-0.1	0.2	-4.3	0.0	0.1	
9	N	0.0	0.0	0.0	0.0	-35.4	-5.1	0.0	-3.5	
	MX	0.6	1.0	0.8	1.2	11.3	0.8	0.6	1.3	
	MY	-0.2	-0.2	-0.2	-0.2	-6.5	0.1	-0.1	-0.1	
	MZ	-0.6	-0.6	-0.8	-0.3	-1.7	-0.3	0.1	1.1	
	QX	0.1	0.0	-0.3	-0.1	-0.7	-0.2	0.0	0.5	
14	N	104.6	141.7	136.9	176.9	138.5	145.6	103.7	172.0	
	MX	-0.6	-0.3	-0.5	0.5	1.8	0.2	0.0	-2.1	
	MY	0.6	-0.1	1.1	-0.1	-1.3	-0.1	0.0	1.5	
	MZ	-0.7	-0.7	-0.1	-0.1	-1.3	-2.1	0.0	1.0	
	QX	-0.6	-1.0	0.0	0.0	-0.1	1.6	0.0	-0.3	
ЯРУС 1 СЕЧЕНИЕ 2										
1	N	0.0	0.0	0.0	0.0	18.6	17.2	0.0	17.4	
	MX	-0.5	-0.8	-1.1	-1.3	-11.6	-1.1	-0.5	0.6	
	MY	0.4	0.4	0.6	0.7	-6.6	1.2	0.1	-0.3	
	MZ	-0.4	-0.8	0.5	-0.9	-0.8	9.1	-0.5	9.4	
	QX	-0.4	-0.5	-0.3	0.4	0.9	-5.1	-0.1	2.2	
8	N	0.0	0.0	0.0	0.0	-3.1	-27.7	0.0	14.3	
	MX	0.2	0.1	0.1	0.0	-0.8	0.7	0.0	0.3	
	MY	0.2	0.3	0.2	0.0	-0.5	0.5	0.0	0.1	
	MZ	0.3	0.3	0.3	0.3	1.5	-7.7	0.2	-7.7	
	QX	0.1	0.1	0.2	0.1	-0.2	4.3	0.0	4.5	
9	N	0.0	0.0	0.0	0.0	35.4	5.1	0.0	3.5	
	MX	-0.4	-0.4	-0.4	-0.5	11.4	-1.3	-0.3	-0.9	
	MY	-0.2	-0.2	-0.1	0.2	6.5	-0.2	0.1	0.1	
	MZ	-0.2	-0.1	-0.1	0.0	-1.1	-0.4	0.0	1.0	
	QX	-0.1	0.0	-0.1	0.1	0.7	0.2	0.0	-0.5	
14	N	-104.6	-141.7	-136.9	-176.9	-138.5	-145.6	-103.7	-172.0	
	MX	-1.4	0.0	-3.5	0.0	2.8	0.1	0.0	-3.5	
	MY	-0.6	0.1	-1.1	0.1	1.3	0.1	0.0	-1.4	
	MZ	-1.6	2.9	0.0	0.0	-2.3	-3.6	0.0	1.7	
	QX	0.6	1.0	0.0	0.0	0.1	-1.6	0.0	0.0	
1.220.1-3М.0-1.4 29МУ										
ГИП	Егумов							СТАДИЯ	ЛИСТ	ЛИСТОВ
И КОНТР.	Бойко							г	1	3
РУК. ГР.	Рудови							ЗДАНИЕ		
ПРОВЕРИЛ	Футорная	30 5.5.90-ЗАИ(2*12)32-3.5						ГОСГРАЖДАНСТРОЙ		
РАЗРАБ	Зучинко							КиевЗНИИЭП		

Номер загрузки	Тип усилия	Номер группы элементов								
		1	2	3	4	5	6	7	8	
ЯРУС 2 СЕЧЕНИЕ 1										
1	N	0.0	0.0	0.0	0.0	4.1	3.4	0.0	1.9	
	MX	0.5	0.8	1.1	1.3	0.1	0.5	0.5	-0.6	
	MY	-0.4	-0.4	-0.6	-0.7	0.0	-0.3	-0.1	0.3	
	MZ	0.4	0.8	-0.5	0.9	-0.3	0.0	0.5	0.9	
	QX	0.4	0.5	0.3	-0.4	-0.2	0.0	0.1	0.3	
8	N	0.0	0.0	0.0	0.0	2.6	10.8	0.0	3.6	
	MX	-0.2	-0.1	-0.1	0.0	0.1	0.1	0.0	-0.1	
	MY	-0.2	-0.3	-0.2	0.0	-0.1	-0.2	0.0	-0.2	
	MZ	-0.3	-0.3	-0.3	-0.3	-0.1	-0.3	-0.2	-0.3	
	QX	-0.1	-0.1	-0.2	-0.1	0.0	-0.1	0.0	0.2	
9	N	0.0	0.0	0.0	0.0	12.1	-3.0	0.0	-2.9	
	MX	0.4	0.4	0.4	0.5	0.3	0.2	0.3	0.5	
	MY	0.2	0.2	0.1	-0.2	-0.1	0.0	-0.1	0.1	
	MZ	0.2	0.1	0.1	0.0	-0.1	-0.1	0.0	0.1	
	QX	0.1	0.0	0.1	-0.1	-0.3	0.0	0.0	-0.2	
14	N	67.0	93.2	89.5	117.2	39.5	42.7	44.1	112.3	
	MX	1.5	0.0	2.9	0.0	0.3	0.1	0.0	-2.8	
	MY	-0.5	-0.1	-1.1	-0.1	-0.2	-0.1	0.0	1.4	
	MZ	1.6	-2.5	0.0	0.0	-0.8	0.4	0.0	-0.2	
	QX	0.6	-1.0	0.0	0.0	-0.2	0.1	0.0	0.0	
ЯРУС 2 СЕЧЕНИЕ 2										
1	N	0.0	0.0	0.0	0.0	-4.1	-3.4	0.0	-1.9	
	MX	1.5	1.2	1.7	1.5	0.1	1.0	0.0	-0.7	
	MY	0.5	0.5	0.7	0.7	0.0	0.3	-0.1	-0.3	
	MZ	1.2	1.4	0.9	1.0	-0.7	0.0	0.0	1.0	
	QX	0.3	0.5	0.3	0.4	0.2	0.0	0.0	-0.3	
8	N	0.0	0.0	0.0	0.0	-2.6	-10.8	0.0	-3.6	
	MX	1.2	1.2	0.9	1.0	0.2	0.7	0.0	1.0	
	MY	0.2	0.3	0.2	0.2	0.1	0.2	0.0	0.2	
	MZ	1.2	0.9	1.2	-0.3	1.1	-0.2	0.0	1.2	
	QX	0.1	0.1	0.2	0.1	-0.1	0.1	0.0	-0.1	
9	N	0.0	0.0	0.0	0.0	-12.1	3.0	0.0	2.9	
	MX	-1.1	-1.1	-0.8	-0.8	-0.2	-0.6	0.0	-1.4	
	MY	-0.2	-0.2	-0.1	-0.1	-0.1	-0.1	0.1	-0.2	
	MZ	-1.2	-1.0	-1.2	-0.4	-1.1	-0.1	0.0	-1.3	
	QX	-0.1	0.0	-0.1	0.0	0.1	0.0	0.0	0.3	
14	N	-67.0	-93.2	-89.5	-117.2	-39.5	-42.7	-44.1	-112.3	
	MX	-0.9	0.4	-1.9	0.5	0.7	0.2	0.0	-3.2	
	MY	-0.6	0.1	-1.1	0.1	0.2	0.1	0.0	-1.4	
	MZ	-1.2	-2.0	-0.1	-0.1	-0.7	0.0	0.0	-0.8	
	QX	0.6	1.0	0.0	0.0	0.2	-0.1	0.0	0.0	
1.220.1-3М.0-1.4 29МУ										
ИНВ. ПОДП.	ПОДПИСЬ И ДАТА	ВЗАИМН. ИМЯ								ЛИСТ
										2

Номер загрузки	Тип усилия	Номер группы элементов							
		1	2	3	4	5	6	7	8
ЯРУС 3 СЕЧЕНИЕ 1									
1	RBCN	0.0	0.0	0.0	0.0	1.5	1.1	0.0	0.0
		-1.5	-1.2	-1.7	-1.5	0.8	-1.0	0.0	0.0
		0.5	0.4	0.6	0.5	-0.4	0.4	0.0	-0.1
		-1.2	-1.4	-0.9	-1.0	-2.0	-0.1	0.0	-1.0
		0.4	0.5	0.2	0.4	-0.7	0.0	0.0	
8	RBCN	0.0	0.0	0.0	0.0	1.4	-5.8	0.0	0.5
		-1.2	-1.2	-0.9	-1.0	-3.4	-0.7	0.0	-1.0
		0.1	0.1	0.1	0.1	0.9	0.1	0.0	0.2
		-1.2	-0.9	-1.2	0.3	-2.4	-0.2	0.0	-4.3
		0.1	0.1	0.1	-0.4	-0.1	0.0	-0.1	
9	RBCN	0.0	0.0	0.0	0.0	-6.3	-1.8	0.0	-0.5
		1.1	1.1	0.8	0.8	4.5	0.6	0.0	1.8
		-0.1	-0.1	-0.1	-0.1	-1.4	-0.1	0.0	-0.7
		1.2	1.0	1.2	0.4	1.6	-0.1	0.0	3.6
		0.0	0.0	-0.1	0.0	0.0	0.0	1.0	
14	RBCN	44.3	60.9	58.5	73.2	38.3	15.0	0.0	68.3
		0.1	-0.4	0.2	-0.5	-1.3	-0.3	0.0	1.8
		-0.3	0.6	-0.4	0.7	0.6	0.3	0.0	-1.3
		0.8	-2.0	0.1	0.1	-2.3	0.5	0.0	1.3
		-0.4	-0.6	0.1	0.0	-0.7	-0.3	0.0	0.5
ЯРУС 3 СЕЧЕНИЕ 2									
1	RBCN	0.0	0.0	0.0	0.0	-1.5	-1.1	0.0	0.0
		0.4	-0.2	-0.3	-0.2	0.4	-0.2	0.0	-0.4
		0.4	-0.4	-0.6	-0.5	0.4	-0.4	0.0	0.1
		-0.4	0.5	-0.2	-0.3	0.6	0.0	0.0	-0.3
		0.5	-0.5	-0.2	-0.4	0.7	0.0	0.0	0.0
8	RBCN	0.0	0.0	0.0	0.0	-1.4	5.8	0.0	-0.5
		1.0	0.9	0.6	0.6	0.4	0.2	0.0	0.5
		0.0	-0.1	-0.1	-0.1	-0.9	-0.1	0.0	-0.2
		0.8	-1.0	0.7	0.2	0.3	-0.2	0.0	0.8
		0.1	0.6	-0.1	-0.1	0.8	0.1	0.0	0.1
9	RBCN	0.0	0.0	0.0	0.0	6.3	1.8	0.0	0.5
		-0.8	-0.8	-0.5	-0.5	0.2	-0.1	0.0	0.8
		0.1	0.1	0.1	0.1	0.1	0.1	0.0	0.6
		-1.0	-0.6	-1.0	-0.2	-0.8	0.0	0.0	-1.0
		-0.1	-0.1	0.1	0.0	-0.1	0.0	-1.0	
14	RBCN	-44.3	-60.9	-58.5	-73.2	-38.3	-15.0	0.0	-68.3
		0.8	-1.7	1.0	-1.9	-0.6	-0.7	0.0	2.9
		0.3	-0.6	0.4	-0.7	-0.3	-0.3	0.0	1.2
		0.7	-2.5	0.2	0.1	-2.3	0.5	0.0	0.4
		0.4	0.6	-0.1	0.0	-0.1	0.3	0.0	0.0

1.220.1-3M.0-1.4 29МУ

ЛИСТ

3

ФОРМАТ А4

Номер загрузки	Тип усилия	Номер группы элементов							
		1	2	3	4	5	6	7	8
(Empty table content)									

ИНВ № ПОДП

ПОДПИСЬ И ДАТА

ВЗАМ ИНВ №

САПР
КиевЭНИИЭП

ОПЕРАТОР
СИСТЕМ

Безудова

Без

ЛИСТ

23171-04 (149)

ФОРМАТ А4